

**HANSA FLEX**



Sealing Technology



## Hose Replacement Service – 24h hour rapid response

Our 280 service vans from the hydraulic emergency service are always just a call away. Whether on the construction site, during the harvest or in industrial applications: in case of a machine failure the job is carried out on site – and around the clock.

Tel. 24/7: 0800 77 12345 (Int. +49 421 9897 7690)



## Industrial Service – maintain and optimise

Your machines must be running, around the clock. Preventative maintenance of the HANSA-FLEX Industrial Services helps you to save money and guarantees maximum machine uptime. We will advise you from the selection of the right hydraulic components to the optimisation of your plant and machinery.

[www.hansa-flex.com/en/industrial\\_service](http://www.hansa-flex.com/en/industrial_service)



## Power Unit Construction – engineering from the specialist

Units are the heart of any hydraulic system. In order to produce a state of the art power unit a high degree of engineering skill is required. The HANSA-FLEX power unit construction offers all services as a single source: from planning, design to installation and commissioning at the customer site.

[www.hansa-flex.com/en/unit\\_manufacture](http://www.hansa-flex.com/en/unit_manufacture)



## Online Shop – 24/7 convenient shopping

In our online shop you will find the same variety and quality of products that our customers have been used to for over 50 years: from hydraulic hoses and hose fittings to couplings, ball valves and cylinders – “everything from a single source.”

[www.hansa-flex.com/en/shop](http://www.hansa-flex.com/en/shop)



## X-CODE – hose management

Our customer portal My.HANSA-FLEX offers the perfect solution for preventative maintenance. Users can see the technical data of a hose line at a glance: Manufacturing date, period of use, proposed replacement date, as well as machine and location. Thus, inspection and maintenance intervals can be planned well ahead.

[www.hansa-flex.com/en/hose\\_line\\_management](http://www.hansa-flex.com/en/hose_line_management)











## HANSA-FLEX – always close to our customers

Through our tight-knit network of branches we are always close to our customers. At each of our 400 locations we offer the complete range of hydraulics: from the standard replacement of a hose line to powerful hydraulic cylinders – personal, fast and reliable.

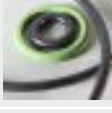
[www.hansa-flex.com/en/subsidiaries](http://www.hansa-flex.com/en/subsidiaries)

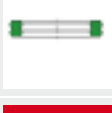
## Sealing technology

	Technical Information Page 10	T
	Hydraulic seals Page 40	1
	Pneumatic seals Page 134	2
	Seal kits and measuring equipment Page 144	3
	Static seals Page 152	4
	Flat seals Page 200	5
	Sealing rings Page 206	6
	Moulded parts Page 218	7
	Subject Index / Index Page 222	I

We reserve the right to amend the information contained in this catalogue without notice. The information contained in this catalogue is based on many years of experience; however, the technical information shall not be binding on us. Because technical problems are always specific to the case in question, we are available to provide you with advice at any time.

The information and illustrations in this catalogue are provided solely for the purpose of describing the products. They shall not be interpreted as guaranteed characteristics in the legal sense. Despite the most careful checking, we cannot exclude the possibility of mistakes in the catalogue and we accept no liability for the information it contains.

All rights reserved by HANSA-FLEX AG. Reproduction is permitted only with our written permission. The publication of this catalogue supersedes the information in previous editions.

# 1. Hydraulic seals

## Rod seals



Rod seals B  
Page 42

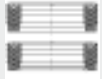

Chevron ring, CH  
Page 47



Rod U-ring, DDI, DDIM, DDIM-P  
Page 51



U-rings, DUM, DUM-N  
Page 53



Rod U-ring, EU, EU-I  
Page 55

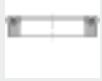

Rod seals EUS-I  
Page 57



Rod seals IBU, IBF  
Page 58



Rod packing set, IGR-B, IGRL-B  
Page 59



PUR, U-rings  
Page 62



Rod U-ring, RS-L, RS-LA  
Page 65



Rod packing set, SM, SM-M  
Page 67



Rod U-ring, TS, TS AI, TS-L, TS-LA  
Page 68

## Piston seals



Piston seals, B-NEO, B-NWO, B-NWO-KR  
Page 71



Chevron ring, CH3  
Page 73



Sets of groove ring seals type D11W  
Page 74



Piston seals, DAS, DBM, DBM-NEO  
Page 75



Piston groove rings type DDE, DDEM, DDEM-P  
Page 78



Sets of groove ring seals type Typ DPC  
Page 80



Sets of groove ring seals type DPS, DPS-SI  
Page 81



Sets of groove ring seals type DS, DS-NEO, DS-M  
Page 83



Piston seals, DSM  
Page 85



U-rings, DUM, DUM-N  
Page 86



Sets of groove ring seals type EGR-A  
Page 87



Sets of groove ring seals type EUD, EUD-P  
Page 88



Sets of groove ring seals type GPK  
Page 89



Sets of groove ring seals type GPS  
Page 90



U-rings, MU  
Page 91



Sets of groove ring seals type PHD, PHD-PU  
Page 92



Piston groove rings type RSE, RSE-AE  
Page 93



Piston groove rings type RSE-W, RSE-W-AR  
Page 94

# 1. Hydraulic seals



Complete pistons pneumatics type TDO  
Page 96

## Wipers

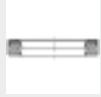

Wipers type DR  
Page 97



Wipers type DSR, DSR-P  
Page 98



Wipers type DSR-U, DSR-UP  
Page 100

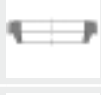

Wipers type GA, GA-FPM  
Page 102



Wipers type GA-R  
Page 103



Wipers type NW  
Page 105



Piston wipers type PPW  
Page 106



Wipers type PW-G, PW-U  
Page 107



Wipers type SWP, SWP-I  
Page 108



Double wiper type UWR, UWR-P  
Page 109

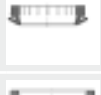

Wipers type WAH, WUH  
Page 110



Wipers type WRM, WRM-FPM, WRM-H, WRM-P, WRM-PI  
Page 111



Wipers type WRS  
Page 114



Wipers type WTF-A, WTF-B  
Page 115



Wipers type WTF-B, WTF-BPU  
Page 116

## Guide rings



Guide rings type E-DWR, I-DWR  
Page 117



Guide rings type E-GTP, I-GTP  
Page 119



Guide rings type E-GTP1, I-GTP1  
Page 120



Guide band GT, GTH  
Page 122



Piston guide rings type WP  
Page 124



Piston guide rings type WR  
Page 125

## Bushes

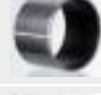









slide bush type BK-1, BK-1 F, BK-2  
Page 126



slide bush type BK 090, BK 090-F  
Page 131

## 2. Pneumatic seals

Rod seals Pneumatic	
	Damping seals type CIM Page 136
	Rod U-ring, DDI, DDIM, DDIM-P Page 137
	U-rings, DUM, DUM-N Page 139
	Rod wiper seals type NPSL, NPSL-P Page 140
Piston seals Pneumatic	
	Piston groove rings type DDE, DDEM, DDEM-P Page 141
	U-rings, DUM, DUM-N Page 142
	Sets of groove ring seals type GPP Page 142
	Complete pistons pneumatics type TDOP Page 142

## 3. Seal kits and measuring equipment

### Seal kits



Packing sets for single-acting HF cylinders  
Page 146



Packing sets for double-acting HF (high-flow)  
cylinders  
Page 147



Packing sets for guide heads wide  
Page 148

### measuring equipment



measuring equipment  
Page 149



Installation Tools  
Page 150

## 4. Static seals

### O-rings



NBR O-rings  
Page 154



Viton O-rings  
Page 175



EPDM O-rings  
Page 181



Silicone O-rings  
Page 181



O-ring cord  
Page 182



O-ring assortments  
Page 183

### Quad rings



NBR quad rings  
Page 186

### Support rings



NBR support rings  
Page 187



PTFE support rings  
Page 189



Polyester support ring  
Page 191

### Usit rings



NBR/steel Usit ring  
Page 195

### Flange seals



PUR SAE flange seal  
Page 198



## 5. Flat seals

### Flat seals asbestos-free



Flat seals FD C4400  
Page 202



Flat seals FD  
Page 203



Sealing plates  
Page 204

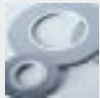

Flat seals graphite/serrated perforated plate  
Page 204

## 6. Sealing rings

### Aluminium



Aluminium sealing rings  
Page 208

### Copper



Copper sealing rings  
Page 210



CAR sealing rings  
Page 213

### Vulcanised fibre



Vulcanised fibre sealing rings  
Page 215

## 7. Moulded parts

### Form sealing rings



Form sealing rings PU  
Page 220

T

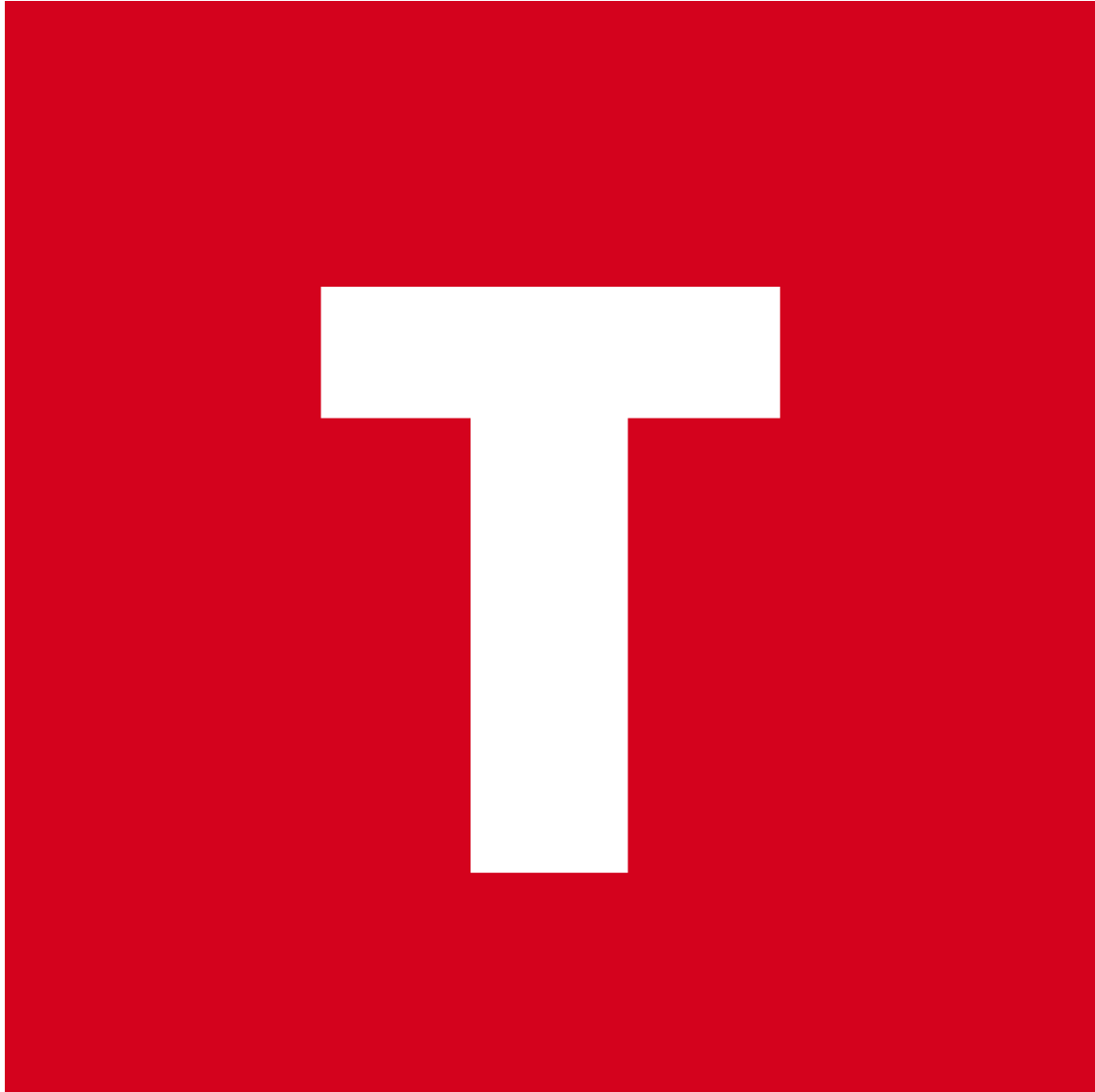

## Technical information

# TECHNICAL INFORMATION SEALS AND SEALING EQUIPMENT

T

## TABLE OF CONTENTS

- 1. INSTALLATION INSTRUCTIONS**
  - 1.1 Rod seals and wipers
  - 1.2 Piston seals and guide rings
  - 1.3 Static seals – Radial installation
  - 1.4 Static seals – Axial installation
- 2. CORRECT INSTALLATION**
- 3. TABLE OF INTERNATIONAL STEEL GRADES AND THEIR EQUIVALENTS**
- 4. STORAGE CONDITIONS FOR ELASTOMERS**
- 5. TOLERANCES AND FITS**
- 6. SURFACE QUALITY PARAMETERS FOR SEAL HOUSINGS**
- 7. ABBREVIATIONS USED FOR MATERIALS IN HF SEALS**
- 8. BUSHES**
  - 8.1 General
  - 8.2 Maintenance-free bushes type BK-1
  - 8.3 Maintenance-free bushes type BK-2
  - 8.4 Bronze bushes type BK090
- 9. O-RINGS**
  - 9.1 Description of O-rings
  - 9.2 Principle of O-rings
  - 9.3 Technical features of O-rings
  - 9.4 Permissible clearance gap of O-rings
  - 9.5 Dimensional tolerances for O-rings in accordance with ISO 3601-1:2008 Class B
  - 9.6 Static seal of O-rings
  - 9.7 Dynamic seal for pneumatic cylinders
  - 9.8 Dynamic seal for hydraulic cylinders
  - 9.9 Installation instructions for O-rings
- 10. BACK-UP RINGS**
  - 10.1 Extrusion
  - 10.2 Profiles and materials
  - 10.3 Further information
- 11. FLAT SEALS**
  - 11.1 Flat seals in accordance with EN1514-1 (DIN 2690, 2691, 2692)
  - 11.2 Dimensions and tolerances for sealing plates, cut plates and punched articles
- 12. ON-DEMAND SEAL PRODUCTION**
- 13. SEAL PROFILES**
- 14. MATERIAL DATASHEET**

# 1. INSTALLATION INSTRUCTIONS

## 1.1 ROD SEALS AND WIPERS

### Surface quality

The roughness values stated in table 1.1 must be observed in both the  $R_a$  and  $R_t$  areas.

### Open or closed grooves

Table 1.2 can be used to establish whether a seal can be fitted in closed grooves (1). In the case of a specific cross-section B, we recommend fitting in open grooves (2) if the diameter of the rod is less than the minimum diameter ( $d_{min}$ ).

### Chamfers

Table 1.3 lists the chamfer lengths K to be observed.

### Roundings

Sharp edges must be avoided. Table 1.4 lists the radii to be observed.

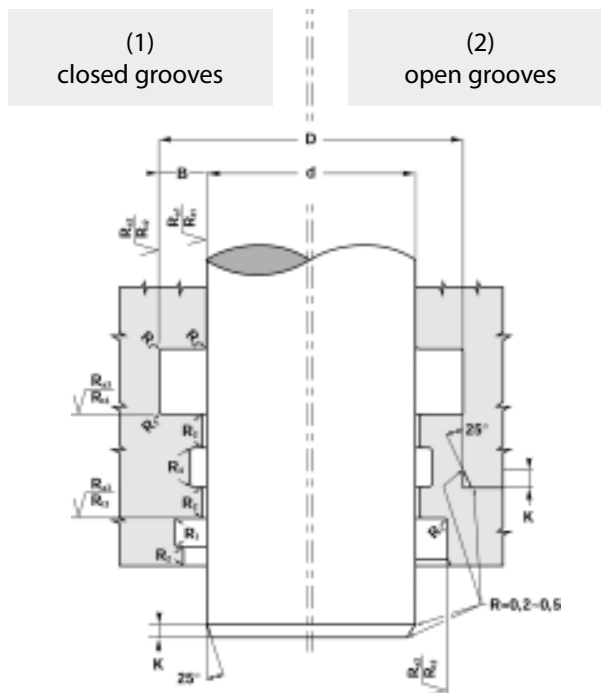

$R_{a1}$	$R_{t1}$	$R_{a2}$	$R_{t2}$	$R_{a3}$	$R_{t3}$
$\leq 0.3 \mu\text{m}$	$\leq 3 \mu\text{m}$	$\leq 1.8 \mu\text{m}$	$\leq 10 \mu\text{m}$	$\leq 3 \mu\text{m}$	$\leq 16 \mu\text{m}$

B (mm)	4	5	6	7.5	10	12.5	15
$d_{min}$ (mm)	30	40	50	65	80	150	200

$K \text{ (mm)} = 0.6 B$
--------------------------

B (mm)	$R_t$ (mm)	$R_2$ (mm)	$R_4$ (mm)
$\leq 7.5$	$\leq 0.3$	0.2	$\leq 0.2$
$> 7.5$	$\leq 0.6$	0.4	

## 1.2 PISTON SEALS AND GUIDE RINGS

### Surface quality

The roughness values stated in table 1.1 must be observed in both the  $R_a$  and  $R_t$  areas.

### Single or multipart pistons

Please refer to the "Installation" instructions in this catalogue for each seal profile and each individual seal.

### Chamfers

Table 1.3 lists the chamfer lengths K to be observed.

### Roundings

Sharp edges must be avoided. Table 1.5 lists the radii to be observed.

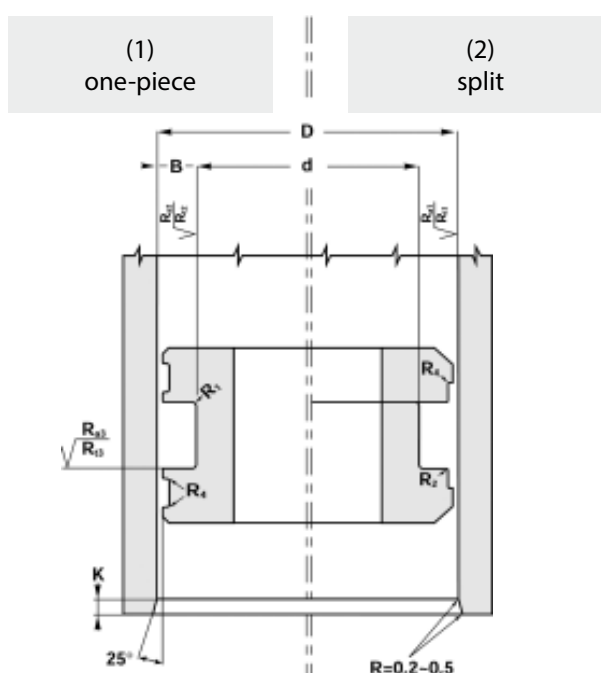

B (mm)	R <sub>1</sub> (mm)	R <sub>2</sub> (mm)	R <sub>3</sub> (mm)	R <sub>4</sub> (mm)
≤ 7.5	≤ 0.3	0.2	≤ 2	≤ 0.2
> 7.5	≤ 0.6	0.4	≤ 4	

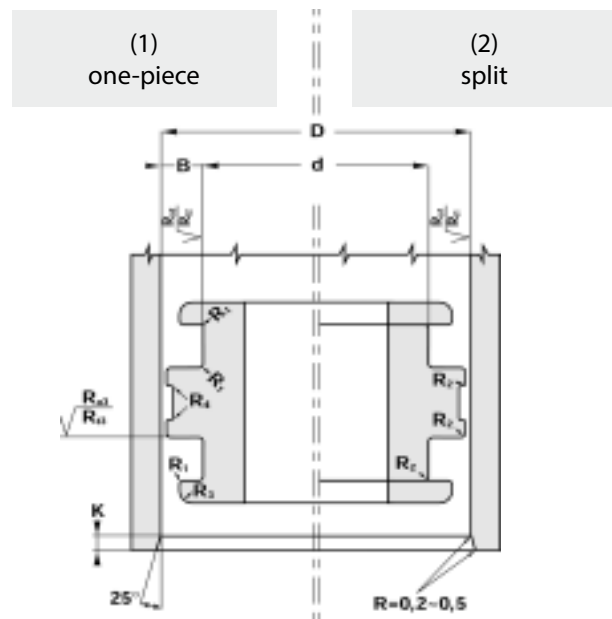

### 1.3 STATIC SEALS – RADIAL INSTALLATION

The static seal is squeezed between its external and internal diameters.

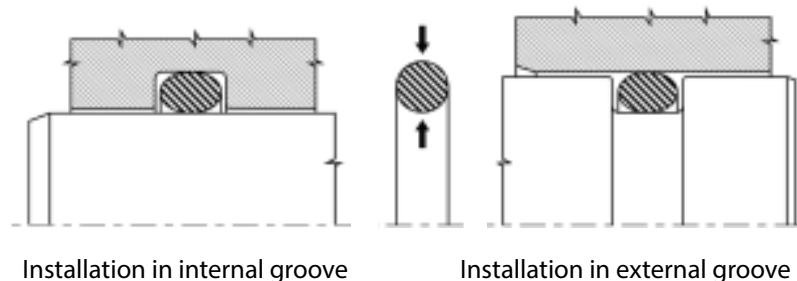

### 1.4 STATIC SEALS – AXIAL INSTALLATION

The static seal is squeezed between its two side faces.

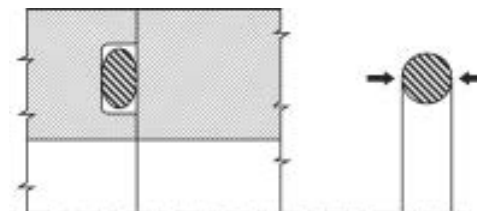

## 2. CORRECT INSTALLATION

Hydraulic seals can be damaged if they are not correctly installed. This can result in many problems, which can be avoided by observing the following guidelines:

- Check that the groove diameters, tolerances, surface qualities and chamfers are based on the values given in this catalogue.
- Ensure that the seal does not come in contact with sharp edges, bored holes or threads during assembly.
- All metal parts must be absolutely clean and free of swarf, weld splatter and defects.
- All seals must be lubricated before assembly with the same liquid or a liquid compatible with that which will be used in the hydraulic system.
- Do not use sharp-edged tools for installation. Do not allow seals to be deformed for a prolonged period during installation.
- Ensure the seal is correctly oriented with respect to the direction of fluid pressure. The same applies to all the other parts.

### 3. TABLE OF INTERNATIONAL STEEL GRADES AND THEIR EQUIVALENTS

---- Germany ----		Steel microstructure	Tensile strength	Breaking elongation	USA	France	England	Italy	Sweden	Japan	
Wk.No.	DIN	Type									
1.4113	X 6 CrMo 17-1	F1	ferritic	450/630	18	434	-	434 S 17	X 8 CrMo 17	-	SUS 434
1.4016	X 8 Cr 17	F1	ferritic	450/630	20	430	Z 8 C 17	430 S 17	X 8 Cr 17	2320	SUS 430
1.4006	X 10 Cr 13	C1	martensitic	730	20	410	Z 10 C 13	410 C 21	X 10 Cr 13	2302	SUS 410
1.4021	X 20 Cr 13	C1	martensitic	800/950	12	420	Z 20 C 13	420 S 37	X 20 Cr 13	2303	SUS 420 J1
1.4028	X 30 Cr 13	C1	martensitic	850/1000	10	420 F	Z 30 C 13	420 S 45	X 30 Cr 13	2304	SUS 420 J2
1.4057	X17 CrNi 16-2	C3	martensitic	800/950	12	431	Z 15 CN 10-02	431 S 31	X 16 CrNi 16	-	SUS 431
1.4125	X 105 CrMo 17	C3	martensitic	-	-	440 C	Z 100 CD 17	-	-	-	SUS 440 C
1.4305	X 8 CrNi 18-9	A1	austenitic	500/700	35	303	Z 8 CNF 18-09	303 S 22	X 10 CrNiS 18 09	2346	SUS 303
1.4301	X 5 CrNi 18-10	A2	austenitic	540/750	45	304	Z 6 CN 18-09	304 S 17	X 5 CrNi 18 10	2332	SUS 304
1.4303	X 4 CrNi 18-12	A2	austenitic	500/650	45	305	Z 5 CN 18-11	305 S 19	X 7 CrNi 18 10	-	SUS 305
1.4306	X 2 CrNi 19-11	A2	austenitic	520/670	45	304 L	Z 2 CN 18-10	304 S 11	X 2 CrNi 18 11	2352	SUS 304 L
1.4541	X CrNiTi 18-10	A2	austenitic	520/720	40	321	Z 6 CNT 18-10	321 S 31	X 6 CrNiTi 18 11	2337	SUS 321
1.4550	X 6 CrNiNb 18-10	A2	austenitic	520/720	40	347	Z 6 CNNb 18-10	347 S 20	X 6 CrNiNb 18 11	2338	SUS 347
1.4401	X 5 CrNiMo 17-12-2	A4	austenitic	530/680	40	316	Z 7 CND 17-11-02	316 S 17	X 5 CrNi Mo 17 12	2347	SUS 316
1.4404	X 2 CrNiMo 17-12-2	A4	austenitic	530/680	40	316 L	Z 3 CND 17-11-02	316 S 11	X 2 CrNi Mo 17 12	2348	SUS 316 L
1.4435	X 2 CrNiMo 18-14-3	A4	austenitic	500/700	40	316 L	Z 3 CND 17-11-03	316 S 14	X 2 CrNi Mo 17 13	2353	SUS 316 L
1.4436	X 3 CrNi Mo 17-13-3	A4	austenitic	550/700	40	316	Z 6 CND 18-12-03	316 S 19	X 5 CrNi Mo 17 13	2343	SUS 316
1.4438	X 2 CrNiMo 18-15-4	A4	austenitic	550/700	40	317 L	Z 2 CND 19-15-04	317 S 12	X 5 CrNi Mo 17 13	2343	SUS 316
1.4539	X 1 NiCrMoCuN 25-20-5	A4	austenitic	530/730	35	904 L	Z 2 NCDU 25-20	-	-	2562	-
1.4571	X 6 Cr NiMoTi 17-12-22	A4	austenitic	450/690	40	316 Ti	Z 6 CNDT 17-12	320 S 18	X 6 CrNi MoTi 17 12	2350	SUS 316 Ti
1.4580	X 6 CrNiMoNb 17-12-2	A4	austenitic	450/690	40	316 Cb	Z 6 CNDNb 17-12	318 S 17	X 6 CrNi MoNb 17 12	-	-

### 4. STORAGE CONDITIONS FOR ELASTOMERS

- Max. 25 °C
- Keep away from direct sources of heat
- Keep out of direct sunlight
- Install low-UV lighting
- Max. air humidity 60 % prevent condensation occurring
- Keep away from ionizing radiation and the effects of ozone, for example produced by welding work
- Store in a PE bag or the original packaging
- Do not store hung up on a hook or similar

Shelf lives of elastomers		
Material	Initial storage	Extension storage
Polyurethane, SBR	5 years	2 years
NBR, HNBR	7 years	3 years
FPM, FFKM, EPDM, VMQ	10 years	5 years

#### INSPECT AFTER THE INITIAL PERIOD OF STORAGE

##### Visual inspection:

- Deformation, cuts, surface cracks (use a 10 x magnifying glass)
- Hardening, softening, discolouration, contamination
- Permanent deformations, creases, flat areas



## 5. TOLERANCES AND FITS

Table of ISO tolerances basic hole / basic shaft in accordance with ISO 286.

The allowances for shafts are given in accordance with DIN 7160; for holes the standard is DIN 7161.

### ALLOWANCES FOR HOLES AND SHAFTS

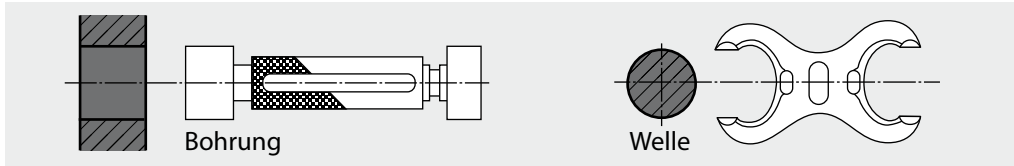

The ISO system for tolerances and fits relate to all linear parameters such as external dimensions, internal dimensions, diameters, lengths, widths, heights and thicknesses.

A reference temperature 20 °C applies to all the dimensions defined in this system. Tables 5.1, 5.2 and 5.3 contain a selection of tolerances that are used successfully in the field of tool and mould making, and are the preferred values in HASCO standards. These tolerances are used in our technical documents to precisely describe our products. These tolerances can also be used to advantage in other areas.

### TOLERANCES FOR INTERNAL DIMENSIONS (HOLES)

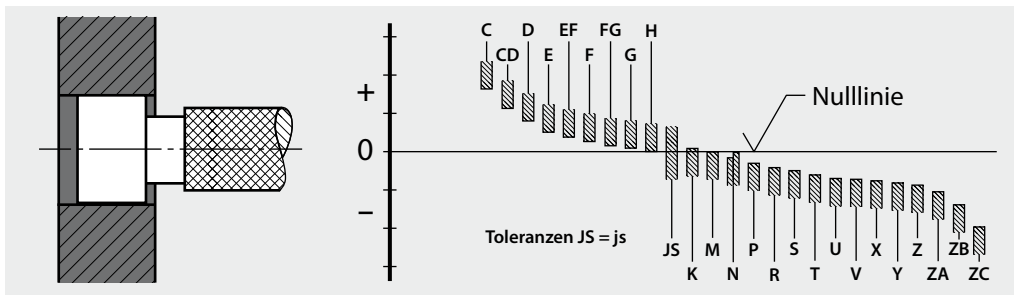
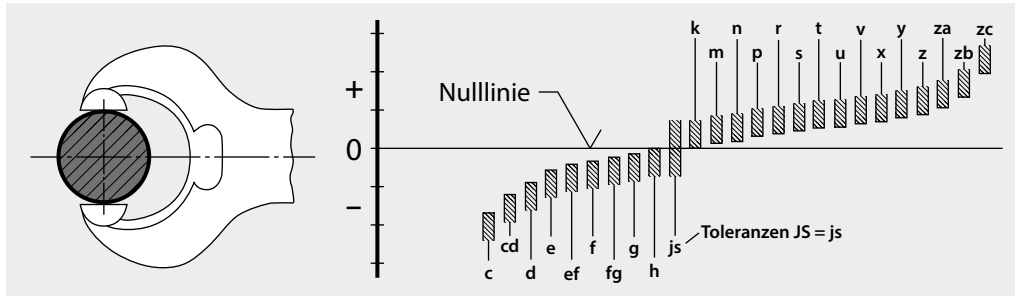

Table 5.1 – Extract from DIN 7161, allowances in  $\mu\text{m}$  (0.001 mm)

Symbol	F6	F7	F8	G6	G7	H5	H6	H7	H8	H9	H10	H11	H12	H13	K6	K7	K8	JS
Nominal size range (mm)	3	+12	+16	+20	+8	+12	+4	+6	+10	+14	+25	+40	+60	+100	+104	0	0	0
		+6	+6	+6	+2	+2	0	0	0	0	0	0	0	0	0	-6	-10	-14
	3 – 6	+18	+22	+28	+12	+16	+5	+8	+12	18	+30	+48	+75	+120	+180	+2	+3	+5
		+10	+10	+10	+4	+14	0	0	0	0	0	0	0	0	0	-6	-9	-13
	6 – 10	+22	+28	+35	+14	+20	+6	+9	+15	+22	+36	+58	+90	+150	+220	+2	+5	+6
		+13	+13	+13	+5	+5	0	0	0	0	0	0	0	0	0	-7	-10	-16
	10 – 18	+27	+34	+43	+17	+24	+8	+11	+18	+27	+43	+70	+110	+180	+270	+2	+6	+8
		+16	+16	+16	+6	+6	0	0	0	0	0	0	0	0	0	-9	-12	-19
	18 – 30	+33	+41	+53	+20	+28	+9	+13	+21	+33	+52	+84	+130	+210	+330	+2	+6	+10
		+20	+20	+20	+7	+7	0	0	0	0	0	0	0	0	0	-11	-15	-23
	30 – 50	+41	+50	+64	+25	+34	+11	+16	+25	+39	+62	+100	+160	+250	+390	+3	+7	+12
		+25	+25	+25	+9	+9	0	0	0	0	0	0	0	0	0	-13	-18	-27
	50 – 80	+49	+60	+76	+29	+40	+13	+19	+30	+46	+74	+120	+190	+300	+460	+4	+9	+14
		+30	+30	+30	+10	+10	10	0	0	0	0	0	0	0	0	-15	-21	-32
	80 – 120	+58	+71	+90	+34	+47	+15	+22	+35	+54	+87	+140	+220	+350	+540	+4	+10	+16
		+36	+36	+36	+12	+12	0	0	0	0	0	0	0	0	0	-18	-25	-38
120 – 180	+68	+83	+106	+39	+54	+18	+25	+40	+63	+100	+160	+250	+400	+630	+4	+12	+20	
	+43	+43	+43	+14	+14	0	0	0	0	0	0	0	0	0	-21	-28	-43	
180 – 250	+79	+96	+122	+44	+61	+20	+29	+46	+72	+115	+185	+290	+460	+720	+5	+13	+22	
	+50	+50	+50	+15	+15	0	0	0	0	0	0	0	0	0	-24	-33	-50	
250 – 315	+88	+108	+137	+49	+69	+23	+32	+52	+81	+130	+210	+320	+520	+810	+5	+16	+25	
	+56	+56	+56	+17	+17	0	0	0	0	0	0	0	0	0	-27	-36	-56	
315 – 400	+98	+119	+151	+54	+75	+25	+36	+57	+89	+140	+230	+360	+570	+890	+7	+17	+28	
	+62	+62	+62	+18	+18	0	0	0	0	0	0	0	0	0	-29	-40	-61	
400 – 500	+108	+131	+165	+60	+83	+27	+40	+63	+97	+155	+250	+400	+630	+970	+8	+18	+29	
	+68	+68	+68	+20	+20	0	0	0	0	0	0	0	0	0	-32	-45	-68	

Dimensions for "JS" and "js" are identical – for values see Tables 2 and 2.1

TOLERANCES FOR EXTERNAL DIMENSIONS (SHAFTS)



**Table 5.2 – Extract from DIN 7160, allowances in µm (0.001 mm)**

Symbol	e6	e7	e8	f6	f7	f8	g5	g6	g7	h4	h5	h6	h7	h8	h9	h10	h11	js6
<b>From / to</b>																		
<b>3</b>	-14	-14	-14	-6	-6	-6	-2	-2	-2	0	0	0	0	0	0	0	0	+3
	-20	-24	-28	-12	-16	-20	-6	-8	-12	-3	-4	-6	-10	-14	-25	-40	-60	-3
<b>3 – 6</b>	-20	-20	-20	-10	-10	-10	-4	-4	-4	0	0	0	0	0	0	0	0	+4
	-28	-32	-38	-18	-22	-28	-9	-12	-16	-4	-5	-8	-12	-18	-30	-48	-78	-4
<b>6 – 10</b>	-25	-25	-25	-13	-13	-13	-5	-5	-5	0	0	0	0	0	0	0	0	+4.5
	-34	-40	-47	-27	-28	-35	-11	-14	-20	-4	-6	-9	-15	-22	-36	-58	-90	-4.5
<b>10 – 18</b>	-32	-32	-32	-16	-16	-16	-6	-6	-6	0	0	0	0	0	0	0	0	+5.5
	-43	-50	-59	-27	-34	-43	-14	-17	-24	-5	-8	-11	-18	-27	-43	-70	-110	-5.5
<b>18 – 30</b>	-40	-40	-40	-20	-20	-20	-7	-7	-7	0	0	0	0	0	0	0	0	+6.5
	-53	-61	-73	-33	-41	-53	-16	-20	-28	-6	-9	-13	-21	-33	-52	-84	-130	-6.5
<b>30 – 50</b>	-50	-50	-50	-25	-25	-25	-9	-9	-9	0	0	0	0	0	0	0	0	+8
	-66	-75	-89	-41	-50	-64	-20	-25	-34	-7	-11	-16	-25	-39	-62	-100	-160	+8
<b>50 – 80</b>	-60	-60	-60	-30	-30	-30	-10	-10	-10	0	0	0	0	0	0	0	0	+9.5
	-79	-90	-106	-49	-60	-76	-23	-29	-40	-8	-13	-19	-30	-46	-74	-120	-190	-9.5
<b>80 – 120</b>	-72	-72	-72	-36	-36	-36	-12	-12	-12	0	0	0	0	0	0	0	0	+11
	-94	-107	-126	-58	-71	-90	-27	-34	-47	-10	-15	-22	-35	-54	-87	-140	-220	-11
<b>120 – 180</b>	-85	-85	-85	-43	-43	-43	-14	-14	-14	0	0	0	0	0	0	0	0	+12.5
	-110	-125	-148	-68	-83	-106	-32	-39	-54	-12	-18	-25	-40	-63	-100	-160	-250	-12.5
<b>180 – 250</b>	-100	-100	-100	-50	-50	-50	-15	-15	-15	0	0	0	0	0	0	0	0	+14.5
	-129	-146	-172	-79	-96	-122	-35	-44	-61	-14	-20	-29	-46	-72	-115	-185	-290	-14.5
<b>250 – 315</b>	-110	-110	-110	-56	-56	-56	-17	-17	-17	0	0	0	0	0	0	0	0	+16
	-142	-162	-191	-88	-108	-137	-40	-49	-69	-16	-23	-32	-52	-81	-130	-210	-320	-16
<b>315 – 400</b>	-125	-125	-125	-62	-62	-62	-18	-18	-18	0	0	0	0	0	0	0	0	+18
	-161	-182	-214	-98	-119	-151	-43	-54	-75	-18	-25	-36	-57	-89	-140	-230	-360	-18
<b>400 – 500</b>	-135	-135	-135	-68	-68	-68	-20	-20	-20	0	0	0	0	0	0	0	0	+20
	-175	-198	-232	-108	-131	-165	-47	-60	-83	-20	-27	-40	-63	-97	-155	-250	-400	-20

**Table 5.3**

Symbol	js7	js8	js9	js10	js11	js12	js13	js14	js15	js16	js17	js18	k6	k7	k8	m5	m6	m7
<b>From / to</b>																		
<b>3</b>	+5	+7	+12.5	+20	+30	+50	+70	+125	+200	+300	-	-	+6	+10	+14	+6	+8	-
	-5	-7	-12.5	-20	-30	-50	-70	-125	-200	-300	-	-	0	0	0	+2	+2	-
<b>3 – 6</b>	+6	+9	+15	+24	+37.5	+60	+90	+150	+240	+375	-	-	+9	+13	+18	+9	+12	+16
	-6	-9	-15	-24	-37.5	-60	-90	-150	-240	-375	-	-	-1	-1	-1	+4	+4	+4
<b>6 – 10</b>	+7.5	+11	+18	+29	+45	+75	+110	+180	+290	+450	+750	-	+10	+16	+22	+12	+15	+21
	-7.5	-11	-18	-29	-45	-75	-110	-180	-290	-450	-750	-	+1	+1	0	+6	+16	+6
<b>10 – 18</b>	+9	+13.5	+21.5	+35	+55	+90	+135	+215	+350	+550	+900	+1350	+12	+19	+27	+12	+18	+25
	-9	-13.5	-21.5	-35	-55	-90	-135	-215	-350	-550	-900	-1350	+1	+1	0	+7	+7	+7
<b>18 – 30</b>	+10.5	+16.5	+26	+42	+65	+105	+165	+260	+420	+650	+1050	+1650	+15	+23	+33	+17	+21	+29
	-10.5	-16.5	-26	-42	-65	-105	-165	-260	-420	-650	-1050	-1650	+2	+2	0	+8	+8	+8
<b>30 – 50</b>	+12.5	+19.5	+31	+50	+80	+125	+195	+310	+500	+800	+1250	+1950	+18	+27	+39	+20	+25	+34
	-12.5	-19.5	-31	-50	-80	-125	-195	-310	-500	-800	-1250	-1950	+2	+2	0	+9	+9	+9
<b>50 – 80</b>	+15	+23	+37	+60	+95	+150	+230	+370	+600	+950	+1500	+2300	+21	+32	+46	+24	+30	+41
	-15	-23	-37	-60	-95	-150	-230	-370	-600	-950	-1500	-2300	+2	+2	0	+11	-11	+11
<b>80 – 120</b>	+17.5	+27	+43.5	+70	+110	+175	+270	+435	+700	+1100	+1750	+2700	+25	+38	+54	+28	+35	+48
	-17.5	-27	-43.5	-70	-110	-175	-270	-435	-700	-1100	-1750	-2700	+3	+3	0	+13	+13	+13
<b>120 – 180</b>	+20	+31.5	+50	+80	+125	+200	+315	+500	+800	+1250	+2000	+3150	+28	+43	+63	+33	+40	+55
	-20	-31.5	-50	-80	-125	-200	-315	-500	-800	-1250	-2000	-3150	+3	+3	0	+15	+15	+15
<b>180 – 250</b>	+23	+36	+57.5	+92.5	+145	+230	+360	+575	+925	+1450	+2300	+3600	+33	+50	+72	+37	+46	+63
	-23	-36	-57.5	-92.5	-145	-230	-360	-575	-925	-1450	-2300	-3600	+4	+4	0	+17	+17	+17
<b>250 – 315</b>	+26	+40.5	+65	+105	+160	+260	+405	+650	+1050	+1600	+2600	+4500	+36	+56	+81	+43	+52	+72
	-26	-40.5	-65	-105	-160	-260	-405	-650	-1050	-1600	-2600	-4500	+4	+4	0	+20	+20	+20
<b>315 – 400</b>	+28.5	+44.5	+70	+115	+180	+285	+445	+700	+1150	+1800	+2850	+4450	+40	+61	+89	+46	+57	+78
	-28.8	-44.8	-70	-115	-180	-285	-445	-700	-1150	-1800	-2850	-4450	+4	+4	0	+21	+21	+21
<b>400 – 500</b>	+31.5	+48.5	+77.5	+125	+200	+315	+485	+775	+1250	+2000	+3150	+4850	+45	+68	+97	+50	+63	+86
	-31.5	-48.5	-77.5	-125	-200	-315	-485	-775	-1250	-2000	-3150	-4850	+5	+5	0	+23	+23	+23

## 6. SURFACE QUALITY PARAMETERS FOR SEAL HOUSINGS

General requirements for seal housings.

Surface	Roughness Rt	Roughness Ra	Material ratio Mr
Counter surface	≤ 3 μm	0.05 ≥ optimum value 0.2 ≤ 0.3 μm	50 % < optimum value 80 % ≤ 90 %
Groove bottom	≤ 10 μm	≤ 1.8 μm	
Groove sides	≤ 16 μm	≤ 3 μm	

## 7. ABBREVIATIONS USED FOR MATERIALS IN HF SEALS

Material	Abbreviations	Tolerance
NBR Shore A 65	N65	± 5 Shore
NBR Shore A 70	N70	± 5 Shore
NBR Shore A 80	N80	± 5 Shore
NBR Shore A 90	N90	± 5 Shore
FPM Shore A 75	V75	± 5 Shore
FPM Shore A 80	V80	± 5 Shore
FPM Shore A 90	V90	± 5 Shore
EPDM Shore A70 sulphur crosslinked	E70S	± 5 Shore
EPDM Shore A70 peroxide crosslinked	E70P	± 5 Shore
MVQ Shore 40	S40	± 5 Shore
MVQ Shore 70	S70	± 5 Shore
FEP/MVQ	F-S	
FFKM Shore A 80	K80	± 5 Shore
NBR cotton fabric	NBR-C	
FPM cotton fabric	FPM-C	
FPM aramid fabric	FPM-K	
Phenol resin/fabric	PH/GEW	
Graphite/serrated perforated plate	GRSP	
Graphite/smooth plate	GRGL	
Klinger graphite Topgraph	TGR	
Klinger C4400	C4400	
PTFE/pure	PT	
PTFE/glass	PT/GL	
PTFE/bronze	PTBR	
PTFE/glass/MOS2	PT/GM	
PTFE/carbon	PT/K	
Soft iron	WE	
Stainless steel 1.4571	INOX	
Polyurethane	PUR	
Polyurethane, hydrolysis-resistant	H-PU	
Polyamide	PA	
Polyoxymethylene	POM	
Ultra high density polyethylene	UHMW-PE	

## 8. BUSHES

### 8.1 GENERAL

#### Technical data

To make things clearer, we would like to define in advance some important technical data used repeatedly in this document. For this purpose, we shall consider a bush with an internal diameter "d" and a width "L".

$$\text{Specific bearing load} = p \text{ (N/mm}^2\text{)}$$

For a vertically applied load "F" (N):

$$p = \frac{F}{d \cdot L}$$

$$\text{Sliding speed} = v \text{ (m/s)}$$

In the case of rotation: for a rotation speed "n" (min<sup>-1</sup>):

$$v = \frac{d \cdot \pi \cdot n}{60 \cdot 10^3}$$

In the case of oscillatory motion: where "n" is the frequency of the oscillatory motion (min<sup>-1</sup>) and "μ" is the amplitude of the motion expressed in degrees:

$$v = \frac{d \cdot \pi}{60 \cdot 10^3} \cdot \frac{2\mu \cdot n}{360}$$

$$pv \text{ value} = p \times v \text{ (N/mm}^2 \times \text{m/s)}$$

#### Calculation of the service life

The service life of a bush depends on the specific bearing load, sliding speed, operating temperature and the shaft material (surface quality and hardness). On request, we can calculate a service life for you, but this can be no more than a guide.

#### Installing the bushes

Use the basic arrangement shown in Figure 8.1 to install bushes with an external diameter of up to 50 mm. By machining the bearing surface at a specific height h, the bush can be pressed an exact depth h into the hole.

Use an auxiliary ring as shown in Figure 8.2 to fit bushes with an external diameter greater than 50 mm. On request, we can calculate the press-in force FE for you.

#### Installation principle

We recommend protecting the bushes against dirt by using type SWP seal ends or shaft seal rings (Fig. 8.3). Finally, chamfers should preferably be machined in order to prevent stress concentrations at the edges of the bushes (Fig. 8.4), or the bushes should project above the surrounding material (Fig. 8.5).

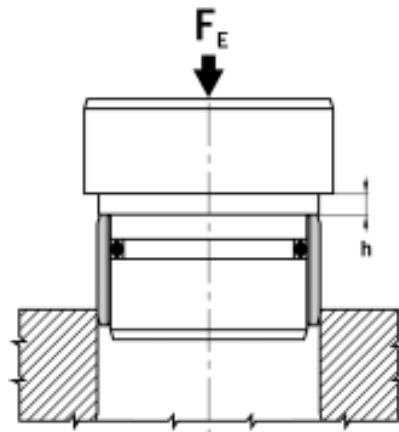

Figure 8.1:

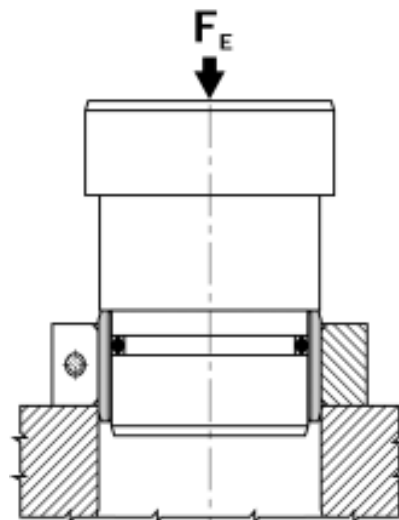

Figure 8.2:

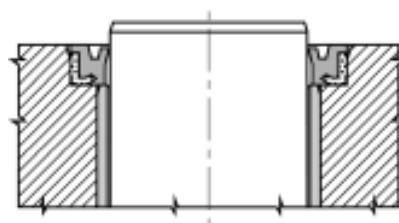

Figure 8.3:

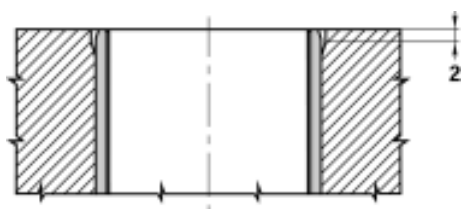

Figure 8.4:

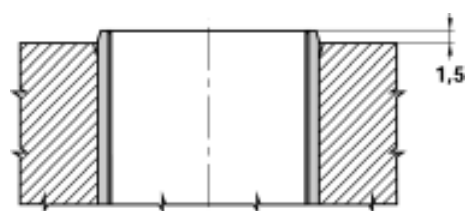
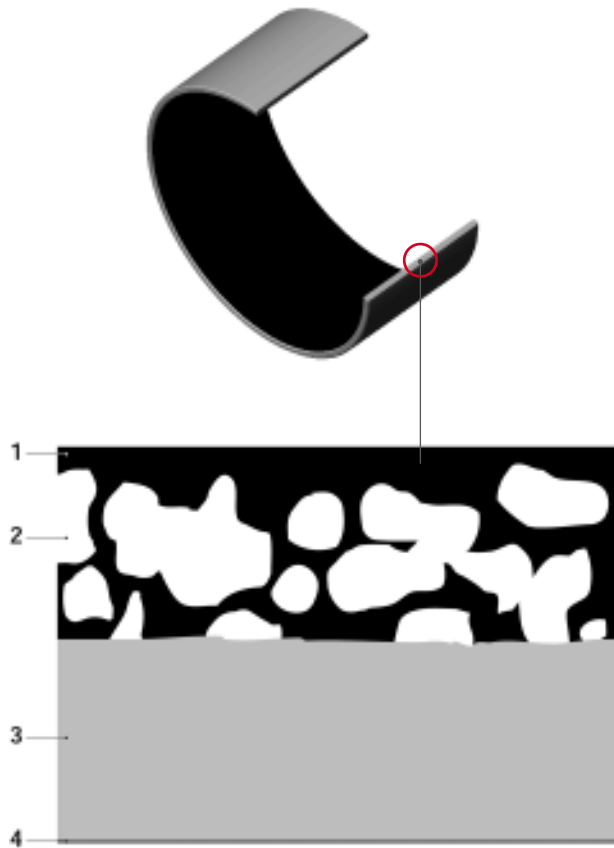

Figure 8.5:

## 8.2 MAINTENANCE-FREE BUSHES TYPE BK-1



Coefficient of friction	p N/mm <sup>2</sup>	v m/s
0.025	250-140	<0.001
0.04-0.07	140-60	0.001-0.005
0.07-0.1	60-10	0.005-0.05
0.1-0.15	10-1	0.05-0.5
0.15-0.2	<1	0.5-2

- 1 = PTFE-lead mixture: 0.01 - 0.05 mm
- 2 = Bronze coating: 0.20 - 0.35 mm
- 3 = Steel backing
- 4 = Surface protection: ~0.002 mm

### Construction

The BK-1 bush consists of a porous bronze coating (2) sinter-fused onto a steel backing (3). A PTFE-lead mixture (1) is then rolled into the bronze coating. The steel backing is protected against corrosion by external tin- or copper-plating (4).

### Properties

The BK-1 bush has many advantages:

- Suitable for dry running and maintenance-free
- Noise and frequency absorption
- Hydrodynamic operation possible
- High permissible load
- Good chemical resistance
- Good friction characteristics
- No stick-slip
- Wide temperature range
- High slide speed
- No water absorption
- Low play during operation
- Extremely space-saving

### Areas of application

BK-1 bushes are suitable for translatory, rotary and oscillatory motions.

### Application examples:

- Rod guide for pneumatic and hydraulic cylinders
- Attachment eyes for pneumatic and hydraulic cylinders
- Conveyor-belt systems, textile machinery, automobiles ...

### 8.3 MAINTENANCE-FREE BUSHES TYPE BK-2

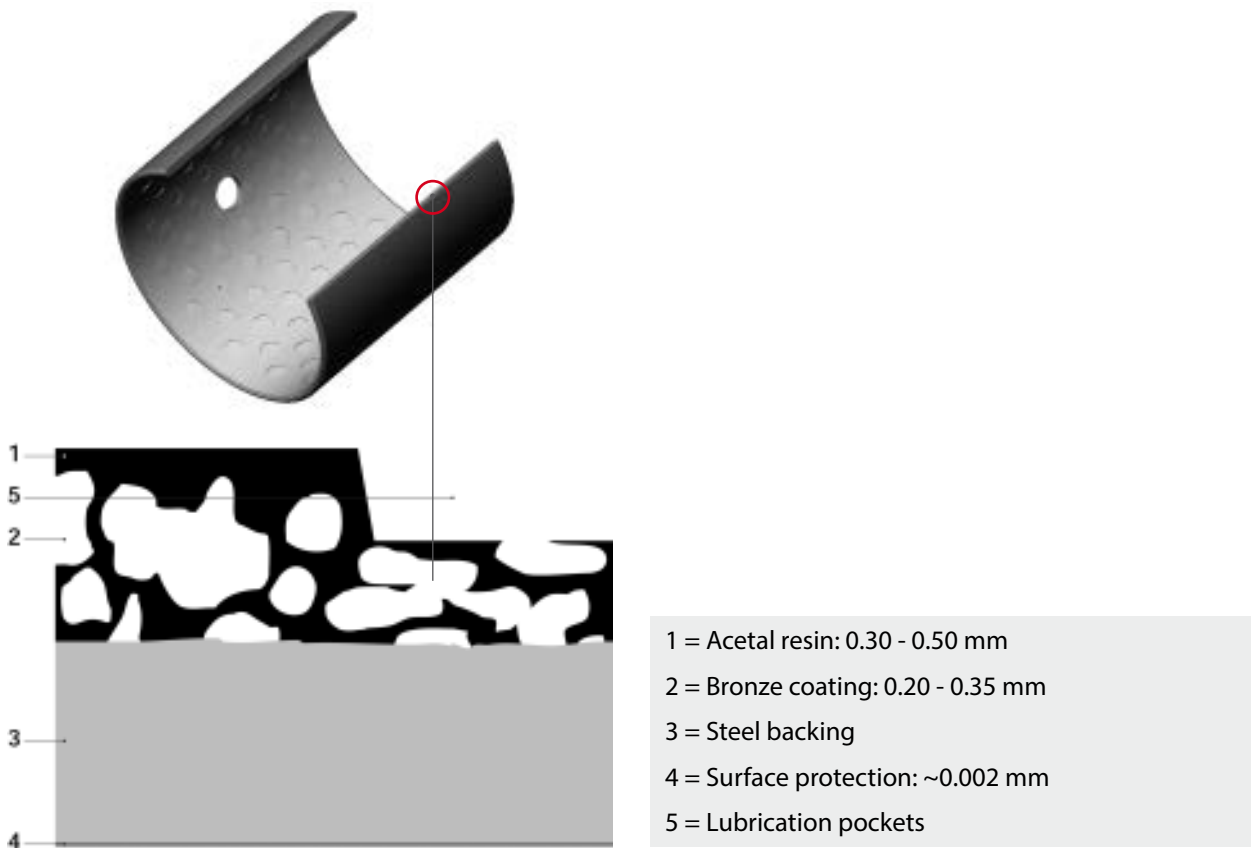

#### Construction

The BK-2 bush consists of a porous bronze coating (2) sinter-fused onto a steel backing (3). An acetal resin POM (1) is then rolled into the bronze coating. The steel backing is protected against corrosion by external tin- or copper-plating (4). Finally the lubrication pockets (5) are stamped into the slide coating.

#### Properties

The BK-2 bush has many advantages:

- Maintenance-free operation
- Noise and frequency absorption
- Relubricatable
- Hydrodynamic operation possible
- High permissible load
- Good friction characteristics
- High slide speed
- No water absorption
- Can be used where oil film formation is difficult
- Low play during operation
- Extremely space-saving

#### Areas of application

BK-2 bushes are suitable for rotary and oscillatory motions. Initial lubrication with grease is advisable, and continual lubrication substantially lengthens the service life of the slide bearing.

#### Application examples:

- Attachment eyes for pneumatic and hydraulic cylinders
- Agricultural equipment
- Material handling equipment
- Construction machinery, ...

## 8.4 BRONZE BUSHES TYPE BK090

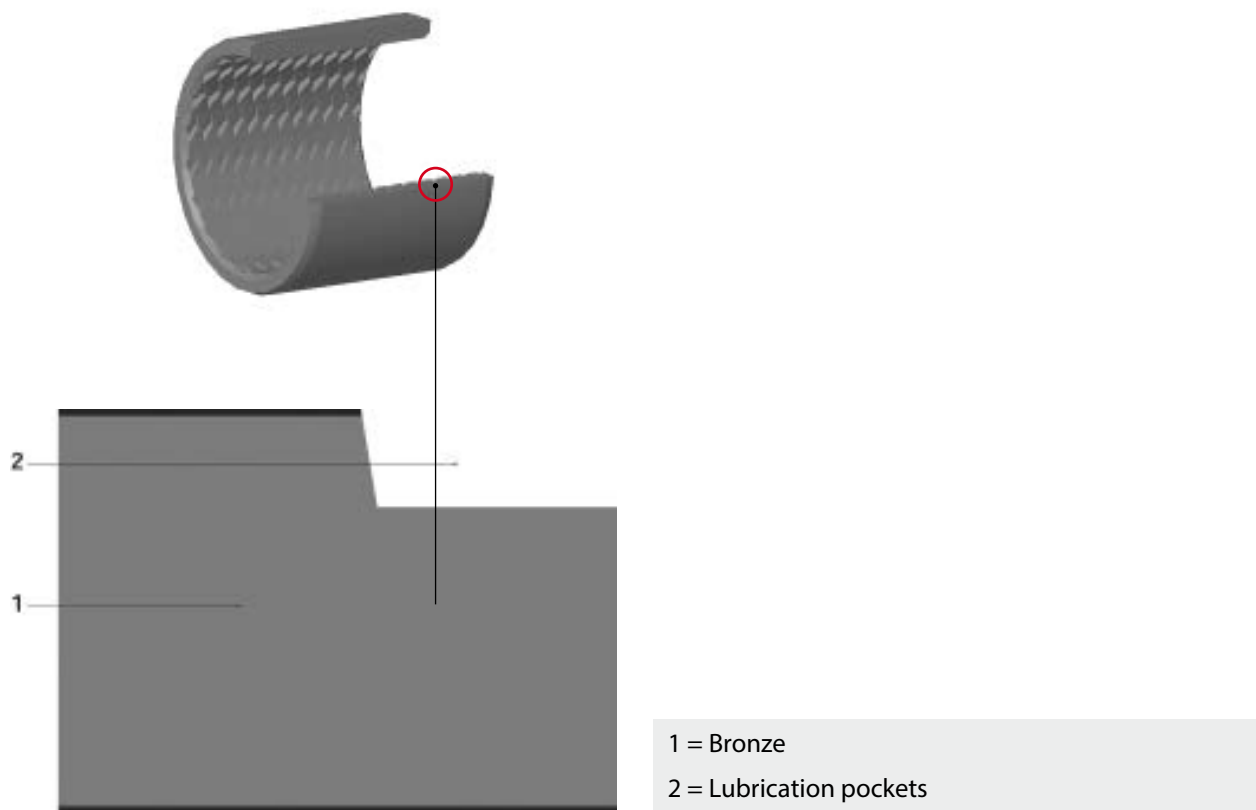

### Construction

The BK090 bush is made entirely out of CuSn8 bronze and manufactured from calibrated rolled strips. The entire sliding surface is covered with diamond-shaped lubrication pockets. Lubricant is introduced into these pockets, which then function as reservoirs, releasing the lubricant progressively during operation. Drill holes to allow relubrication.

### Properties

The BK090 bush has many advantages:

- Maintenance-free operation
- Relubricatable
- Suitable for dirty conditions
- Shock and vibration resistant
- High permissible load
- Good friction characteristics
- No water absorption
- Low play during operation
- Extremely space-saving

### Areas of application

BK090 bushes are suitable for rotary and oscillatory motions. Initial lubrication with grease is advisable, and continual lubrication substantially lengthens the service life of the slide bearing.

### Application examples:

- Attachment eyes for hydraulic cylinders
- Forestry machinery
- Agricultural equipment
- Conveyors and elevators
- Construction machinery, ...

## 9. O-RINGS

### 9.1 DESCRIPTION OF O-RINGS

O-rings are ring-shaped seals with a round cross-section (a torus) defined by the inside diameter ( $D$ ) and the cross-sectional diameter ( $d$ ). It is the most common seal type for hydraulic and pneumatic applications.

#### O-rings have the following advantages:

- The groove is simple and easy to machine
- Large choice of compounds: NBR, FPM, EPDM, silicone, PTFE, PUR, ...
- Easy to install due to its symmetry
- Attractive price thanks to new production techniques
- Extremely wide variety of applications: static, dynamic (both linear and rotary), ...
- Compact design

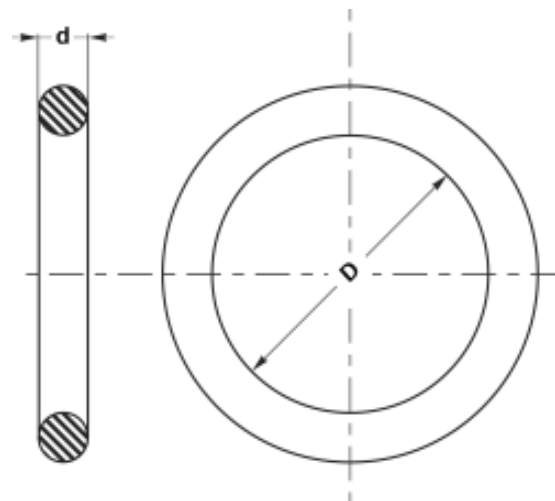

Figure 9.1:

### 9.2 PRINCIPLE OF O-RINGS

The functional principle is summarised in Figure 9.2:

- The O-ring is installed in a groove with a depth  $g$  smaller than the diameter  $d$  of the cross-section (Fig. 9.2).
- After installation, the O-ring seal is squeezed and this creates a pressing action (Fig. 9.3).
- The media exerts pressure on the O-ring and intensifies the initial pressing action (Fig. 9.4).

The initial precompression (Fig. 9.3) is very important! Depending on the application and material, the compression of the elastomer will change as follows:

- From 3 to 20 % dynamic seal (pneumatic and hydraulic). In this catalogue, the initial pressure fluctuates between 12 and 14 % for a dynamic seal
- From 15 to 30 % static seal. In this catalogue, the initial pressure used for a static seal fluctuates between 17 and 27 %.



Figure 9.2:

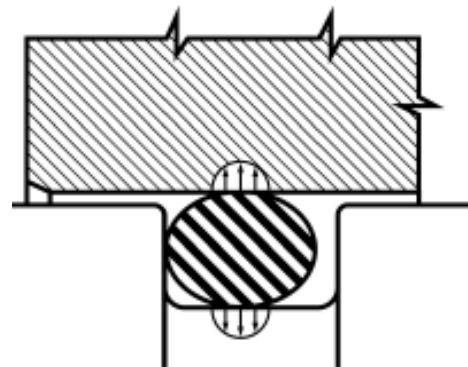

Figure 9.3:

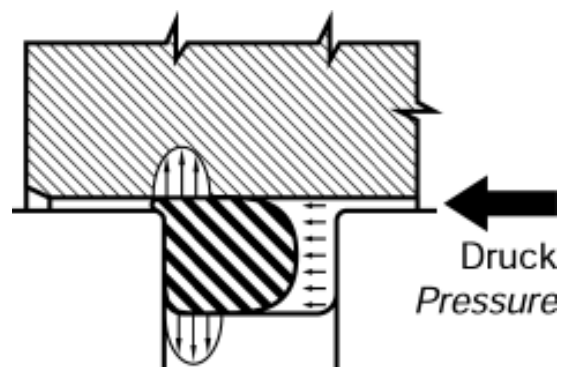

Figure 9.4:



### 9.3 TECHNICAL FEATURES OF O-RINGS

#### Static working pressure

- up to 150 bar for NBR 70 shore A without back-up ring
- up to 500 bar for NBR 70 shore A with back-up ring

#### Linear speed

Up to 0.5 m/s

#### Speed with rotational movements

Up to 2 m/s

#### C.S.: compression set

Compression set is a very important property because it expresses the time-related elasticity of the elastomer used.

Figures 9.5, 9.6 and 9.7 show an O-ring with cross-sectional diameter (d) compressed with a force (F) resulting in a value (C) for a specified time and temperature.

The value R is measured after the specified time has elapsed:

$$\text{C. S. (\%)} = \frac{d - R}{d - C} \cdot 100$$

A completely elastic material has a C.S. of 0 %, while a completely inelastic material has a C.S. of 100 %.

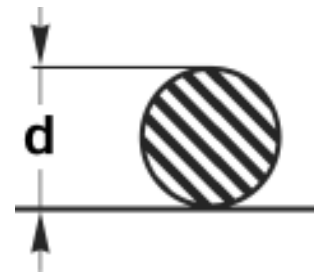

Figure 9.5:

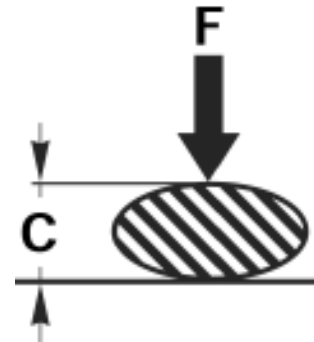

Figure 9.6:



Figure 9.7:

### 9.4 PERMISSIBLE CLEARANCE GAP OF O-RINGS

The highest permissible clearance gap *e* can be determined from the chart in Figure 9.8. The clearance gap must be less than the value shown left of the relevant curve and depends on the pressure used.

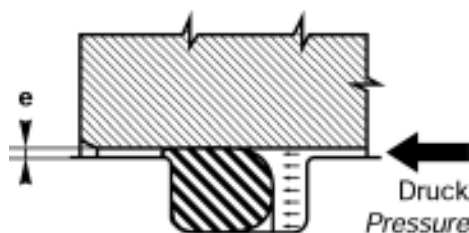

Figure 9.8 b

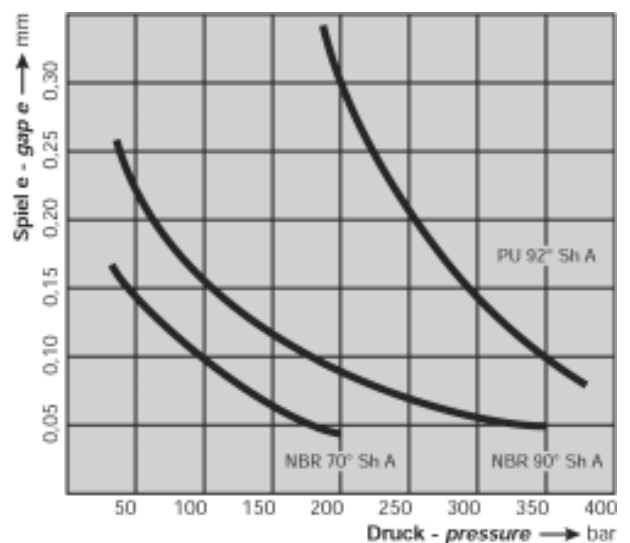

Figure 9.8 a

### 9.5 DIMENSIONAL TOLERANCES FOR O-RINGS IN ACCORDANCE WITH ISO 3601-1:2008 CLASS B

The tolerances for the cord diameters  $d_2$  are shown in Table 9.9.

The tolerances for the internal diameter  $d_1$  are calculated in accordance with ISO 3601-1:2008, Class B using the following formula:

$$d_1 = (d_1^{0.95} \cdot 0.009) + 0.11 \text{ [mm]}$$

This formula is for use only with metric dimensions. The tolerances for internal diameters  $d_1$  up to 600 mm are listed in Table 9.10.

Cord diameter $d_2$ (mm)	Tolerances $\pm$
$d_2 \leq 0.80$	on request
$0.80 < d_2 \leq 2.25$	0.08
$2.25 < d_2 \leq 3.15$	0.09
$3.15 < d_2 \leq 4.50$	0.10
$4.50 < d_2 \leq 6.30$	0.13
$6.30 < d_2 \leq 8.40$	0.15
$8.40 < d_2 \leq 10.00$	0.21
$10.00 < d_2 \leq 12.00$	0.25
$d_2 \leq 12.00$	on request

Internal diameter $d_1$ (mm)	Tolerances $\pm$
$d_1 \leq 1.71$	0.12
$1.71 < d_1 \leq 2.93$	0.13
$2.93 < d_1 \leq 4.17$	0.14
$4.17 < d_1 \leq 5.44$	0.15
$5.44 < d_1 \leq 6.72$	0.16
$6.72 < d_1 \leq 8.01$	0.17
$8.01 < d_1 \leq 9.31$	0.18
$9.31 < d_1 \leq 10.62$	0.19
$10.62 < d_1 \leq 11.94$	0.20
$11.94 < d_1 \leq 13.27$	0.21
$13.27 < d_1 \leq 14.61$	0.22
$14.61 < d_1 \leq 15.95$	0.23
$15.95 < d_1 \leq 17.29$	0.24
$17.29 < d_1 \leq 18.64$	0.25
$18.64 < d_1 \leq 20.00$	0.26
$20.00 < d_1 \leq 21.36$	0.27
$21.36 < d_1 \leq 22.73$	0.28
$22.73 < d_1 \leq 24.10$	0.29
$24.10 < d_1 \leq 25.47$	0.30
$25.47 < d_1 \leq 26.85$	0.31
$26.85 < d_1 \leq 28.23$	0.32
$28.23 < d_1 \leq 29.61$	0.33
$29.61 < d_1 \leq 31.00$	0.34
$31.00 < d_1 \leq 32.39$	0.35
$32.39 < d_1 \leq 33.78$	0.36
$33.78 < d_1 \leq 35.18$	0.37
$35.18 < d_1 \leq 36.58$	0.38
$36.58 < d_1 \leq 37.98$	0.39
$37.98 < d_1 \leq 39.38$	0.40
$39.38 < d_1 \leq 40.79$	0.41
$40.79 < d_1 \leq 42.20$	0.42
$42.20 < d_1 \leq 43.61$	0.43
$43.61 < d_1 \leq 45.02$	0.44
$45.02 < d_1 \leq 46.44$	0.45
$46.44 < d_1 \leq 47.86$	0.46
$47.86 < d_1 \leq 49.28$	0.47
$49.28 < d_1 \leq 50.70$	0.48
$50.70 < d_1 \leq 52.12$	0.49
$52.12 < d_1 \leq 53.55$	0.50
$53.55 < d_1 \leq 54.98$	0.51
$54.98 < d_1 \leq 56.41$	0.52
$56.41 < d_1 \leq 57.84$	0.53
$57.84 < d_1 \leq 59.27$	0.54
$59.27 < d_1 \leq 60.71$	0.55
$60.71 < d_1 \leq 62.14$	0.56
$62.14 < d_1 \leq 63.58$	0.57

Internal diameter $d_1$ (mm)	Tolerances $\pm$
$63.58 < d_1 \leq 65.02$	0.58
$65.02 < d_1 \leq 66.47$	0.59
$66.47 < d_1 \leq 67.91$	0.60
$67.91 < d_1 \leq 69.35$	0.61
$69.35 < d_1 \leq 70.80$	0.62
$70.80 < d_1 \leq 72.25$	0.63
$72.25 < d_1 \leq 73.70$	0.64
$73.70 < d_1 \leq 75.15$	0.65
$75.15 < d_1 \leq 76.60$	0.66
$76.60 < d_1 \leq 78.05$	0.67
$78.05 < d_1 \leq 79.51$	0.68
$79.51 < d_1 \leq 80.97$	0.69
$80.97 < d_1 \leq 82.42$	0.70
$82.42 < d_1 \leq 83.88$	0.71
$83.88 < d_1 \leq 85.34$	0.72
$85.34 < d_1 \leq 86.80$	0.73
$86.80 < d_1 \leq 88.27$	0.74
$88.27 < d_1 \leq 89.73$	0.75
$89.73 < d_1 \leq 91.20$	0.76
$91.20 < d_1 \leq 92.66$	0.77
$92.66 < d_1 \leq 94.13$	0.78
$94.13 < d_1 \leq 95.60$	0.79
$95.60 < d_1 \leq 97.07$	0.80
$97.07 < d_1 \leq 98.54$	0.81
$98.54 < d_1 \leq 100.01$	0.82
$100.01 < d_1 \leq 101.48$	0.83
$101.48 < d_1 \leq 102.96$	0.84
$102.96 < d_1 \leq 104.43$	0.85
$104.43 < d_1 \leq 105.91$	0.86
$105.91 < d_1 \leq 107.39$	0.87
$107.39 < d_1 \leq 108.86$	0.88
$108.86 < d_1 \leq 110.34$	0.89
$110.34 < d_1 \leq 111.82$	0.90
$111.82 < d_1 \leq 113.30$	0.91
$113.30 < d_1 \leq 114.79$	0.92
$114.79 < d_1 \leq 116.27$	0.93
$116.27 < d_1 \leq 117.75$	0.94
$117.75 < d_1 \leq 119.24$	0.95
$119.24 < d_1 \leq 120.72$	0.96
$120.72 < d_1 \leq 122.21$	0.97
$122.21 < d_1 \leq 123.70$	0.98
$123.70 < d_1 \leq 125.19$	0.99
$125.19 < d_1 \leq 126.68$	1.00
$126.68 < d_1 \leq 128.17$	1.01
$128.17 < d_1 \leq 129.66$	1.02
$129.66 < d_1 \leq 131.15$	1.03

Table 9.10	
Internal diameter $d_1$ (mm)	Tolerances $\pm$
131.15 < $d_1$ ≤ 132.64	1.04
132.64 < $d_1$ ≤ 134.14	1.05
134.14 < $d_1$ ≤ 135.63	1.06
135.63 < $d_1$ ≤ 137.13	1.07
137.13 < $d_1$ ≤ 138.62	1.08
138.62 < $d_1$ ≤ 140.12	1.09
140.12 < $d_1$ ≤ 141.62	1.10
141.62 < $d_1$ ≤ 143.12	1.11
143.12 < $d_1$ ≤ 144.62	1.12
144.62 < $d_1$ ≤ 146.12	1.13
146.12 < $d_1$ ≤ 147.62	1.14
147.62 < $d_1$ ≤ 149.12	1.15
149.12 < $d_1$ ≤ 150.62	1.16
150.62 < $d_1$ ≤ 152.13	1.17
152.13 < $d_1$ ≤ 153.63	1.18
153.63 < $d_1$ ≤ 155.13	1.19
155.13 < $d_1$ ≤ 156.64	1.20
156.64 < $d_1$ ≤ 158.15	1.21
158.15 < $d_1$ ≤ 159.65	1.22
159.65 < $d_1$ ≤ 161.16	1.23
161.16 < $d_1$ ≤ 162.67	1.24
162.67 < $d_1$ ≤ 164.18	1.25
164.18 < $d_1$ ≤ 165.69	1.26
165.69 < $d_1$ ≤ 167.20	1.27
167.20 < $d_1$ ≤ 168.71	1.28
168.71 < $d_1$ ≤ 170.22	1.29
170.22 < $d_1$ ≤ 171.73	1.30
171.73 < $d_1$ ≤ 173.25	1.31
173.25 < $d_1$ ≤ 174.76	1.32
174.76 < $d_1$ ≤ 176.28	1.33
176.28 < $d_1$ ≤ 177.79	1.34
177.79 < $d_1$ ≤ 179.31	1.35
179.31 < $d_1$ ≤ 180.82	1.36
180.82 < $d_1$ ≤ 182.34	1.37
182.34 < $d_1$ ≤ 183.86	1.38
183.86 < $d_1$ ≤ 185.38	1.39
185.38 < $d_1$ ≤ 186.89	1.40
186.89 < $d_1$ ≤ 188.41	1.41
188.41 < $d_1$ ≤ 189.93	1.42
189.93 < $d_1$ ≤ 191.45	1.43
191.45 < $d_1$ ≤ 192.98	1.44
192.98 < $d_1$ ≤ 194.50	1.45
194.50 < $d_1$ ≤ 196.02	1.46
196.02 < $d_1$ ≤ 197.54	1.47
197.54 < $d_1$ ≤ 199.07	1.48
199.07 < $d_1$ ≤ 200.59	1.49
200.59 < $d_1$ ≤ 202.12	1.50
202.12 < $d_1$ ≤ 203.64	1.51
203.64 < $d_1$ ≤ 205.17	1.52
205.17 < $d_1$ ≤ 206.69	1.53
206.69 < $d_1$ ≤ 208.22	1.54
208.22 < $d_1$ ≤ 209.75	1.55
209.75 < $d_1$ ≤ 211.28	1.56
211.28 < $d_1$ ≤ 212.81	1.57
212.81 < $d_1$ ≤ 214.34	1.58
214.34 < $d_1$ ≤ 215.87	1.59
215.87 < $d_1$ ≤ 217.40	1.60
217.40 < $d_1$ ≤ 218.93	1.61
218.93 < $d_1$ ≤ 220.46	1.62
220.46 < $d_1$ ≤ 221.99	1.63
221.99 < $d_1$ ≤ 223.52	1.64
223.52 < $d_1$ ≤ 225.06	1.65

Table 9.10	
Internal diameter $d_1$ (mm)	Tolerances $\pm$
225.06 < $d_1$ ≤ 226.59	1.66
226.59 < $d_1$ ≤ 228.12	1.67
228.12 < $d_1$ ≤ 229.66	1.68
229.66 < $d_1$ ≤ 231.19	1.69
231.19 < $d_1$ ≤ 232.73	1.70
232.73 < $d_1$ ≤ 234.27	1.71
234.27 < $d_1$ ≤ 235.80	1.72
235.80 < $d_1$ ≤ 237.34	1.73
237.34 < $d_1$ ≤ 238.88	1.74
238.88 < $d_1$ ≤ 240.42	1.75
240.42 < $d_1$ ≤ 241.95	1.76
241.95 < $d_1$ ≤ 243.49	1.77
243.49 < $d_1$ ≤ 245.03	1.78
245.03 < $d_1$ ≤ 246.57	1.79
246.57 < $d_1$ ≤ 248.11	1.80
248.11 < $d_1$ ≤ 249.66	1.81
249.66 < $d_1$ ≤ 251.20	1.82
251.20 < $d_1$ ≤ 252.74	1.83
252.74 < $d_1$ ≤ 254.28	1.84
254.28 < $d_1$ ≤ 255.82	1.85
255.82 < $d_1$ ≤ 257.37	1.86
257.37 < $d_1$ ≤ 258.91	1.87
258.91 < $d_1$ ≤ 260.46	1.88
260.46 < $d_1$ ≤ 262.00	1.89
262.00 < $d_1$ ≤ 263.55	1.90
263.55 < $d_1$ ≤ 265.09	1.91
265.09 < $d_1$ ≤ 266.64	1.92
266.64 < $d_1$ ≤ 268.18	1.93
268.18 < $d_1$ ≤ 269.73	1.94
269.73 < $d_1$ ≤ 271.28	1.95
271.28 < $d_1$ ≤ 272.83	1.96
272.83 < $d_1$ ≤ 274.38	1.97
274.38 < $d_1$ ≤ 275.92	1.98
275.92 < $d_1$ ≤ 277.47	1.99
277.47 < $d_1$ ≤ 279.02	2.00
279.02 < $d_1$ ≤ 280.57	2.01
280.57 < $d_1$ ≤ 282.12	2.02
282.12 < $d_1$ ≤ 283.68	2.03
283.68 < $d_1$ ≤ 285.23	2.04
285.23 < $d_1$ ≤ 286.78	2.05
286.78 < $d_1$ ≤ 288.33	2.06
288.33 < $d_1$ ≤ 289.88	2.07
289.88 < $d_1$ ≤ 291.44	2.08
291.44 < $d_1$ ≤ 292.99	2.09
292.99 < $d_1$ ≤ 294.54	2.10
294.54 < $d_1$ ≤ 296.10	2.11
296.10 < $d_1$ ≤ 297.65	2.12
297.65 < $d_1$ ≤ 299.21	2.13
299.21 < $d_1$ ≤ 300.76	2.14
300.76 < $d_1$ ≤ 302.32	2.15
302.32 < $d_1$ ≤ 303.88	2.16
303.88 < $d_1$ ≤ 305.43	2.17
305.43 < $d_1$ ≤ 306.99	2.18
306.99 < $d_1$ ≤ 308.55	2.19
308.55 < $d_1$ ≤ 310.11	2.20
310.11 < $d_1$ ≤ 311.66	2.21
311.66 < $d_1$ ≤ 313.22	2.22
313.22 < $d_1$ ≤ 314.78	2.23
314.78 < $d_1$ ≤ 316.34	2.24
316.34 < $d_1$ ≤ 317.90	2.25
317.90 < $d_1$ ≤ 319.46	2.26
319.46 < $d_1$ ≤ 321.02	2.27



T

**Table 9.10**

Internal diameter $d_1$ (mm)	Tolerances $\pm$
321.02 < $d_1$ ≤ 322.58	2.28
322.58 < $d_1$ ≤ 324.15	2.29
324.15 < $d_1$ ≤ 325.71	2.30
325.71 < $d_1$ ≤ 327.27	2.31
327.27 < $d_1$ ≤ 328.83	2.32
328.83 < $d_1$ ≤ 330.39	2.33
330.39 < $d_1$ ≤ 331.96	2.34
331.96 < $d_1$ ≤ 333.52	2.35
333.52 < $d_1$ ≤ 335.09	2.36
335.09 < $d_1$ ≤ 336.65	2.37
336.65 < $d_1$ ≤ 338.21	2.38
338.21 < $d_1$ ≤ 339.78	2.39
339.78 < $d_1$ ≤ 341.35	2.40
341.35 < $d_1$ ≤ 342.91	2.41
342.91 < $d_1$ ≤ 344.48	2.42
344.48 < $d_1$ ≤ 346.04	2.43
346.04 < $d_1$ ≤ 347.61	2.44
347.61 < $d_1$ ≤ 349.18	2.45
349.18 < $d_1$ ≤ 350.75	2.46
350.75 < $d_1$ ≤ 352.31	2.47
352.31 < $d_1$ ≤ 353.88	2.48
353.88 < $d_1$ ≤ 355.45	2.49
355.45 < $d_1$ ≤ 357.02	2.50
357.02 < $d_1$ ≤ 358.59	2.51
358.59 < $d_1$ ≤ 360.16	2.52
360.16 < $d_1$ ≤ 361.73	2.53
361.73 < $d_1$ ≤ 363.30	2.54
363.30 < $d_1$ ≤ 364.87	2.55
364.87 < $d_1$ ≤ 366.44	2.56
366.44 < $d_1$ ≤ 368.01	2.57
368.01 < $d_1$ ≤ 369.58	2.58
369.58 < $d_1$ ≤ 371.16	2.59
371.16 < $d_1$ ≤ 372.73	2.60
372.73 < $d_1$ ≤ 374.30	2.61
374.30 < $d_1$ ≤ 375.87	2.62
375.87 < $d_1$ ≤ 377.45	2.63
377.45 < $d_1$ ≤ 379.02	2.64
379.02 < $d_1$ ≤ 380.59	2.65
380.59 < $d_1$ ≤ 382.17	2.66
382.17 < $d_1$ ≤ 383.74	2.67
383.74 < $d_1$ ≤ 385.32	2.68
385.32 < $d_1$ ≤ 386.89	2.69
386.89 < $d_1$ ≤ 388.47	2.70
388.47 < $d_1$ ≤ 390.05	2.71
390.05 < $d_1$ ≤ 391.62	2.72
391.62 < $d_1$ ≤ 393.20	2.73
393.20 < $d_1$ ≤ 394.78	2.74
394.78 < $d_1$ ≤ 396.35	2.75
396.35 < $d_1$ ≤ 397.93	2.76
397.93 < $d_1$ ≤ 399.51	2.77
399.51 < $d_1$ ≤ 401.09	2.78
401.09 < $d_1$ ≤ 402.66	2.79
402.66 < $d_1$ ≤ 404.24	2.80
404.24 < $d_1$ ≤ 405.82	2.81
405.82 < $d_1$ ≤ 407.40	2.82
407.40 < $d_1$ ≤ 408.98	2.83
408.98 < $d_1$ ≤ 410.56	2.84
410.56 < $d_1$ ≤ 412.14	2.85
412.14 < $d_1$ ≤ 413.72	2.86
413.72 < $d_1$ ≤ 415.30	2.87
415.30 < $d_1$ ≤ 416.89	2.88
416.89 < $d_1$ ≤ 418.47	2.89

**Table 9.10**

Internal diameter $d_1$ (mm)	Tolerances $\pm$
418.47 < $d_1$ ≤ 420.05	2.90
420.05 < $d_1$ ≤ 421.63	2.91
421.63 < $d_1$ ≤ 423.21	2.92
423.21 < $d_1$ ≤ 424.80	2.93
424.80 < $d_1$ ≤ 426.38	2.94
426.38 < $d_1$ ≤ 427.96	2.95
427.96 < $d_1$ ≤ 429.55	2.96
429.55 < $d_1$ ≤ 431.13	2.97
431.13 < $d_1$ ≤ 432.71	2.98
432.71 < $d_1$ ≤ 434.30	2.99
434.30 < $d_1$ ≤ 435.88	3.00
435.88 < $d_1$ ≤ 437.47	3.01
437.47 < $d_1$ ≤ 439.05	3.02
439.05 < $d_1$ ≤ 440.64	3.03
440.64 < $d_1$ ≤ 442.22	3.04
442.22 < $d_1$ ≤ 443.81	3.05
443.81 < $d_1$ ≤ 445.40	3.06
445.40 < $d_1$ ≤ 446.98	3.07
446.98 < $d_1$ ≤ 448.57	3.08
448.57 < $d_1$ ≤ 450.16	3.09
450.16 < $d_1$ ≤ 451.75	3.10
451.75 < $d_1$ ≤ 453.33	3.11
453.33 < $d_1$ ≤ 454.92	3.12
454.92 < $d_1$ ≤ 456.51	3.13
456.51 < $d_1$ ≤ 458.10	3.14
458.10 < $d_1$ ≤ 459.69	3.15
459.69 < $d_1$ ≤ 461.28	3.16
461.28 < $d_1$ ≤ 462.87	3.17
462.87 < $d_1$ ≤ 464.46	3.18
464.46 < $d_1$ ≤ 466.05	3.19
466.05 < $d_1$ ≤ 467.64	3.20
467.64 < $d_1$ ≤ 469.23	3.21
469.23 < $d_1$ ≤ 470.82	3.22
470.82 < $d_1$ ≤ 472.41	3.23
472.41 < $d_1$ ≤ 474.00	3.24
474.00 < $d_1$ ≤ 475.59	3.25
475.59 < $d_1$ ≤ 477.19	3.26
477.19 < $d_1$ ≤ 478.78	3.27
478.78 < $d_1$ ≤ 480.37	3.28
480.37 < $d_1$ ≤ 481.96	3.29
481.96 < $d_1$ ≤ 483.56	3.30
483.56 < $d_1$ ≤ 485.15	3.31
485.15 < $d_1$ ≤ 486.74	3.32
486.74 < $d_1$ ≤ 488.34	3.33
488.34 < $d_1$ ≤ 489.93	3.34
489.93 < $d_1$ ≤ 491.52	3.35
491.52 < $d_1$ ≤ 493.12	3.36
493.12 < $d_1$ ≤ 494.71	3.37
494.71 < $d_1$ ≤ 496.31	3.38
496.31 < $d_1$ ≤ 497.90	3.39
497.90 < $d_1$ ≤ 499.50	3.40
499.50 < $d_1$ ≤ 501.10	3.41
501.10 < $d_1$ ≤ 502.69	3.42
502.69 < $d_1$ ≤ 504.29	3.43
504.29 < $d_1$ ≤ 505.89	3.44
505.89 < $d_1$ ≤ 507.48	3.45
507.48 < $d_1$ ≤ 509.08	3.46
509.08 < $d_1$ ≤ 510.68	3.47
510.68 < $d_1$ ≤ 512.27	3.48
512.27 < $d_1$ ≤ 513.87	3.49
513.87 < $d_1$ ≤ 515.47	3.50
515.47 < $d_1$ ≤ 517.07	3.51



**Table 9.10**

Internal diameter $d_1$ (mm)	Tolerances $\pm$
517.07 < $d_1$ ≤ 518.67	3.52
518.67 < $d_1$ ≤ 520.27	3.53
520.27 < $d_1$ ≤ 521.87	3.54
521.87 < $d_1$ ≤ 523.46	3.55
523.46 < $d_1$ ≤ 525.06	3.56
525.06 < $d_1$ ≤ 526.66	3.57
526.66 < $d_1$ ≤ 528.26	3.58
528.26 < $d_1$ ≤ 529.86	3.59
529.86 < $d_1$ ≤ 531.46	3.60
531.46 < $d_1$ ≤ 533.07	3.61
533.07 < $d_1$ ≤ 534.67	3.62
534.67 < $d_1$ ≤ 536.27	3.63
536.27 < $d_1$ ≤ 537.87	3.64
537.87 < $d_1$ ≤ 539.47	3.65
539.47 < $d_1$ ≤ 541.07	3.66
541.07 < $d_1$ ≤ 542.68	3.67
542.68 < $d_1$ ≤ 544.28	3.68
544.28 < $d_1$ ≤ 545.88	3.69
545.88 < $d_1$ ≤ 547.48	3.70
547.48 < $d_1$ ≤ 549.09	3.71
549.09 < $d_1$ ≤ 550.69	3.72
550.69 < $d_1$ ≤ 552.29	3.73
552.29 < $d_1$ ≤ 553.90	3.74
553.90 < $d_1$ ≤ 555.50	3.75
555.50 < $d_1$ ≤ 557.11	3.76
557.11 < $d_1$ ≤ 558.71	3.77
558.71 < $d_1$ ≤ 560.32	3.78
560.32 < $d_1$ ≤ 561.92	3.79
561.92 < $d_1$ ≤ 563.53	3.80
563.53 < $d_1$ ≤ 565.13	3.81
565.13 < $d_1$ ≤ 566.74	3.82
566.74 < $d_1$ ≤ 568.34	3.83
568.34 < $d_1$ ≤ 569.95	3.84
569.95 < $d_1$ ≤ 571.56	3.85
571.56 < $d_1$ ≤ 573.16	3.86
573.16 < $d_1$ ≤ 574.77	3.87
574.77 < $d_1$ ≤ 576.38	3.88
576.38 < $d_1$ ≤ 577.98	3.89
577.98 < $d_1$ ≤ 579.59	3.90
579.59 < $d_1$ ≤ 581.20	3.91
581.20 < $d_1$ ≤ 582.81	3.92
582.81 < $d_1$ ≤ 584.42	3.93
584.42 < $d_1$ ≤ 586.02	3.94
586.02 < $d_1$ ≤ 587.63	3.95
587.63 < $d_1$ ≤ 589.24	3.96
589.24 < $d_1$ ≤ 590.85	3.97
590.85 < $d_1$ ≤ 592.46	3.98
592.46 < $d_1$ ≤ 594.07	3.99
594.07 < $d_1$ ≤ 595.68	4.00
595.68 < $d_1$ ≤ 597.29	4.01
597.29 < $d_1$ ≤ 598.90	4.02
598.90 < $d_1$ ≤ 600.00	4.03
$d_1 > 600$	using a formula

9.6 STATIC SEAL OF O-RINGS

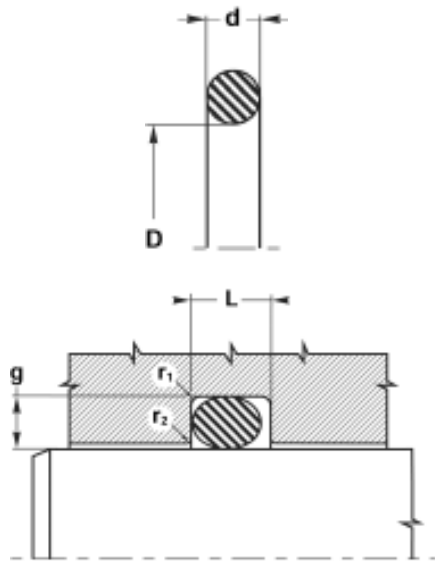

Radial pressing action

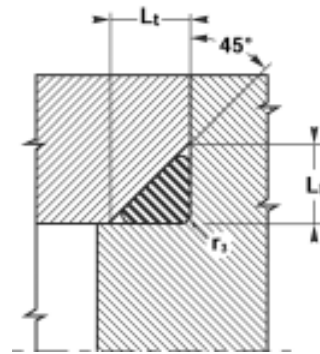

Three-sided pressing action

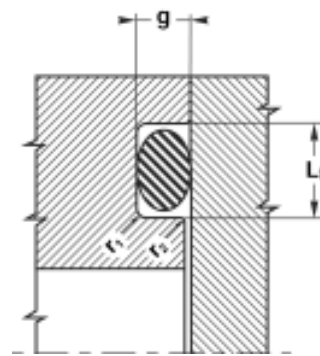
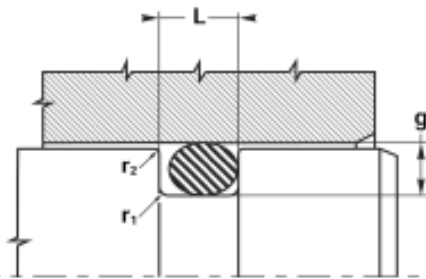

Axial pressing action

Table 9.11

Calculation of grooves and static seal in accordance with DIN 3771/Part 5 (ISO standard in bold)

d O-ring	g 0 / +0.0	L 0 / +0.20	Lf 0 / +0.20	Lt	tol. Lt	r1	r2	r3	
1.00	1.02	0.70	1.40	1.40	1.35	0 / +0.10	0.20	0.10	0.20
1.50	1.52	1.10	2.00	2.10	2.00	0 / +0.10	0.20	0.10	0.20
1.60	1.63	1.20	2.10	2.20	2.15	0 / +0.10	0.30	0.10	0.30
<b>1.78</b>	<b>1.80</b>	<b>1.30</b>	<b>2.40</b>	<b>2.60</b>	<b>2.40</b>	<b>0 / +0.10</b>	<b>0.40</b>	<b>0.10</b>	<b>0.30</b>
1.90		1.40	2.60	2.70	2.55	0 / +0.10	0.40	0.10	0.40
2.00	1.98	1.50	2.70	2.80	2.70	0 / +0.10	0.40	0.10	0.40
2.40		1.80	3.20	3.30	3.20	0 / +0.15	0.50	0.10	0.40
2.50		1.85	3.30	3.40	3.40	0 / +0.15	0.50	0.10	0.60
<b>2.62</b>	<b>2.65</b>	<b>2.00</b>	<b>3.60</b>	<b>3.80</b>	<b>3.50</b>	<b>0 / +0.15</b>	<b>0.60</b>	<b>0.10</b>	<b>0.60</b>
2.70		2.05	3.60	3.80	3.65	0 / +0.15	0.60	0.10	0.60
3.00		2.30	4.00	4.00	4.00	0 / +0.20	0.60	0.15	0.60
3.10		2.40	4.10	4.10	4.10	0 / +0.20	0.60	0.15	0.60
3.50		2.65	4.60	4.70	4.70	0 / +0.20	0.60	0.15	0.90
<b>3.53</b>	<b>3.55</b>	<b>2.70</b>	<b>4.80</b>	<b>5.00</b>	<b>4.80</b>	<b>0 / +0.20</b>	<b>0.80</b>	<b>0.15</b>	<b>0.90</b>
3.60		2.80	4.80	5.10	4.90	0 / +0.20	0.80	0.15	0.90
4.00		3.10	5.20	5.30	5.40	0 / +0.20	0.80	0.15	1.20
4.50		3.50	5.80	5.90	6.10	0 / +0.20	0.80	0.15	1.20
5.00		4.00	6.60	6.70	6.70	0 / +0.25	0.80	0.15	1.20
<b>5.34</b>	<b>5.30</b>	<b>4.30</b>	<b>7.10</b>	<b>7.30</b>	<b>7.10</b>	<b>0 / +0.25</b>	<b>1.20</b>	<b>0.20</b>	<b>1.50</b>
5.50		4.50	7.10	7.30	7.40	0 / +0.25	1.20	0.20	1.50
5.70		4.60	7.20	7.40	7.60	0 / +0.25	1.20	0.20	1.50
6.00		4.90	7.40	7.60	8.00	0 / +0.30	1.20	0.20	1.50
<b>7.00</b>	<b>6.99</b>	<b>5.80</b>	<b>9.50</b>	<b>9.70</b>	<b>9.40</b>	<b>0 / +0.30</b>	<b>1.50</b>	<b>0.20</b>	<b>2.00</b>
8.00		6.70	9.80	10.00	10.80	0 / +0.30	1.50	0.20	2.00
8.40		7.10	10.00	10.30	11.30	0 / +0.30	1.50	0.20	2.00

### 9.7 DYNAMIC SEAL FOR PNEUMATIC CYLINDERS

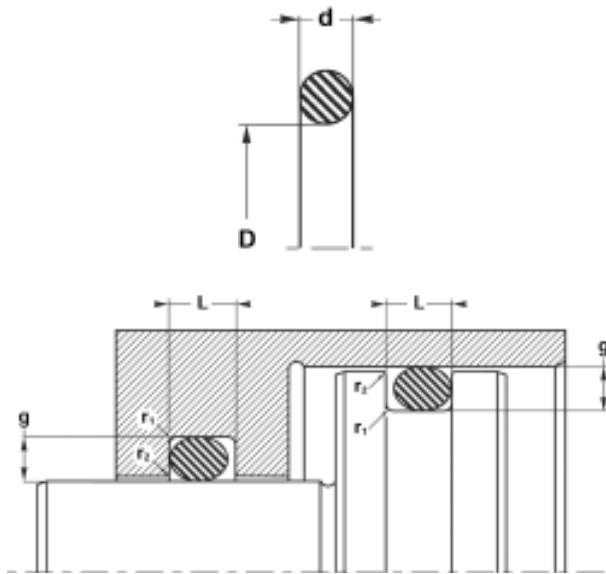

We recommend that the surface finishes, chamfers and radii shown are observed (see 9.9 Installation instructions for O-rings).

**Table 9.12 (ISO standard in bold)**

d	g	L	r1	r2
1.00	1.02	0.95	1.30	0.20
1.50	1.52	1.35	1.90	0.20
1.60	1.63	1.45	2.00	0.30
<b>1.78</b>	<b>1.80</b>	<b>1.55</b>	<b>2.30</b>	<b>0.30</b>
1.90		1.75	2.40	0.40
2.00	1.98	1.80	2.50	0.40
2.40		2.15	2.90	0.50
2.50		2.25	3.00	0.50
<b>2.62</b>	<b>2.65</b>	<b>2.35</b>	<b>3.10</b>	<b>0.60</b>
2.70		2.45	3.30	0.60
3.00		2.75	3.60	0.60
3.10		2.85	3.70	0.60
3.50		3.25	4.20	0.60
<b>3.53</b>	<b>3.55</b>	<b>3.25</b>	<b>4.20</b>	<b>0.80</b>
3.60		3.35	4.30	0.80
4.00		3.70	4.80	0.80
4.50		4.20	5.40	0.80
5.00		4.65	6.00	0.80
<b>5.34</b>	<b>5.30</b>	<b>4.95</b>	<b>6.40</b>	<b>1.20</b>
5.50		5.15	6.60	1.20
5.70		5.35	6.90	1.20
6.00		5.65	7.20	1.20
<b>7.00</b>	<b>6.99</b>	<b>6.60</b>	<b>8.40</b>	<b>1.50</b>
8.00		7.60	9.60	1.50
8.40		7.90	10.10	1.50

### 9.8 DYNAMIC SEAL FOR HYDRAULIC CYLINDERS

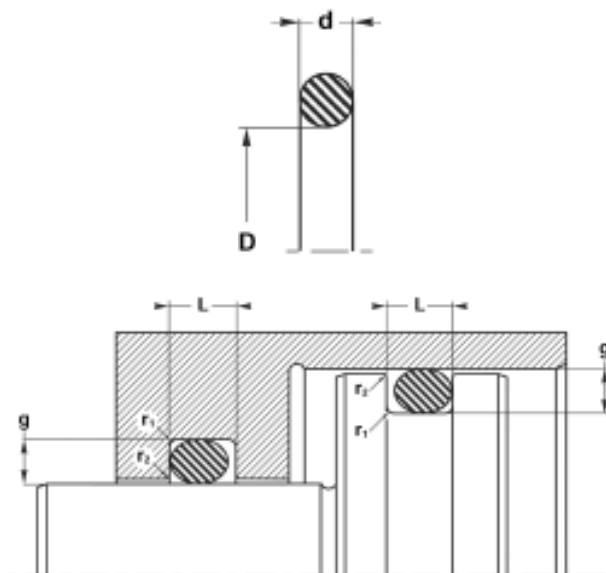

We recommend that the surface finishes, chamfers and radii shown are observed (see 9.9 Installation instructions for O-rings).

**Table 9.13 (ISO standard in bold)**

d	g	L	r1	r2
1.00	1.02	0.90	1.40	0.20
1.50	1.52	1.25	2.00	0.20
1.60	1.63	1.30	2.10	0.30
<b>1.78</b>	<b>1.80</b>	<b>1.55</b>	<b>2.40</b>	<b>0.40</b>
1.90		1.55	2.60	0.40
2.00	1.98	1.65	2.70	0.40
2.40		2.05	3.20	0.50
2.50		2.15	3.30	0.50
<b>2.62</b>	<b>2.65</b>	<b>2.25</b>	<b>3.60</b>	<b>0.60</b>
2.70		2.30	3.60	0.60
3.00		2.60	4.00	0.60
3.10		2.70	4.10	0.60
3.50		3.05	4.60	0.60
<b>3.53</b>	<b>3.55</b>	<b>3.10</b>	<b>4.80</b>	<b>0.80</b>
3.60		3.15	4.80	0.80
4.00		3.50	5.20	0.80
4.50		4.00	5.80	0.80
5.00		4.40	6.60	0.80
<b>5.34</b>	<b>5.30</b>	<b>4.70</b>	<b>7.10</b>	<b>1.20</b>
5.50		4.80	7.10	1.20
5.70		5.00	7.20	1.20
6.00		5.30	7.40	1.20
<b>7.00</b>	<b>6.99</b>	<b>6.10</b>	<b>9.50</b>	<b>1.50</b>
8.00		7.10	9.80	1.50
8.40		7.50	10.00	1.50

### 9.9 INSTALLATION INSTRUCTIONS FOR O-RINGS

#### Installation and clearance gap

We give advice on the tolerances H7 / f6 for installation. The highest permissible clearance gap  $e$  can be determined from the chart in Figure 9.8 and 9.4 "Permissible clearance gap of O-rings". The clearance gap  $e$  must be less than the value read from axis to the left of the used of the relevant curve and depends on the pressure used.

#### Surface quality

The roughness values stated in table 9.15 must be observed in both the  $R_a$  and  $R_t$  areas.

#### Chamfers

Table 9.14 lists the chamfer lengths  $K$  to be observed.

#### Roundings

Sharp edges must be avoided. The radii to be observed are shown on the following pages.

#### Radial installation

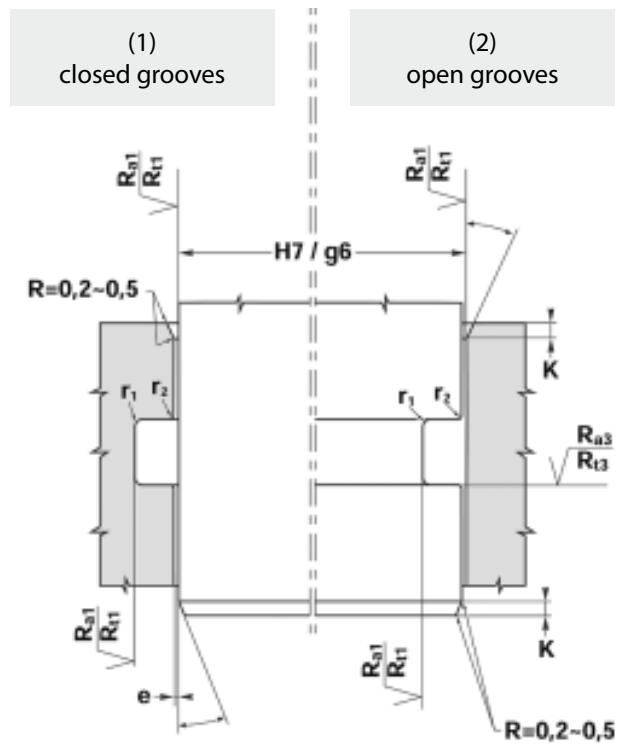

#### Axial installation

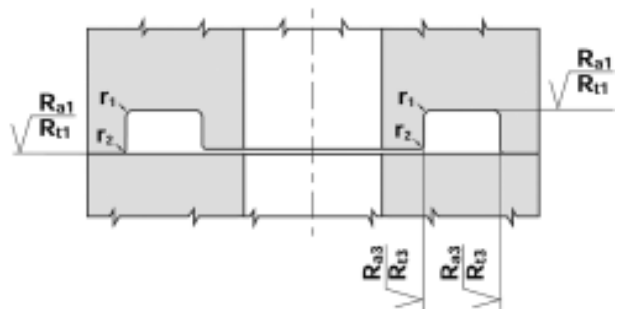

Table 9.14

d O-ring	----- K (mm) -----	
	$\alpha = 20^\circ$	$\alpha = 30^\circ$
$\leq 1.78$	2.0	1.5
$\leq 2.65$	2.5	2.0
$\leq 3.55$	3.0	2.5
$\leq 5.34$	4.0	3.5
$\leq 7.00$	5.0	4.0
$\leq 8.40$	5.5	4.5

Table 9.15

$R_{a1}$	$R_{t1}$	$R_{a3}$	$R_{t3}$
$\leq 0.8 \mu\text{m}$	$\leq 4 \mu\text{m}$	$\leq 3 \mu\text{m}$	$\leq 16 \mu\text{m}$



## 10. BACK-UP RINGS

### 10.1 EXTRUSION

Extrusion problems occur when the **clearance gap  $e$**  between the parts in relation to the pressure deforming the O-ring is too large. The O-ring becomes gradually worn at the edges and wears out completely over time (Fig. 10.1).

The groove is widened by the value  **$E$  (thickness of the back-up ring)**. This back-up ring is installed on the side facing the direction of pressure. This supports the O-ring and solves extrusion problems (Fig. 10.2).

Back-up rings are used similarly for double-acting sealing systems. In this case, two back-up rings are required (Fig. 10.3).

### 10.2 PROFILES AND MATERIALS

We recommend solid back-up rings for internal and external grooves. PTFE must be used in applications with high temperatures and special fluids. For external grooves, the back-up rings have to be cut through to allow installation.

### 10.3 FURTHER INFORMATION

Although a back-up ring is a very simple product, its choice and dimensions can be very complex, as we will demonstrate below.

- A** The problem of **replacing existing parts**: there is an enormous difference in the depth of the grooves used. The initial compression can vary between 10 and 30 % (see page 228).

**Example:** our standard rings BU and PBK. For an O-ring  $d = 2.62$  mm, the section of the ring will be 2.25 mm for the PBK and 2.18 mm for the BU. Therefore the determination of the dimensions of the existing pieces must be done very carefully, because any dimension is possible; **every manufacturer uses different standards**.

Incorrectly determined dimensions can have disastrous consequences. If the ring is a poor fit for the groove, it can cause the following problems:

- If the cross-section of the ring is too large, installation will be difficult, if not impossible and the ring will inevitably wear out (see Fig. 10.4).
- On the other hand, if the cross-section is too small, there is no point in installing it: the extrusion problem is as bad as ever, as can be seen in Figure 10.5.

- B** With respect to the **new versions**, the seal manufacturers' standard ranges are very often limited. The same ring is used for static and dynamic sealing.

**Example:** our PBK rings are often used for static sealing. However, they are more suitable for dynamic applications (see Table 9.13 in "9.8 Dynamic seal for hydraulic cylinders"). PBK rings are used in static applications mainly on the grounds of economy. However this conflicts with the groove depth we recommend in "9.9 Installation instructions for O-rings". For dimensions corresponding to those in Table 9.14, we recommend a DST 108 in H-PU.

Selecting a back-up ring for a new design is completely different to selecting one as a replacement.

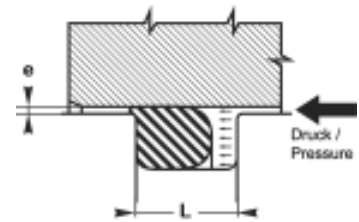

Figure 10.1:

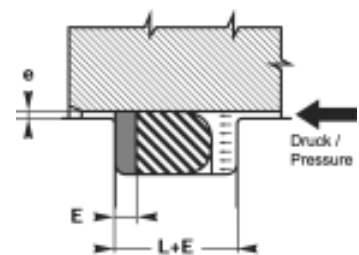

Figure 10.2:

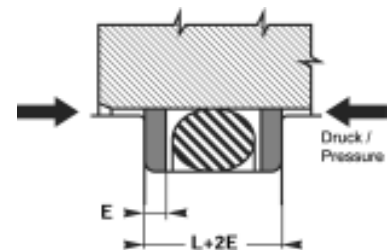

Figure 10.3:

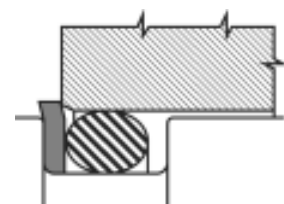

Figure 10.4:

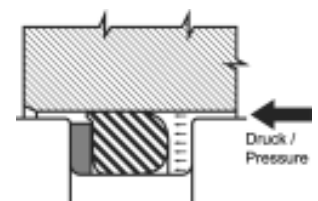
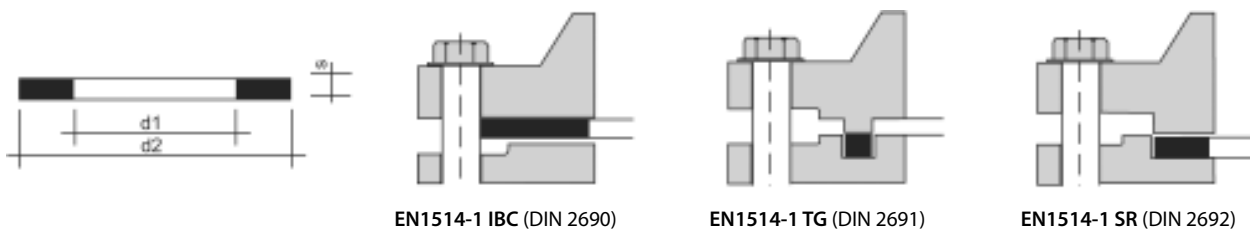

Figure 10.5:

# 11. FLAT SEALS

## 11.1 FLAT SEALS IN ACCORDANCE WITH EN1514-1 (DIN 2690, 2691, 2692)



Standard:		DIN 2690						DIN 2691		DIN 2692	
Flange shape:		A-B smooth seal surface without/with sealing lip						C-D tongue/groove		E-F projection/recess	
Nominal pressure:		PN 2.5	PN 6	PN 10	PN 16	PN 25	PN 40	PN 10-160		PN 10-100	
DN mm	d1 mm	d2 mm	d2 mm	d2 mm	d2 mm	d2 mm	d2 mm	d1 mm	d2 mm	d1 mm	d2 mm
4	6	-	-	-	-	30	-	20	30	-	-
6	10	28	28	38	38	38	38	20	30	-	-
8	14	33	33	43	43	43	43	22	32	-	-
10	18	38	38	45	45	45	45	24	34	18	34
15	22	43	43	50	50	50	50	29	39	22	39
20	28	53	53	60	60	60	60	36	50	28	50
25	35	63	63	70	70	70	70	43	57	35	57
32	43	75	75	82	82	82	82	51	65	43	65
40	49	85	85	92	92	92	92	61	75	49	75
50	61	95	95	107	107	107	107	73	87	61	87
60	-	-	-	-	-	-	-	-	-	-	-
65	77	115	115	127	127	127	127	95	109	77	109
80	90	132	132	142	142	142	142	106	120	90	120
100	115	152	152	162	162	168	168	129	149	115	149
125	141	182	182	192	192	195	195	155	175	141	175
150	169	207	207	218	218	225	225	183	203	169	203
(175)	195	237	237	248	248	255	267	213	233	195	233
200	220	262	262	273	273	285	292	239	259	220	259
250	274	318	318	328	330	342	353	292	312	274	312
300	325	373	373	378	385	402	418	343	363	325	363
350	368	423	423	438	445	458	475	395	421	368	421
400	420	473	473	490	497	515	547	447	473	420	473
(450)	470	528	528	540	557	565	572	-	-	-	-
500	520	578	578	595	618	625	628	549	575	520	575
600	620	680	680	695	735	730	745	649	675	620	675
700	720	785	785	810	805	830	850	751	777	720	777
800	820	890	890	915	910	940	970	856	882	820	882
900	920	990	990	1015	1010	1040	1080	961	987	920	987
1000	1020	1090	1090	1120	1125	1150	1190	1062	1092	1020	1091
1100	-	-	-	-	-	-	-	-	-	-	-
1200	1220	1290	1305	1340	1340	1360	1395	-	-	-	-
1400	1420	1490	1520	1545	1540	1575	1615	-	-	-	-
1500	-	-	-	-	-	-	-	-	-	-	-
1600	1620	1700	1720	1770	1760	1795	1830	-	-	-	-
1800	1820	1900	1930	1970	1960	2000	-	-	-	-	-
2000	2020	2100	2138	2182	2168	2230	-	-	-	-	-
2200	2220	2307	2384	2384	-	-	-	-	-	-	-
2400	2420	2507	2558	2594	-	-	-	-	-	-	-
2600	2620	2707	2762	2794	-	-	-	-	-	-	-
2800	2820	2924	2972	3014	-	-	-	-	-	-	-
3000	3020	3124	3172	3228	-	-	-	-	-	-	-
3200	3220	3324	3382	-	-	-	-	-	-	-	-
3400	3420	3524	3592	-	-	-	-	-	-	-	-
3600	3620	3734	3804	-	-	-	-	-	-	-	-
3800	3820	3931	-	-	-	-	-	-	-	-	-
4000	4020	4131	-	-	-	-	-	-	-	-	-
Flange standard:		DIN 2630	DIN 2631	DIN 2632	DIN 2633	DIN 2634	DIN 2635	DIN 2512	DIN 2512	DIN 2513	DIN 2513

## 11.2 DIMENSIONS AND TOLERANCES FOR SEALING PLATES, CUT PLATES AND PUNCHED ARTICLES

Tolerances for plates, cut plates and punched articles in accordance with DIN 7715 Part 5			
Nominal size	Class P1 Tolerances in mm	Class P2 Tolerances in mm	Class P3 Tolerances in mm
0.0 – 1.6	± 0.20	± 0.20	± 0.40
> 1.6 – 4.0	± 0.20	± 0.30	± 0.40
> 4.0 – 6.3	± 0.20	± 0.40	± 0.50
> 6.3 – 10.0	± 0.30	± 0.50	± 0.60
> 10.0 – 25.0	± 0.30	± 0.60	± 0.80
25.0 – 40.0	± 0.40	± 0.80	± 1.00
40.0 – 63.0	± 0.50	± 1.00	± 1.50
> 63.0 – 100.0	± 0.60	± 1.20	± 2.00
> 100.0 – 160.0	± 0.80	± 1.40	± 2.50
> 160.0 – 250.0	± 1.00	± 1.60	± 3.00
> 250.0 – 400.0	± 1.60	± 2.50	± 5.00
	Tolerances in %	Tolerances in %	Tolerances in %
> 400.0	± 0.50	± 0.80	± 1.50

Abbreviations used for materials in HANSA-FLEX articles	
Material	Abbreviations
Graphite/serrated perforated plate	GRSP
Graphite/smooth plate	GRGL
Klinger graphite Topgraph	TGR
Klinger C4400	C4400
PTFE/pure	PT
PTFE/glass	PT / GL
PTFE/glass/MOS2	PT / GM
PTFE/carbon	PT / K
Soft iron	WE
Stainless steel 1.4571	INOX

## 12 ON-DEMAND SEAL PRODUCTION



### The HANSA-FLEX seal production centre

With two SEAL-MASTER CNC manufacturing facilities we are able to produce precision seals and special turned parts immediately in plastic or aluminium from 5 – 520 mm using computer-assisted manufacturing techniques. We store thousands of seals as datasets in the production centre's computer ready for just-in-time manufacture of seals from 5 – 520 mm directly to order. We offer same-day supply of almost any seal, whether standard or special profile.

### The advantages of seal production

All seals and special turned parts can be produced as custom parts or standard parts in a mass series or individually with the highest level of precision. Our production software has over one hundred pre-programmed standard profiles. Hence, we are capable of adapting to the specific needs of our customers.

Furthermore, we maintain a standard seal stock with over 11,000 different seal types and dimensions ready and waiting for our customers.

## 13. SEAL PROFILES

### SUPPORT RINGS



Profile DST 108



Profile DST 109



Profile DST 110



Profile DST 111



Profile DST 112



Profile DST 113

T

**PISTON SEALS**

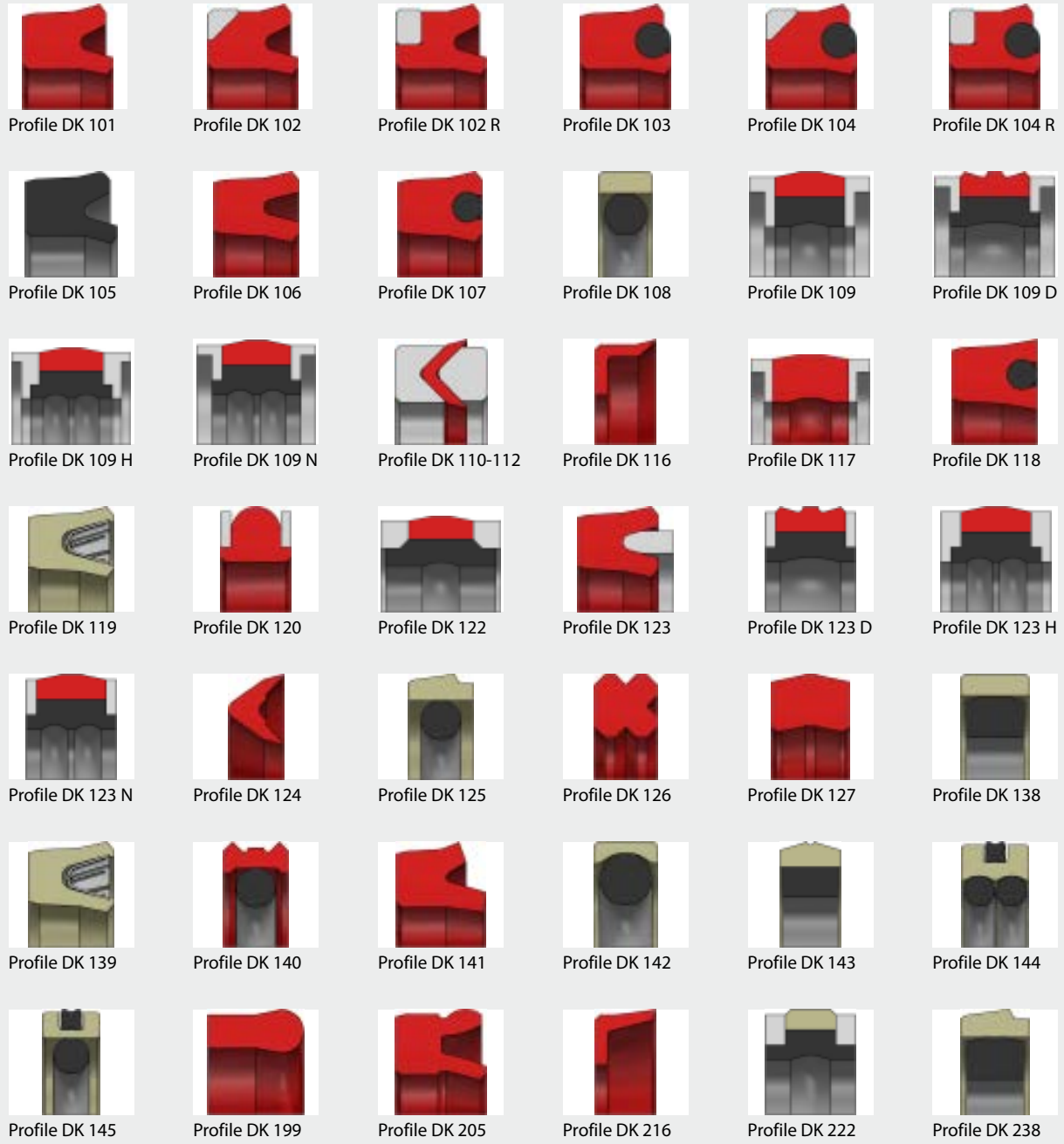

**Important information:** Profiles DK 105 – Pneumatic

**FLAT SEALS**

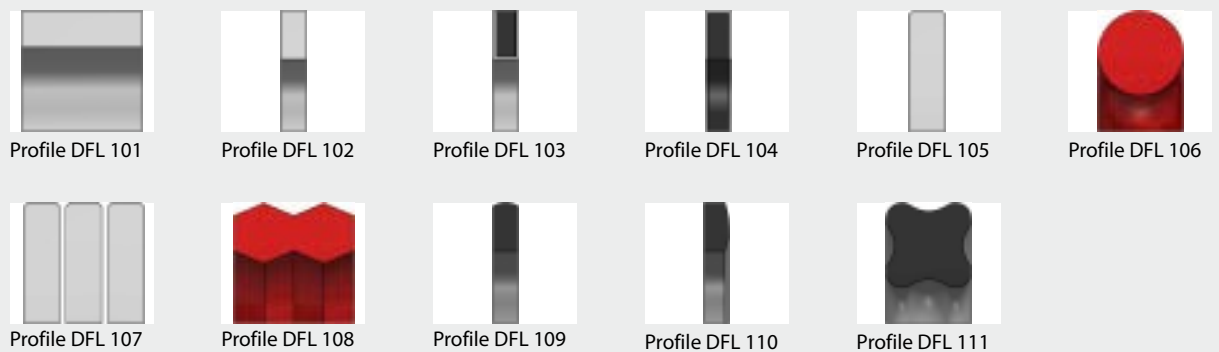

**WIPERS**



Profile DA 101



Profile DA 103



Profile DA 105



Profile DA 107



Profile DA 108



Profile DA 111



Profile DA 112



Profile DA 113



Profile DA 114



Profile DA 115



Profile DA 116



Profile DA 117

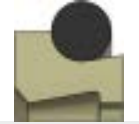

Profile DA 118



Profile DA 211



Profile DA 212



Profile DA 213



Profile DA 102



Profile DA 104



Profile DA 106



Profile DA 119

**Important information:**

Profiles DA 103, DA 106, DA 114 – not snap in wiper  
 Profiles DA 104, DA 105, DA 106 – Pneumatic

**ROTARY SEALS**



Profile DR 101



Profile DR 102



Profile DR 103

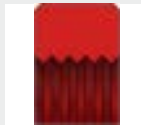

Profile DR 104



Profile DR 105



Profile DR 106



Profile DR 107



Profile DR 108



Profile DR 109



Profile DR 110



Profile DR 111



Profile DR 112



Profile DR 115



Profile DR 116



Profile DR 117



Profile DR 118



Profile DR 119



Profile DR 201



Profile DR 202



Profile DR 203



Profile DR 204



Profile DR 205



Profile DR 206



Profile DR 207



**ROD SEALS**



Profile DS 101



Profile DS 102



Profile DS 102 R

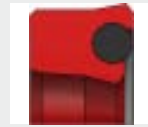

Profile DS 103



Profile DS 104



Profile DS 104 R



Profile DS 105



Profile DS 106



Profile DS 107



Profile DS 108



Profile DS 109



Profile DS 110-112



Profile DS 116



Profile DS 117



Profile DS 117 R



Profile DS 118



Profile DS 119



Profile DS 120

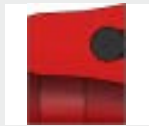

Profile DS 121



Profile DS 124

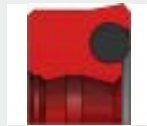

Profile DS 125

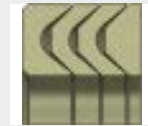

Profile DS 126-128



Profile DS 129

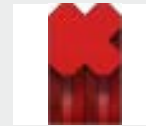

Profile DS 130



Profile DS 131



Profile DS 138

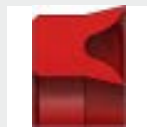

Profile DS 139



Profile DS 141



Profile DS 142



Profile DS 199



Profile DS 205



Profile DS 216



Profile DS 238

**Important information:**  
Profiles DS 105 – Pneumatic

**GUIDE RINGS**



Profile DF 101



Profile DF 102



Profile DF 103



Profile DF104



Profile DF 105



Profile DF 106



Profile DF 107



Profile DF 108



Profile DFB 102

**Should you have special requirements e.g. pressure, temperature, velocity, medium, please contact our sealing technology department. We would be pleased to optimise design and materials to suit your particular application.**

# 14. MATERIAL DATASHEET

Material:			CH-PU	H-PU	H-PU D55	NBR	H-NBR
Colour:			Red	Red	Red	Black	Green
<b>Properties</b>							
Hardness	DIN 53505	Shore A	95	95	97	85	85
Hardness	DIN 53505	Shore D	48	48	55		
Tensile strength	DIN 53504 DIN 53455	N/mm <sup>2</sup>	50	55	55	17	20
Breaking elongation	DIN 53504 DIN 53455	%	450	350	330	150	200
Modulus 100 %	DIN 53504	N/mm <sup>2</sup>	14	16	18	11	10
Modulus 300 %	DIN 53504	N/mm <sup>2</sup>	28	35	39		
Rebound resilience	DIN 53512	%	35	35		20	26
Tear strength	DIN 53507 DIN 53515	N/mm	140	100	100	9	6
Spec. gravity	DIN 53479	g/cm <sup>3</sup>	1.2	1.2	1.22	1.32	1.32
Abrasion	DIN 53516	mm <sup>3</sup>	24	18		130	130
Compression set	DIN 53517	%	27	24	27	6	12
70° / 24 h 20 % Defo.							
Compression set	DIN 53517	%	35	33	35	5	14
100° / 24 h 20 % Defo.							
Compression set	DIN 53517	%					22
150° / 24 h 20 % Defo.							
Compression set	DIN 53517	%					
175° / 24 h 20 % Defo.							
Min. temperature		°C	-35	-25	-20	-35	-20
Max. temperature		°C	110	110	110	120	150
Temp. max water/steam		°C		80	80		120
Temp. max. hot air		°C					180 short
Modulus of elasticity	DIN 53457	N/mm <sup>2</sup>					
Approval for food use							
Special manufacture with approval for food use			x	x			

**ALL MATERIALS AVAILABLE FOR SEAL MANUFACTURE:**

- |                    |               |                    |                    |
|--------------------|---------------|--------------------|--------------------|
| DMH HPU 55D        | DMH SL-PU 96A | DMH H-NBR 90 black | DMH FPM FDA        |
| DMH C-HPU 96A      | DMH PU 93A    | DMH H-NBR ED       | DMH FPM black      |
| DMH C-HPU 57D      | DMH NBR       | DMH EPDM           | DMH FPM ED         |
| DMH C-HPU 72D      | DMH NBR white | DMH EPDM white FDA | DMH Aflas 85       |
| DMH LT-PU 95A      | DMH T-NBR 85  | DMH EPDM KTW / FDA | DMH MVQ 85 blue    |
| DMH LT-PU plus 96A | DMH H-NBR     | DMH FPM            | DMH MVQ nature FDA |





T-NBR	EPDM	VMQ	FPM	PTFE	PTFE	PTFE	POM	PA
Black	Black	Blue	Brown	Virgin White	Glass/MoS2 Grey	Bronze Brown	White	Natural
80	85	85	85	55	63	69	85	85
14	12	7.5	10	27	15	14	70	80
160	80	130	200	350	280	170	40	40
9		6.5	8					
50	37	35	7					
5	9	12	6					
1.28	1.23	1.6	2.51	2.16	2.3	3.2	1.41	1.13
	140		200					
6	5	8	7					
9	7	9	8					
		35	9					
-46	-45	-60	-20	-200	-200	-200	-45	-40
100	150	220	200	260	260	260	100	110
	150	120	150					
	180 short	300 short	300 short					
				540	1320	1375	3000	3000
				x			x	
	x	x	x					
DMH MVQ white FDA		PTFE D05		PTFE II		PTFE E-Carbon		
DMH POM		PTFE TFM		PTFE D46		PTFE Graphite)		
DMH PA		PTFE I		PTFE PEEK				
DMH UHMW-PE		PTFE D05 glass		PTFE Ekonol				
DMH ALU		PTFE D08		PTFE Cond				
PTFE virgin		PTFE 25% glass		PTFE Carbon				

The test results are average results measured from test specimens and cannot be transferred to seal applications. The Seal Technology Department is not liable for products manufactured from our raw material



## Hydraulic seals

<b>Rod seals</b>	
Rod seals B	42
Chevron ring, CH	47
Rod U-ring, DDI, DDIM, DDIM-P	51
U-rings, DUM, DUM-N	53
Rod U-ring, EU, EU-I	55
Rod seals EUS-I	57
Rod seals IBU, IBF	58
Rod packing set, IGR-B, IGRL-B	59
PUR, U-rings	62
Rod U-ring, RS-L, RS-LA	65
Rod packing set, SM, SM-M	67
Rod U-ring, TS, TS AI, TS-L, TS-LA	68

<b>Piston seals</b>	
Piston seals, B-NEO, B-NWO, B-NWO-KR	71
Chevron ring, CH3	73
Sets of groove ring seals type D11W	74
Piston seals, DAS, DBM, DBM-NEO	75
Piston groove rings type DDE, DDEM, DDEM-P	78
Sets of groove ring seals type Typ DPC	80
Sets of groove ring seals type DPS, DPS-SI	81
Sets of groove ring seals type DS, DS-NEO, DS-M	83
Piston seals, DSM	85
U-rings, DUM, DUM-N	86
Sets of groove ring seals type EGR-A	87
Sets of groove ring seals type EUD, EUD-P	88
Sets of groove ring seals type GPK	89
Sets of groove ring seals type GPS	90
U-rings, MU	91
Sets of groove ring seals type PHD, PHD-PU	92
Piston groove rings type RSE, RSE-AE	93
Piston groove rings type RSE-W, RSE-W-AR	94
Complete pistons pneumatics type TDO	96

<b>Wipers</b>	
Wipers type DR	97
Wipers type DSR, DSR-P	98
Wipers type DSR-U, DSR-UP	100
Wipers type GA, GA-FPM	102
Wipers type GA-R	103
Wipers type NW	105
Piston wipers type PPW	106
Wipers type PW-G, PW-U	107
Wipers type SWP, SWP-I	108
Double wiper type UWR, UWR-P	109
Wipers type WAH, WUH	110
Wipers type WRM, WRM-FPM, WRM-H, WRM-P, WRM-PI	111
Wipers type WRS	114
Wipers type WTF-A, WTF-B	115
Wipers type WTFP-B, WTFP-BPU	116

<b>Guide rings</b>	
Guide rings type E-DWR, I-DWR	117
Guide rings type E-GTP, I-GTP	119
Guide rings type E-GTP1, I-GTP1	120
Guide band GT, GTH	122
Pistaon guide rings type WP	124
Pistaon guide rings type WR	125

<b>Bushes</b>	
slide bush type BK-1, BK-1 F, BK-2	126
slide bush type BK 090, BK 090-F	131

## B Dichtung

### Rod seal B

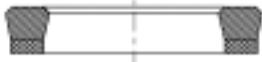

Spaltmaß / Clearance	
Druck / Pressure (bar)	e (mm)
199	< 0,2
299	< 0,1

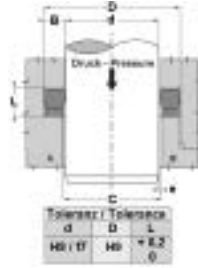

Low-friction seal. Extremely good sealing effect at low pressure. Simple solution.

**Design:** rod seal  
**Operating pressure:** up to 250 bar  
**Sliding speed max.:** 0,5 m/s  
**Temp. min.:** -30 °C  
**Temp. max.:** 110 °C  
**Media:** Mineral oils, Water emulsions  
**Installation:** in closed grooves A, in open grooves B  
**Material:** fabric-reinforced NBR  
**Application:** Hydraulics

**Ordering information:** For special operating conditions (fluid, temperature, pressure ...) please contact us. Alternative material possible: FPM.

Identification	D mm	d mm	L mm	Standard grooves	Identification	D mm	d mm	L mm	Standard grooves
B 055 024	14,00	6,00	6,40		B 236 157	60,00	40,00	14,50	
B 075 047	19,00	12,00	6,40		B 236 188	60,00	48,00	7,00	
B 075 050	19,05	12,70	5,25		B 236 196	60,00	50,00	8,00	ISO 5597
B 086 055	22,00	14,00	6,40	ISO 5597	B 236 196-1	60,00	50,00	10,00	
B 087 050	22,22	12,70	7,65		B 243 175	61,91	44,45	11,60	
B 087 062	22,22	15,87	5,25		B 244 196-1	62,00	50,00	9,50	
B 090 059	23,00	15,00	6,40		B 250 187	63,50	47,62	11,50	
B 093 056	23,81	14,28	7,65		B 250 200-1	63,50	50,80	10,00	
B 094 063-1	24,00	16,00	6,40	ISO 5597	B 255 216-1	65,00	55,00	8,00	
B 094 070	24,00	18,00	5,20		B 262 200	66,67	50,80	11,50	
B 098 070	25,00	18,00	8,00		B 262 225	66,67	57,15	4,30	
B 100 062	25,40	15,87	7,65		B 271 240	69,00	61,00	8,50	
B 102 070-1	26,00	18,00	6,40	ISO 5597	B 275 225	69,85	57,15	10,00	
B 102 070	26,00	18,00	7,00		B 275 196	70,00	50,00	14,50	
B 106 078	27,00	20,00	6,40		B 275 216	70,00	55,00	10,50	
B 110 078-1	28,00	20,00	6,40	ISO 5597	B 275 236	70,00	60,00	8,00	
B 110 078	28,00	20,00	7,00		B 287 212	73,02	53,97	14,80	
B 118 078	30,00	20,00	8,50		B 295 216	75,00	55,00	14,50	
B 118 086-1	30,00	22,00	6,40	ISO 5597	B 295 248-1	75,00	63,00	9,60	
B 118 086	30,00	22,00	7,00		B 295 255-1	75,00	65,00	8,50	
B 118 068	30,16	17,46	10,00		B 300 225-1	76,20	57,15	13,50	
B 125 075-1	31,75	19,05	8,50		B 314 236	80,00	60,00	14,50	
B 125 094	32,00	24,00	7,50		B 314 255	80,00	65,00	11,50	
B 129 098-1	33,00	25,00	6,40	ISO 5597	B 314 259	80,00	66,00	11,00	
B 134 094	34,00	24,00	6,50		B 314 275-1	80,00	70,00	8,00	
B 137 100	34,92	25,40	6,85		B 322 275-1	82,00	70,00	9,60	
B 137 086	35,00	22,00	10,00		B 330 275	84,00	70,00	12,50	
B 137 098	35,00	25,00	9,00		B 334 255	85,00	65,00	14,50	
B 137 106	35,00	27,00	6,50		B 334 275-1	85,00	70,00	12,00	
B 141 110	36,00	28,00	6,40	ISO 5597	B 334 295-1	85,00	75,00	8,00	
B 147 118	37,50	30,00	6,50		B 350 287	88,90	73,02	12,50	
B 150 100	38,10	25,40	10,00		B 354 275	90,00	70,00	14,50	
B 150 125	38,10	31,75	6,75		B 354 314	90,00	80,00	8,00	
B 157 118	40,00	30,00	7,50		B 362 314	92,00	80,00	9,60	
B 157 125-1	40,00	32,00	6,40		B 362 300	92,07	76,20	10,00	
B 157 125	40,00	32,00	9,00		B 374 334	95,00	85,00	8,00	
B 169 137	43,00	35,00	6,40		B 375 300	95,25	76,20	14,80	
B 169 141	43,00	36,00	6,50		B 377 314	96,00	80,00	10,50	
B 173 141	44,00	36,00	6,40	ISO 5597	B 393 314	100,00	80,00	14,50	
B 175 112	44,45	28,57	11,60		B 400 325-1	101,60	82,55	14,80	
B 175 125	44,45	31,75	9,52		B 401 354	102,00	90,00	9,60	
B 177 118-1	45,00	30,00	9,00		B 425 350	107,95	88,90	12,70	
B 177 137-5	45,00	35,00	8,00		B 425 377	108,00	96,00	12,50	
B 188 157	48,00	40,00	6,50		B 444 393	113,00	100,00	13,50	
B 196 118	50,00	30,00	14,50		B 452 413	115,00	105,00	11,00	
B 196 137	50,00	35,00	11,50		B 460 413	117,00	105,00	12,50	
B 196 149	50,00	38,00	9,50		B 472 413	120,00	105,00	12,00	
B 196 157-3	50,00	40,00	8,00	ISO 5597	B 492 413	125,00	105,00	12,50	
B 196 157	50,00	40,00	11,00		B 492 433	125,00	110,00	12,00	
B 196 165	50,00	42,00	6,40		B 492 452	125,00	115,00	8,00	
B 200 137-1	50,80	34,92	10,00		B 531 492	135,00	125,00	8,50	
B 200 150-1	50,80	38,10	12,40		B 550 500	139,70	127,00	10,00	
B 208 177	53,00	45,00	6,50		B 551 472	140,00	120,00	12,50	
B 212 150-1	53,97	38,10	11,50		B 551 511	140,00	130,00	8,00	
B 212 181	54,00	46,00	8,00		B 620 570	157,70	145,00	10,00	
B 216 177	55,00	45,00	8,00	ISO 5597	B 767 708	195,00	180,00	12,50	
B 225 162	57,15	41,27	11,60						

**Web:** <http://cat.hansa-flex.com/en/BDICHTUNG>

#### Product versions:

**B NEI** - Rod seal B-NEI, (1) Seal: fabric-reinforced NBR

**B M** - Rod seal B-M, fabric-reinforced NBR

**B FPM-C** - Rod seal B-FPM/C, FPM-C

## B NEI FPM

## Rod seal B-NEI-FPM

Low-friction seal. Extremely good sealing effect at low pressure. Simple solution.

**Design:** rod seal  
**Operating pressure:** up to 400 bar  
**Sliding speed max.:** 0,5 m/s  
**Temp. min.:** -30 °C  
**Temp. max.:** 110 °C  
**Media:** Mineral oils, Water emulsions  
**Installation:** in closed grooves A, in open grooves B  
**Material:** (1) Seal: FPM, (2) Support ring: acetal resin / PTBR  
**Application:** Hydraulics

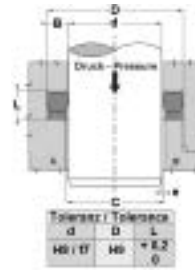

Spaltmaß / Clearance	
Druck / Pressure (bar)	e (mm)
160	≤ 0,40
250	≤ 0,20
400	≤ 0,12

**Ordering information:** For special operating conditions (fluid, temperature, pressure ...) please contact us.

Identification	D mm	d mm	L mm
B 216 157-NEI FPM	55	40	8,0
B 255 196-NEI FPM	65	50	11,0
B 295 236-NEI FPM	75	60	13,0
B 314 236-NEI FPM	80	60	14,5
B 334 275-NEI FPM	85	70	12,5
B 452 393-NEI FPM	115	100	12,5

**Web:** <http://cat.hansa-flex.com/en/BNEIFPM>

**Product versions:**

**B NEI - Rod seal B-NEI, (1) Seal:** fabric-reinforced NBR

## B NEI

## Rod seal B-NEI

Low-friction seal. Extremely good sealing effect at low pressure. Simple solution.

**Design:** rod seal  
**Operating pressure:** up to 400 bar  
**Sliding speed max.:** 0,5 m/s  
**Temp. min.:** -30 °C  
**Temp. max.:** 110 °C  
**Media:** Mineral oils, Water emulsions  
**Installation:** in closed grooves A, in open grooves B  
**Material:** (1) Seal: fabric-reinforced NBR, (2) Support ring: acetal resin / PTBR  
**Application:** Hydraulics

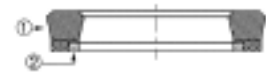
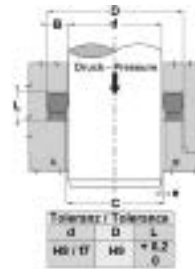

Spaltmaß / Clearance	
Druck / Pressure (bar)	e (mm)
160	≤ 0,40
250	≤ 0,20
400	≤ 0,12

**Ordering information:** For special operating conditions (fluid, temperature, pressure ...) please contact us. Alternative material possible: FPM.

Identification	D mm	d mm	L mm	Standard grooves	Identification	D mm	d mm	L mm	Standard grooves
B 094 063-NEI	24,00	16,00	7,00		B 187 125-NEI	47,62	31,75	11,60	
B 106 059-NEI	27,00	15,00	7,00		B 188 141-NEI	48,00	36,00	9,50	
B 110 070-NEI	28,00	18,00	6,30		B 188 141-1-NEI	48,00	36,00	12,00	
B 110 078-1-NEI	28,00	20,00	6,40		B 188 157-NEI	48,00	40,00	6,50	
B 110 078-NEI	28,00	20,00	7,00		B 196 137-NEI	50,00	35,00	11,50	
B 118 070-NEI	30,00	18,00	7,50		B 196 157-3-NEI	50,00	40,00	8,00	ISO 5597
B 118 078-NEI	30,00	20,00	8,50		B 196 157-1-NEI	50,00	40,00	10,00	
B 118 086-NEI	30,00	22,00	7,00		B 196 157-NEI	50,00	40,00	11,00	
B 125 086-NEI	32,00	22,00	10,00		B 200 150-NEI	50,80	38,10	10,00	
B 129 098-1-NEI	33,00	25,00	6,40		B 212 150-5-NEI	53,97	38,10	10,50	
B 133 086-NEI	34,00	22,00	9,50		B 212 175-1-NEI	53,97	44,45	7,62	
B 137 086-NEI	35,00	22,00	10,00		B 216 157-NEI	55,00	40,00	8,00	
B 137 098-NEI	35,00	25,00	9,00		B 216 157-1-NEI	55,00	40,00	11,00	
B 141 110-NEI	36,00	28,00	6,40		B 216 177-NEI	55,00	45,00	8,00	ISO 5597
B 149 110-1-NEI	38,00	28,00	8,00		B 216 177-1-NEI	55,00	45,00	11,00	
B 149 118-NEI	38,00	30,00	6,40		B 224 177-NEI	57,00	45,00	10,00	
B 150 100-NEI	38,10	25,40	10,00		B 236 157-NEI	60,00	40,00	14,50	
B 156 112-NEI	39,68	28,57	9,25		B 236 177-NEI	60,00	45,00	10,50	
B 157 110-NEI	40,00	28,00	9,50		B 236 196-NEI	60,00	50,00	8,00	ISO 5597
B 157 118-NEI	40,00	30,00	7,50		B 236 196-1-NEI	60,00	50,00	10,00	
B 157 118-1-NEI	40,00	30,00	10,50		B 244 196-1-NEI	62,00	50,00	9,50	
B 157 125-1-NEI	40,00	32,00	6,00		B 255 177-NEI	65,00	45,00	14,50	
B 157 125-NEI	40,00	32,00	9,00		B 255 196-NEI	65,00	50,00	11,00	
B 169 137-NEI	43,00	35,00	6,40		B 255 216-1-NEI	65,00	55,00	8,00	
B 169 141-NEI	43,00	36,00	6,50		B 255 216-NEI	65,00	55,00	11,00	
B 173 141-NEI	44,00	36,00	6,40	ISO 5597	B 273 236-NEI	69,50	60,00	7,00	
B 177 118-1-NEI	45,00	30,00	9,00		B 275 225-NEI	69,85	57,15	10,00	
B 177 125-NEI	45,00	32,00	10,00		B 275 196-NEI	70,00	50,00	14,50	
B 177 137-3-NEI	45,00	35,00	10,50		B 275 216-NEI	70,00	55,00	10,50	
B 181 141-NEI	46,00	36,00	8,50		B 275 236-NEI	70,00	60,00	8,00	

## B NEI

(Continued)

## Rod seal B-NEI

Identification	D	d	L	Standard grooves	Identification	D	d	L	Standard grooves
	mm	mm	mm			mm	mm	mm	
B 275 236-1-NEI	70,00	60,00	11,00		B 413 354-NEI	105,00	90,00	9,50	
B 275 236-2-NEI	70,00	60,00	13,00		B 413 354-1-NEI	105,00	90,00	12,50	ISO 5597
B 279 220-NEI	71,00	56,00	10,50		B 418 354-NEI	106,20	90,00	10,80	
B 283 236-NEI	72,00	60,00	10,00		B 433 354-NEI	110,00	90,00	12,50	
B 295 216-NEI	75,00	55,00	14,50		B 433 374-NEI	110,00	95,00	12,50	
B 295 236-NEI	75,00	60,00	13,00		B 441 374-NEI	112,00	95,00	12,00	
B 295 248-NEI	75,00	63,00	11,00		B 444 393-NEI	113,00	100,00	13,50	
B 295 255-NEI	75,00	65,00	13,50		B 452 374-NEI	115,00	95,00	14,50	
B 299 220-NEI	76,00	56,00	14,50		B 452 393-1-NEI	115,00	100,00	11,50	
B 303 255-NEI	77,00	65,00	9,60		B 452 393-NEI	115,00	100,00	12,50	
B 307 248-NEI	78,00	63,00	12,50	ISO 5597	B 472 393-1-NEI	120,00	100,00	12,00	
B 314 236-NEI	80,00	60,00	14,50		B 472 393-NEI	120,00	100,00	14,50	
B 314 255-NEI	80,00	65,00	11,50		B 492 413-NEI	125,00	105,00	12,50	
B 314 255-2-NEI	80,00	65,00	12,50		B 492 433-NEI	125,00	110,00	12,00	
B 314 275-1-NEI	80,00	70,00	8,00		B 511 433-NEI	130,00	110,00	12,50	
B 314 275-NEI	80,00	70,00	13,00		B 522 472-NEI	132,70	120,00	10,00	
B 322 275-NEI	82,00	70,00	10,50		B 531 433-NEI	135,00	110,00	15,50	
B 326 248-NEI	83,00	63,00	14,50		B 531 472-NEI	135,00	120,00	12,50	
B 330 275-NEI	84,00	70,00	12,50		B 551 472-NEI	140,00	120,00	12,50	
B 334 275-1-NEI	85,00	70,00	12,00		B 570 511-1-NEI	145,00	130,00	13,00	
B 334 275-NEI	85,00	70,00	12,50		B 590 492-NEI	150,00	125,00	14,50	
B 334 295-2-NEI	85,00	75,00	11,00		B 620 570-NEI	157,70	145,00	10,00	
B 354 295-NEI	90,00	75,00	11,50		B 629 531-NEI	160,00	135,00	14,00	
B 354 295-1-NEI	90,00	75,00	12,80		B 629 551-NEI	160,00	140,00	12,50	
B 366 314-NEI	93,00	80,00	14,50		B 629 551-1-NEI	160,00	140,00	14,50	
B 374 295-NEI	95,00	75,00	14,50		B 669 590-1-NEI	170,00	150,00	14,50	
B 374 314-NEI	95,00	80,00	12,00		B 688 629-NEI	175,00	160,00	16,00	
B 374 334-NEI	95,00	85,00	8,00		B 708 629-NEI	180,00	160,00	14,50	
B 377 314-NEI	96,00	80,00	10,50		B 787 708-NEI	200,00	180,00	14,50	
B 393 314-1-NEI	100,00	80,00	12,00		B 826 708-1-NEI	210,00	180,00	20,50	
B 393 314-NEI	100,00	80,00	14,50		B 826 748-NEI	210,00	190,00	14,50	
B 393 334-1-NEI	100,00	85,00	12,00		B 866 787-NEI	220,00	200,00	14,50	
B 393 354-NEI	100,00	90,00	11,00		B 944 826-NEI	240,00	210,00	22,50	
B 413 334-NEI	105,00	85,00	14,50		B 984 866-NEI	250,00	220,00	20,50	

Web: <http://cat.hansa-flex.com/en/BNEI>

## Product versions:

B Dichtung - Rod seal B, fabric-reinforced NBR

B M - Rod seal B-M, fabric-reinforced NBR

B NEI FPM - Rod seal B-NEI-FPM, (1) Seal: FPM

## B FPM-K

## Rod seal B-FPM/K



Spaltmaß / Clearance	
Druck / Pressure (bar)	e (mm)
199	< 0,2
299	< 0,1



Low-friction seal. Extremely good sealing effect at low pressure. Simple solution.

**Design:** rod seal  
**Operating pressure:** up to 250 bar  
**Sliding speed max.:** 0,5 m/s  
**Temp. min.:** -30 °C  
**Temp. max.:** 150 °C  
**Media:** Mineral oils, Water emulsions  
**Installation:** in closed grooves in open grooves  
**Material:** FPM-K  
**Application:** Hydraulics

Identification	D	d	L
	mm	mm	mm
B 137 098 FPM-K	35,0	35,00	9,0
B 196 137 FPM-K	50,0	35,00	11,5
B 330 275 FPM-K	84,0	70,00	12,5
B 492 413 FPM-K	125,0	105,00	12,5

Web: <http://cat.hansa-flex.com/en/BFPMK>

## B FPM-C

## Rod seal B-FPM/C

Low-friction seal. Extremely good sealing effect at low pressure. Simple solution.

**Design:** rod seal  
**Operating pressure:** up to 250 bar  
**Sliding speed max.:** 0,5 m/s  
**Temp. min.:** -10 °C  
**Temp. max.:** 150 °C  
**Media:** Mineral oils, Water emulsions  
**Installation:** in closed grooves in open grooves  
**Material:** FPM-C  
**Application:** Hydraulics

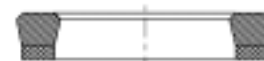

Spaltmaß / Clearance Druck / Pressure (bar)	e (mm)
100	< 0,2
250	< 0,1

Identification	D mm	d mm	L mm
B 094 063-1 FPM-C	24	16	6,4
B 102 070-1 FPM-C	26	18	6,4
B 110 078-1 FPM-C	28	20	6,4
B 118 086-1 FPM-C	30	22	6,4
B 129 098-1 FPM-C	33	25	6,4
B 141 110 FPM-C	36	28	6,4
B 149 118 FPM-C	38	30	6,4
B 157 118 FPM-C	40	30	7,5
B 157 125-1 FPM-C	40	32	6,4
B 169 137 FPM-C	43	35	6,4
B 173 141 FPM-C	44	36	6,4

Identification	D mm	d mm	L mm
B 188 157 FPM-C	48	40	6,4
B 196 157 FPM-C	50	40	11,0
B 216 177 FPM-C	55	45	8,0
B 236 196 FPM-C	60	50	8,0
B 236 196-1 FPM-C	60	50	10,0
B 255 216-1 FPM-C	65	55	8,0
B 275 236 FPM-C	70	60	8,0
B 283 236 FPM-C	72	60	9,6
B 322 275-1 FPM-C	82	70	9,6
B 362 314 FPM-C	92	80	9,6

**Web:** <http://cat.hansa-flex.com/en/BFPMC>

**Product versions:**

**B Dichtung** - Rod seal B, fabric-reinforced NBR  
**B M** - Rod seal B-M, fabric-reinforced NBR  
**B NEI** - Rod seal B-NEI, (1) Seal: fabric-reinforced NBR

## B M

## Rod seal B-M

Low-friction seal. Extremely good sealing effect at low pressure. Simple solution.

**Design:** rod seal  
**Operating pressure:** up to 250 bar  
**Sliding speed max.:** 0,5 m/s  
**Temp. min.:** -30 °C  
**Temp. max.:** 110 °C  
**Media:** Mineral oils, Water emulsions  
**Installation:** in closed grooves A, in open grooves B  
**Material:** fabric-reinforced NBR  
**Application:** Hydraulics

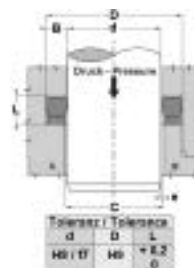

Spaltmaß / Clearance Druck / Pressure (bar)	e (mm)
100	< 0,2
250	< 0,1

**Ordering information:** For special operating conditions (fluid, temperature, pressure ...) please contact us. Alternative material possible: FPM.

Identification	D mm	d mm	L mm	Standard grooves
B 047 019-M	12,00	5,00	6,40	
B 051 024-M	13,00	6,00	6,40	
B 059 031-M	15,00	8,00	6,40	
B 066 039-M	17,00	10,00	6,40	
B 075 047-M	19,00	12,00	6,40	
B 086 055-M	22,00	14,00	6,40	
B 090 059-M	23,00	15,00	6,40	
B 094 063-1-M	24,00	16,00	6,40	ISO 5597
B 102 070-1-M	26,00	18,00	6,40	ISO 5597
B 110 078-1-M	28,00	20,00	6,40	ISO 5597
B 118 086-1-M	30,00	22,00	6,40	ISO 5597
B 129 098-1-M	33,00	25,00	6,40	ISO 5597
B 141 110-M	36,00	28,00	6,40	
B 149 118-M	38,00	30,00	6,40	
B 157 125-1-M	40,00	32,00	6,40	
B 169 137-M	43,00	35,00	6,40	
B 173 141-M	44,00	36,00	6,40	
B 188 157-M	48,00	40,00	6,40	
B 196 165-M	50,00	42,00	6,40	
B 216 177-M	55,00	45,00	8,00	
B 236 196-M	60,00	50,00	8,00	ISO 5597
B 255 216-1-M	65,00	55,00	8,00	
B 259 220-M	66,00	56,00	8,00	
B 275 236-M	70,00	60,00	8,00	
B 295 248-1-M	75,00	63,00	9,60	
B 303 255-M	77,00	65,00	9,60	
B 322 275-1-M	82,00	70,00	9,60	
B 342 295-M	87,00	75,00	9,60	
B 362 314-M	92,00	80,00	9,60	
B 381 334-M	97,00	85,00	9,60	
B 401 354-M	102,00	90,00	9,60	
B 452 393-2-M	115,00	100,00	12,00	
B 492 433-M	125,00	110,00	12,00	
B 511 452-M	130,00	115,00	12,00	
B 551 492-M	140,00	125,00	12,00	
B 629 551-2-M	160,00	140,00	16,00	
B 669 590-M	170,00	150,00	16,00	
B 708 629-1-M	180,00	160,00	16,00	
B 787 708-1-M	200,00	180,00	16,00	
B 866 787-1-M	220,00	200,00	16,00	

**Web:** <http://cat.hansa-flex.com/en/BM>

**Product versions:**

**B Dichtung** - Rod seal B, fabric-reinforced NBR  
**B NEI** - Rod seal B-NEI, (1) Seal: fabric-reinforced NBR

## B GS

## Rod seal B GS

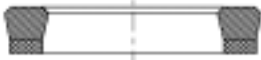

Spaltmaß / Clearance	
Druck / Pressure (bar)	e (mm)
199	< 0,2
259	< 0,1

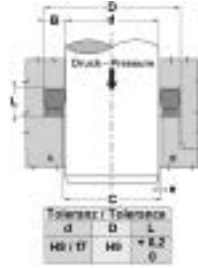

Simple solution. Low-friction seal. Extremely good sealing effect at low pressure.

**Operating pressure:** up to 250 bar

**Sliding speed max.:** 0,5 m/s

**Temp. min.:** -30 °C

**Temp. max.:** 110 °C

**Media:** Mineral oils, Water emulsions

**Installation:** in closed or open grooves

**Material:** (1) Seal: fabric-reinforced NBR, (2) Support ring: acetal resin / PTBR

Identification	D mm	d mm	L mm
B 208 165-GS	53,00	42,00	10,00
B 267 236-P	68,00	60,00	11,00
B 275 216-GS	70,00	55,00	10,50
B 314 255-GS	80,00	65,00	11,50
B 334 255-GS	85,00	65,00	14,50
B 334 275-GS	85,00	70,00	12,00
B 366 307-GS	93,00	78,00	11,50
B 374 314-GS	95,00	80,00	12,00
B 748 669-GS	190,00	170,00	14,50

**Web:** <http://cat.hansa-flex.com/en/BGS>



## Chevron ring CH

High temperature resistance. for difficult working conditions such as hydraulic shocks, Strong vibrations or poor surfaces.

**Design:** Chevron ring

**Operating pressure:** up to 400 bar

**Sliding speed max.:** 0,5 m/s

**Temp. min.:** -30 °C

**Temp. max.:** 110 °C

**Media:** Mineral oils, Water emulsions

**Installation:** in open grooves

**Material:** (1) Chevron ring: 1 x NBR, + 2 x fabric-reinforced NBR,  
(2) Support ring: acetal resin / PTBR, (3) Thrust ring: laminated fabric-reinforced NBR

**Application:** Hydraulics

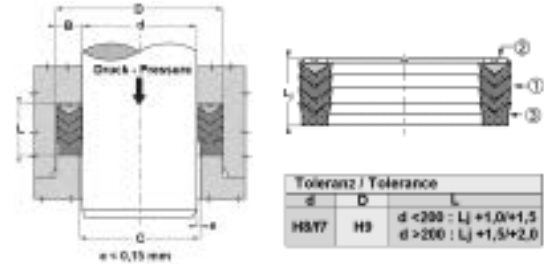

**Ordering information:** For special operating conditions (fluid, temperature, pressure ...) please contact us. Alternative material possible: PPM.

Identification	d mm	D mm	L mm	Identification	d mm	D mm	L mm
CH-098 047-B	12,00	25,00	14,32	CH-334 261	66,30	85,00	24,13
CH-100 050	12,70	25,40	19,05	CH-334 275	70,00	85,00	28,00
CH-106 055-B	14,00	27,00	14,32	CH-350 275	69,85	88,90	25,40
CH-112 071	18,25	28,57	16,05	CH-350 300	76,20	88,90	16,27
CH-118 078	20,00	30,00	21,50	CH-354 255	65,00	90,00	30,00
CH-125 078	20,00	32,00	18,20	CH-354 275	70,00	90,00	30,00
CH-125 086	22,00	32,00	18,13	CH-354 295	75,00	90,00	22,50
CH-137 098	25,00	35,00	17,30	CH-374 295	75,00	95,00	30,00
CH-141 078	20,00	36,00	24,00	CH-374 314	80,00	95,00	17,50
CH-157 098	25,00	40,00	19,84	CH-393 295	75,00	100,00	30,00
CH-157 110	28,00	40,00	17,00	CH-393 314	80,00	100,00	30,00
CH-157 118	30,00	40,00	21,80	CH-400 325	82,55	101,60	28,97
CH-162 112	28,57	41,27	19,84	CH-400 350	88,90	101,60	17,00
CH-165 118	30,00	42,00	20,00	CH-413 354	90,00	105,00	31,75
CH-165 125	32,00	42,00	17,30	CH-425 350-1	88,90	107,95	33,33
CH-175 125	31,75	44,45	19,05	CH-433 354	90,00	110,00	26,88
CH-177 137	35,00	45,00	21,78	CH-433 354-1	90,00	110,00	25,00
CH-187 137	34,92	47,62	20,64	CH-433 374	95,00	110,00	24,00
CH-188 125-B	32,00	48,00	17,63	CH-450 393	100,00	114,30	20,64
CH-196 118	30,00	50,00	29,37	CH-452 354-B	90,00	115,00	27,41
CH-196 137	35,00	50,00	22,50	CH-452 393	100,00	115,00	25,30
CH-196 157	40,00	50,00	17,30	CH-472 393	100,00	120,00	28,00
CH-200 137	34,92	50,80	24,21	CH-492 393	100,00	125,00	36,90
CH-200 150	38,10	50,80	19,45	CH-492 393-B	100,00	125,00	27,40
CH-204 141-B	36,00	52,00	17,60	CH-492 413	105,00	125,00	29,76
CH-212 150	38,10	53,97	25,27	CH-500 450	114,30	127,00	18,41
CH-216 153	39,00	55,00	25,40	CH-511 409	104,00	130,00	37,00
CH-216 157	40,00	55,00	22,62	CH-519 433	110,00	132,00	36,50
CH-216 157-1	40,00	55,00	26,19	CH-551 433	110,00	140,00	41,20
CH-220 157-B	40,00	56,00	17,63	CH-551 452	115,00	140,00	37,12
CH-225 150	38,10	57,15	28,70	CH-551 472	120,00	140,00	30,00
CH-225 175	44,45	57,15	21,83	CH-570 492	125,00	145,00	29,62
CH-236 157	40,00	60,00	30,00	CH-590 492-B	125,00	150,00	27,40
CH-236 177	45,00	60,00	22,22	CH-590 511	130,00	150,00	29,76
CH-236 188	48,00	60,00	25,00	CH-610 492	125,00	155,00	34,50
CH-237 175	44,45	60,32	27,80	CH-610 511	130,00	155,00	40,00
CH-250 200	50,80	63,50	19,84	CH-610 531	135,00	155,00	30,55
CH-255 177	45,00	65,00	28,00	CH-629 551	140,00	160,00	28,50
CH-262 200	50,80	66,67	23,00	CH-649 551	140,00	165,00	41,95
CH-262 200-1	50,80	66,67	25,27	CH-669 551-B	140,00	170,00	32,97
CH-263 216	55,00	67,00	25,00	CH-669 570	145,00	170,00	38,10
CH-275 196	50,00	70,00	30,00	CH-669 590	150,00	170,00	30,56
CH-275 196-B	50,00	70,00	21,94	CH-700 600	152,40	177,80	33,34
CH-275 200	50,80	69,85	33,50	CH-708 590	150,00	180,00	40,00
CH-275 216	55,00	70,00	26,50	CH-708 629	160,00	180,00	30,00
CH-275 225	57,15	69,85	19,05	CH-767 669	170,00	195,00	37,50
CH-279 220	56,00	71,00	17,20	CH-787 669	170,00	200,00	50,00
CH-295 216	55,00	75,00	30,00	CH-787 669-1	170,00	200,00	43,00
CH-295 216-1	55,00	75,00	38,50	CH-866 787	200,00	220,00	30,00
CH-299 220-B	56,00	76,00	21,95	CH-944 826	210,00	240,00	34,50
CH-299 236	60,00	76,00	29,00	CH-944 826-1	210,00	240,00	42,10
CH-300 225	57,15	76,20	32,54	CH-984 866	220,00	250,00	52,00
CH-314 236	60,00	80,00	32,15	CH-125 91141	290,00	320,00	50,80
CH-314 250	63,50	80,00	28,00	CH-125 91181	300,00	320,00	32,00
CH-326 248-B	63,00	83,00	21,94	CH-153 51377	350,00	390,00	61,60
CH-334 255	65,00	85,00	29,00	CH-196 81811	460,00	500,00	53,40

**Web:** <http://cat.hansa-flex.com/en/CH>

**Product versions:**

CH NEI - Chevron ring CH-NEI, (1) Chevron ring: 1 x NBR, + 2 x fabric-reinforced NBR

**CH NEO**

**Chevron ring CH-NEO**

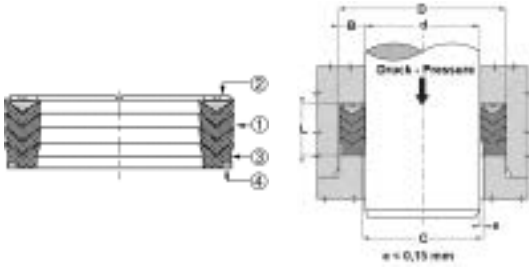

**Design:** Chevron ring  
**Operating pressure:** up to 500 bar  
**Sliding speed max.:** 0,5 m/s  
**Temp. min.:** -30 °C  
**Temp. max.:** 110 °C  
**Media:** Mineral oils, Water emulsions on multi-part pistons  
**Installation:**  
**Application:** Hydraulics

Identification	d mm	D mm	L mm
CH-375 325-NEO	82,55	95,25	21,72
CH-400 337-NEO	85,72	101,60	26,75
CH-425 350-NEO	88,90	107,95	31,00
CH-450 350-NEO	88,90	114,30	35,32
CH-450 375-NEO	95,25	114,30	25,40
CH-450 387-NEO	98,42	114,42	26,59
CH-500 425-NEO	107,95	127,00	30,00
CH-550 450-1-NEO	114,30	139,70	33,50

Identification	d mm	D mm	L mm
CH-551 452-NEO	115,00	140,00	37,12
CH-590 472-NEO	120,00	150,00	44,00
CH-600 500-NEO	127,00	152,40	38,63
CH-629 511-1-NEO	130,00	160,00	43,50
CH-826 708-B-NEO	180,00	210,00	32,97
CH-875 750-NEO	190,50	222,25	50,00
CH-110 2984B-NEO	250,00	280,00	32,97

BD = Working pressure

**Web:** <http://cat.hansa-flex.com/en/CHNEO>

**CH NEI**

**Chevron ring CH-NEI**

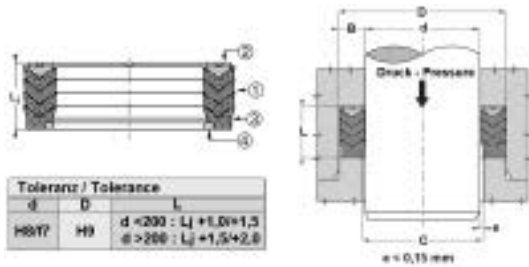

Toleranz / Tolerance		
d	D	L
H9/f7	H9	d < 200 : Lj +1,0/+1,3 d > 200 : Lj +1,5/+2,0

High temperature resistance. for difficult working conditions such as hydraulic shocks, Strong vibrations or poor surfaces.

**Design:** Chevron ring  
**Operating pressure:** up to 400 bar  
**Sliding speed max.:** 0,5 m/s  
**Temp. min.:** -30 °C  
**Temp. max.:** 110 °C  
**Media:** Mineral oils, Water emulsions  
**Installation:** in open grooves  
**Material:** (1) Chevron ring: 1 x NBR, + 2 x fabric-reinforced NBR, (2) Support ring: acetal resin / PTBR, (3) Thrust ring: laminated fabric-reinforced NBR, (4) Support ring: acetal resin / PTBR  
**Application:** Hydraulics

**Ordering information:** For special operating conditions (fluid, temperature, pressure ...) please contact us. Alternative material possible: FPM.

Identification	d mm	D mm	L mm
CH-177 118-NEI	30,00	45,00	22,20
CH-196 137-NEI	35,00	50,00	22,50
CH-200 141-NEI	36,00	51,00	24,00
CH-216 157-NEI	40,00	55,00	22,62
CH-236 177-NEI	45,00	60,00	22,22
CH-255 196-NEI	50,00	65,00	24,60
CH-255 196-1-NEI	50,00	65,00	26,00
CH-284 204-NEI	52,00	72,00	32,50
CH-295 236-NEI	60,00	75,00	19,00

Identification	d mm	D mm	L mm
CH-299 236-NEI	60,00	76,00	29,00
CH-314 236-NEI	60,00	80,00	32,15
CH-326 275-NEI	70,00	83,00	25,00
CH-334 248-NEI	63,00	85,00	32,00
CH-334 255-NEI	65,00	85,00	29,00
CH-354 275-NEI	70,00	90,00	30,00
CH-393 314-NEI	80,00	100,00	30,00
CH-413 334-1-NEI	85,00	105,00	30,00
CH-511 433-NEI	110,00	130,00	30,00

**Web:** <http://cat.hansa-flex.com/en/CHNEI>

**Product versions:**

CH - Chevron ring CH, (1) Chevron ring: 1 x NBR, + 2 x fabric-reinforced NBR

## CH1

## Chevron ring CH1

High temperature resistance. for difficult working conditions such as hydraulic shocks, Strong vibrations or poor surfaces.

**Design:** Chevron rod ring

**Operating pressure:** up to 400 bar

**Sliding speed max.:** 0,5 m/s

**Temp. min.:** -30 °C

**Temp. max.:** 110 °C

**Media:** Mineral oils, Water emulsions

**Installation:** in open grooves B

**Material:** Thrust ring: laminated fabric-reinforced NBR, (2) Chevron ring: 2 x NBR + 3 x fabric-reinforced NBR, (3) Thrust ring: laminated fabric-reinforced NBR

**Application:** Hydraulics

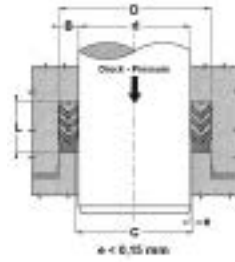

Toleranz / Tolerance		
d	D	L
H8 / F7	H9	d = 200 : Lj +1,0 / 1,5 d > 200 : Lj +1,5 / 2,0

**Ordering information:** Other sizes on request For special operating conditions (fluid, temperature, pressure ...) please contact us. Alternative material possible: FPM.

Identification	d	D	L	Identification	d	D	L
	mm	mm	mm		mm	mm	mm
CH1-008	8,00	18,0	18,5	CH1-055	55,00	70,0	22,5
CH1-010	10,00	20,0	18,5	CH1-056	56,00	71,0	22,5
CH1-012	12,00	22,0	18,5	CH1-060	60,00	75,0	22,5
CH1-014	14,00	24,0	18,5	CH1-063	63,00	78,0	22,5
CH1-015	15,00	25,0	18,5	CH1-065	65,00	80,0	22,5
CH1-016	16,00	26,0	18,5	CH1-070	70,00	85,0	22,5
CH1-018	18,00	28,0	18,5	CH1-075	75,00	90,0	22,5
CH1-020	20,00	30,0	18,5	CH1-080	80,00	95,0	22,5
CH1-022	22,00	32,0	18,5	CH1-085	85,00	100,0	22,5
CH1-025	25,00	37,0	22,5	CH1-090	90,00	105,0	22,5
CH1-028	28,00	40,0	22,5	CH1-100	100,00	115,0	30,0
CH1-030	30,00	42,0	22,5	CH1-110	110,00	125,0	30,0
CH1-032	32,00	44,0	22,5	CH1-115	115,00	130,0	30,0
CH1-035	35,00	47,0	22,5	CH1-125	125,00	140,0	34,0
CH1-036	36,00	48,0	22,5	CH1-140	140,00	155,0	34,0
CH1-040	40,00	52,0	22,5	CH1-150	150,00	170,0	40,0
CH1-042	42,00	54,0	22,5	CH1-160	160,00	180,0	40,0
CH1-045	45,00	60,0	22,5	CH1-180	180,00	200,0	40,0
CH1-048	48,00	63,0	22,5	CH1-200	200,00	220,0	40,0
CH1-050	50,00	65,0	22,5				

**Web:** <http://cat.hansa-flex.com/en/CH1>

## CH2

## Chevron ring CH2



Toleranz / Tolerance		
d	D	L
H8 / F7	H9	d ≤ 200 : Lj +1,0 / 1,5 d > 200 : Lj +1,5 / 2,0

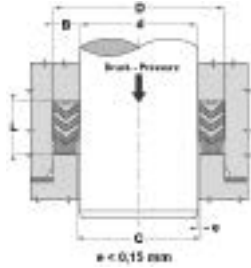

High temperature resistance. for difficult working conditions such as hydraulic shocks, Strong vibrations or poor surfaces.

**Design:** Chevron rod ring

**Operating pressure:** up to 500 bar

**Sliding speed max.:** 0,5 m/s

**Temp. min.:** -30 °C

**Temp. max.:** 110 °C

**Media:** Mineral oils, Water emulsions

**Installation:** in open grooves

**Material:** (1) Thrust ring: laminated fabric-reinforced NBR, (2) Chevron ring: 2 x NBR + 3 x fabric-reinforced NBR, (3) Support ring: acetal resin / PTBR

**Application:** Hydraulics

**Ordering information:** Other sizes on request For special operating conditions (fluid, temperature, pressure ...) please contact us. Alternative material possible: FPM.

Identification	d mm	D mm	L mm
CH2-020	20,00	32,0	22,5
CH2-022	22,00	34,0	22,5
CH2-025	25,00	40,0	22,5
CH2-028	28,00	43,0	22,5
CH2-030	30,00	45,0	22,5
CH2-032	32,00	47,0	22,5
CH2-035	35,00	50,0	22,5
CH2-036	36,00	51,0	22,5
CH2-040	40,00	55,0	22,5
CH2-042	42,00	57,0	22,5
CH2-045	45,00	65,0	27,5
CH2-050	50,00	70,0	30,0
CH2-055	55,00	75,0	30,0
CH2-056	56,00	76,0	37,0
CH2-060	60,00	80,0	37,0

Identification	d mm	D mm	L mm
CH2-063	63,00	83,0	37,0
CH2-065	65,00	85,0	40,0
CH2-070	70,00	90,0	40,0
CH2-075	75,00	95,0	40,0
CH2-080	80,00	100,0	40,0
CH2-090	90,00	110,0	40,0
CH2-100	100,00	120,0	40,0
CH2-110	110,00	130,0	40,0
CH2-120	120,00	145,0	50,0
CH2-125	125,00	150,0	46,0
CH2-140	140,00	165,0	46,0
CH2-160	160,00	190,0	60,0
CH2-180	180,00	210,0	60,0
CH2-200	200,00	230,0	60,0

**Web:** <http://cat.hansa-flex.com/en/CH2>

## DDI

## Rod seal DDI

Low-friction seal. Simple solution.

**Design:** Rod U-ring  
**Operating pressure:** up to 120 bar  
**Sliding speed max.:** 0,5 m/s  
**Design:** Inches  
**Temp. min.:** -30 °C  
**Temp. max.:** 100 °C  
**Media:** Mineral oils, Water-air  
**Installation:** in closed grooves A, in open grooves B  
**Material:** NBR 90° Shore A  
**Application:** Hydraulics + pneumatics

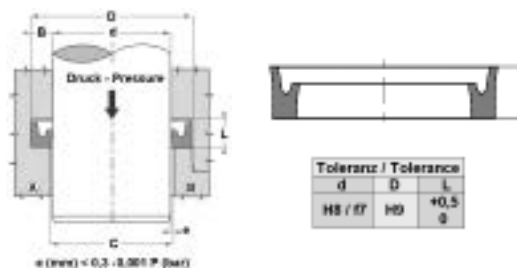

**Ordering information:** Other sizes on request We are able to produce seals with diameters of 20 to 510 mm with short lead times.

Identification	d	D	L	H	Identification	d	D	L	H
	mm	mm	mm	mm		mm	mm	mm	mm
DDI 18	4,76	11,11	5,5	3,96	DDI 125	31,75	44,45	8,0	6,35
DDI 31	7,93	14,28	5,5	3,96	DDI 137	34,93	50,80	9,5	7,93
DDI 37	9,52	16,50	5,5	3,96	DDI 150	38,10	50,80	11,0	9,52
DDI 50	12,70	21,00	7,0	5,10	DDI 156	39,69	55,96	11,0	9,52
DDI 62	15,87	22,22	6,0	4,76	DDI 162	41,28	50,80	7,0	5,50
DDI 68	17,46	23,81	6,0	4,60	DDI 175	44,45	57,15	9,5	7,93
DDI 75	19,05	25,40	6,0	4,76	DDI 187	47,63	63,50	11,0	9,52
DDI 81	20,63	28,58	6,0	4,76	DDI 212	53,98	69,85	11,0	9,52
DDI 87	22,22	31,75	6,0	4,76	DDI 237	60,33	76,20	9,5	7,93
DDI 100	25,40	38,10	8,0	6,35	DDI 325	82,55	95,25	9,5	7,93
DDI 106	26,99	36,51	8,0	6,35	DDI 350	88,90	101,60	11,0	9,52

**Web:** <http://cat.hansa-flex.com/en/DDI>

## DDIM

## Rod seal DDIM

Low-friction seal. Simple solution.

**Design:** Rod U-ring  
**Operating pressure:** up to 120 bar  
**Sliding speed max.:** 0,5 m/s  
**Design:** Metric  
**Temp. min.:** -30 °C  
**Temp. max.:** 100 °C  
**Media:** Mineral oils, Water-air  
**Installation:** in closed grooves A, in open grooves B  
**Material:** NBR 90° Shore A  
**Application:** Hydraulics + pneumatics

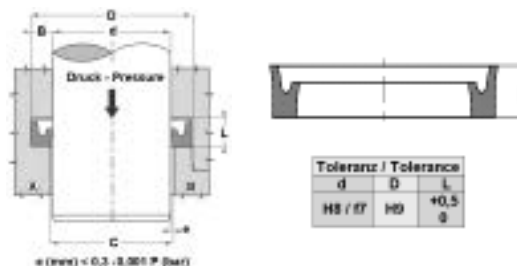

**Ordering information:** Other sizes on request

Identification	D	d	L	H	Identification	D	d	L	H
	mm	mm	mm	mm		mm	mm	mm	mm
DDIM 6 12	12	6	4,5	4,0	DDIM 45 55	55	45	7,5	7,0
DDIM 8 14	14	8	4,5	4,0	DDIM 50 60	60	50	7,5	7,0
DDIM 8 16	16	8	6,0	5,5	DDIM 56 68	68	56	7,5	7,0
DDIM 10 18	18	10	6,0	5,5	DDIM 56 68-1	68	56	9,5	8,5
DDIM 12 20	20	12	6,0	5,5	DDIM 60 72	72	60	9,5	8,5
DDIM 14 22	22	14	6,0	5,5	DDIM 63 75	75	63	9,5	8,5
DDIM 16 24	24	16	6,0	5,5	DDIM 65 77	77	65	9,5	8,5
DDIM 18 25	25	18	5,0	4,5	DDIM 70 82	82	70	9,5	8,5
DDIM 18 26	26	18	6,0	5,5	DDIM 80 92	92	80	9,5	8,5
DDIM 20 28	28	20	6,0	5,5	DDIM 90 102	102	90	9,5	8,5
DDIM 22 30	30	22	6,0	5,5	DDIM 100 112	112	100	9,5	8,5
DDIM 25 35	35	25	7,5	7,0	DDIM 100 115	115	100	11,0	10,0
DDIM 28 36	36	28	6,0	5,5	DDIM 110 130	130	110	15,0	14,0
DDIM 28 38	38	28	7,5	7,0	DDIM 125 145	145	125	15,0	14,0
DDIM 32 42	42	32	7,5	7,0	DDIM 140 160	160	140	15,0	14,0
DDIM 36 46	46	36	7,5	7,0	DDIM 160 180	180	160	15,0	14,0
DDIM 40 50	50	40	7,5	7,0	DDIM 180 200	200	180	15,0	14,0

**Web:** <http://cat.hansa-flex.com/en/DDIM>

**Product versions:**

**DDIM P** - Rod seal DDIM-P, PUR 90° Shore A

**DDIM P****Rod seal DDIM-P**

Toleranz / Tolerance		
d	D	L
H8 / f7	H9	+0,3 0

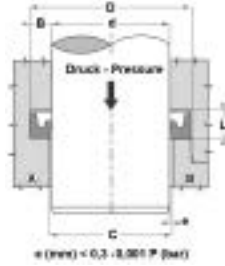

Low-friction seal. Simple solution.

- Design:** Rod lip seal  
**Operating pressure:** up to 16 bar  
**Sliding speed max.:** 1,0 m/s  
**Temp. min.:** -30 °C  
**Temp. max.:** 80 °C  
**Media:** Air  
**Installation:** in closed grooves A, in open grooves B  
**Material:** PUR 90° Shore A  
**Application:** Hydraulics + pneumatics

**Ordering information:** Other sizes on request

Identification	D	d	L	H
	mm	mm	mm	mm
DDIM 05 09-P	9	5	3,0	2,5
DDIM 06 12-P	12	6	4,5	4,0
DDIM 08 14-P	14	8	4,5	4,0
DDIM 10 16-P	16	10	5,0	4,5
DDIM 30 38-P	38	30	6,0	5,5
DDIM 50 60-P	60	50	7,5	7,0

**Web:** <http://cat.hansa-flex.com/en/DDIMP>

**Product versions:**

**DDIM - Rod seal DDIM, NBR 90° Shore A**

Low-friction seal. Simple solution. For rods and pistons.

- Design:** U-ring  
**Operating pressure:** up to 120 bar  
**Sliding speed max.:** 0,5 m/s  
**Design:** Metric  
**Temp. min.:** -30 °C  
**Temp. max.:** 100 °C  
**Media:** Mineral oils, Water-air  
**Installation:** on one-piece pistons A, on multi-part pistons B  
**Material:** Seal: NBR 90° Shore A  
**Application:** Hydraulics + pneumatics

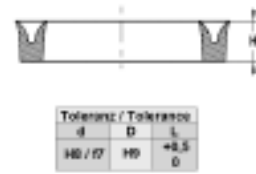
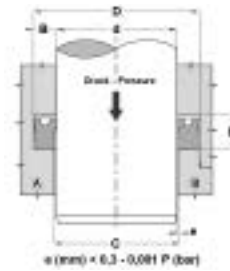

**Ordering information:** We are able to produce seals with diameters of 20 to 510 mm with short lead times.

Identification	D	d	L	H	Identification	D	d	L	H
	mm	mm	mm	mm		mm	mm	mm	mm
DUM 12 05	12	5	6,5	5,0	DUM 60 30	60	30	16,5	15,0
DUM 15 08	15	8	7,5	6,0	DUM 60 35	60	35	13,5	12,0
DUM 16 08	16	8	7,5	6,0	DUM 60 40	60	40	11,5	10,0
DUM 17 06	17	6	7,5	6,0	DUM 65 40	65	40	13,5	12,0
DUM 18 06	18	6	9,5	8,0	DUM 65 45	65	45	11,5	10,0
DUM 20 06	20	6	9,5	8,0	DUM 68 48	68	48	11,5	10,0
DUM 20 10	20	10	9,5	8,0	DUM 70 46	70	46	13,5	12,0
DUM 22 10	22	10	7,5	6,0	DUM 70 50	70	50	11,5	10,0
DUM 24 12	24	12	7,5	6,0	DUM 75 55	75	55	11,5	10,0
DUM 25 08	25	8	7,5	6,0	DUM 80 55	80	55	13,5	12,0
DUM 25 10	25	10	11,5	10,0	DUM 80 60	80	60	11,5	10,0
DUM 26 10	26	10	9,5	8,0	DUM 85 55	85	55	16,5	15,0
DUM 28 12	28	12	11,5	10,0	DUM 85 65	85	65	11,5	10,0
DUM 28 14	28	14	11,5	10,0	DUM 90 60	90	60	16,5	15,0
DUM 30 10	30	10	11,5	10,0	DUM 90 65	90	65	13,5	12,0
DUM 30 13	30	13	11,5	10,0	DUM 90 70	90	70	11,5	10,0
DUM 30 15	30	15	9,5	8,0	DUM 95 75	95	75	11,5	10,0
DUM 30 15-1	30	15	11,5	10,0	DUM 100 075	100	75	16,5	15,0
DUM 30 18	30	18	11,5	10,0	DUM 100 080	100	80	11,5	10,0
DUM 32 14	32	14	11,5	10,0	DUM 105 080	105	80	13,5	12,0
DUM 32 16	32	16	9,5	8,0	DUM 110 080	110	80	16,5	15,0
DUM 34 18	34	18	9,5	8,0	DUM 110 085	110	85	13,5	12,0
DUM 34 22	34	22	11,5	10,0	DUM 110 090	110	90	11,5	10,0
DUM 35 12	35	12	13,5	12,0	DUM 115 085	115	85	16,5	15,0
DUM 35 15	35	15	11,5	10,0	DUM 115 095	115	95	11,5	10,0
DUM 35 20	35	20	11,5	10,0	DUM 120 090	120	90	16,5	15,0
DUM 36 16	36	16	11,5	10,0	DUM 120 100	120	100	11,5	10,0
DUM 36 20	36	20	9,5	8,0	DUM 125 095	125	95	16,5	15,0
DUM 38 17	38	38	11,5	10,0	DUM 130 100	130	100	16,5	15,0
DUM 38 18	38	18	11,5	10,0	DUM 140 110	140	110	16,5	15,0
DUM 38 22	38	22	11,5	10,0	DUM 140 120	140	120	11,5	10,0
DUM 40 18	40	18	11,5	10,0	DUM 145 115	145	115	13,5	12,0
DUM 40 20	40	20	11,5	10,0	DUM 150 120	150	120	16,5	15,0
DUM 40 25	40	25	11,5	10,0	DUM 155 125	155	125	16,5	15,0
DUM 42 22	42	22	11,5	10,0	DUM 160 130	160	130	16,5	15,0
DUM 42 25	42	25	9,5	8,0	DUM 160 135	160	135	19,5	18,0
DUM 43 20	43	20	13,5	12,0	DUM 170 140	170	140	16,5	15,0
DUM 45 25	45	25	11,5	10,0	DUM 175 145	175	145	16,5	15,0
DUM 45 30	45	30	11,5	10,0	DUM 180 150	180	150	16,5	15,0
DUM 45 32	45	32	11,5	10,0	DUM 190 160	190	160	16,5	15,0
DUM 46 26	46	26	11,5	10,0	DUM 200 170	200	170	16,5	15,0
DUM 48 28	48	28	11,5	10,0	DUM 210 180	210	180	23,5	22,0
DUM 50 25	50	25	13,5	12,0	DUM 220 180	220	180	21,5	20,0
DUM 50 30	50	30	11,5	10,0	DUM 220 190	220	190	16,5	15,0
DUM 50 35	50	35	11,5	10,0	DUM 230 200	230	200	16,5	15,0
DUM 52 32	52	32	11,5	10,0	DUM 240 200	240	200	21,5	20,0
DUM 55 35	55	35	11,5	10,0	DUM 250 210	250	210	21,5	20,0
DUM 56 40	56	40	11,5	10,0	DUM 280 240	280	240	21,5	20,0
DUM 58 38	58	38	11,5	10,0	DUM 320 280	320	280	21,5	20,0

**Web:** <http://cat.hansa-flex.com/en/DUM>

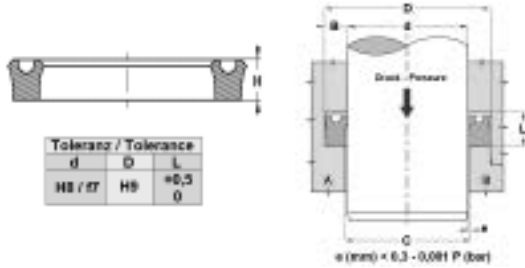
**DUM N****U- ring DUM-N**

Low-friction seal. Simple solution. For rods and pistons.

- Design:** U-ring  
**Operating pressure:** up to 120 bar  
**Sliding speed max.:** 0,5 m/s  
**Temp. min.:** -30 °C  
**Temp. max.:** 100 °C  
**Media:** Mineral oils, Water-air  
**Installation:** on one-piece pistons A, on multi-part pistons B  
**Material:** Seal: NBR 90° Shore A  
**Application:** Hydraulics + pneumatics

**Ordering information:** We are able to produce seals with diameters of 20 to 510 mm with short lead times.

Identification	D mm	d mm	L mm	H mm	Identification	D mm	d mm	L mm	H mm
DUM 12 04-N	12	4	4,5	4,0	DUM 40 30-N	40	30	5,5	5,0
DUM 13 05-N	13	5	4,5	4,0	DUM 40 32-N	40	32	4,5	4,0
DUM 14 06-N	14	6	4,5	4,0	DUM 42 32-N	42	32	5,5	5,0
DUM 15 05-N	15	5	5,5	5,0	DUM 43 33-N	43	33	5,5	5,0
DUM 15 07-N	15	7	4,5	4,0	DUM 44 32-N	44	32	6,6	6,0
DUM 16 06-N	16	6	5,5	5,0	DUM 45 30-N	45	30	8,3	7,5
DUM 16 08-N	16	8	4,5	4,0	DUM 45 33-N	45	33	6,6	6,0
DUM 18 08-N	18	8	5,5	5,0	DUM 45 35-N	45	35	5,5	5,0
DUM 18 10-N	18	10	4,5	4,0	DUM 46 36-N	46	36	5,5	5,0
DUM 20 08-N	20	8	6,6	6,0	DUM 48 38-N	48	38	5,5	5,0
DUM 20 10-N	20	10	5,5	5,0	DUM 50 35-N	50	35	8,3	7,5
DUM 20 12-N	20	12	4,5	4,0	DUM 50 38-N	50	38	6,6	6,0
DUM 22 10-N	22	10	6,6	6,0	DUM 50 40-N	50	40	5,5	5,0
DUM 22 12-N	22	12	5,5	5,0	DUM 52 40-N	52	40	6,6	6,0
DUM 22 14-N	22	14	4,5	4,0	DUM 52 42-N	52	42	5,5	5,0
DUM 24 12-N	24	12	6,6	6,0	DUM 55 40-N	55	40	8,3	7,5
DUM 24 14-N	24	14	5,5	5,0	DUM 55 43-N	55	43	6,6	6,0
DUM 24 16-N	24	16	4,5	4,0	DUM 55 45-N	55	45	5,5	5,0
DUM 25 15-N	25	15	5,5	5,0	DUM 56 46-N	56	46	5,5	5,0
DUM 25 17-N	25	17	4,5	4,0	DUM 58 46-N	58	46	6,6	6,0
DUM 26 16-N	26	16	5,5	5,0	DUM 60 45-N	60	45	8,3	7,5
DUM 26 18-N	26	18	4,5	4,0	DUM 60 48-N	60	48	6,6	6,0
DUM 27 15-N	27	15	6,6	6,0	DUM 60 50-N	60	50	5,5	5,0
DUM 28 16-N	28	16	6,6	6,0	DUM 62 50-N	62	50	6,6	6,0
DUM 28 18-N	28	18	5,5	5,0	DUM 63 51-N	63	51	6,6	6,0
DUM 28 20-N	28	20	4,5	4,0	DUM 63 53-N	63	53	5,5	5,0
DUM 30 15-N	30	15	8,3	7,5	DUM 65 50-N	65	50	8,3	7,5
DUM 30 18-N	30	18	6,6	6,0	DUM 65 53-N	65	53	6,6	6,0
DUM 30 20-N	30	20	5,5	5,0	DUM 65 55-N	65	55	5,5	5,0
DUM 30 22-N	30	22	4,5	4,0	DUM 66 54-N	66	54	6,6	6,0
DUM 32 20-N	32	20	6,6	6,0	DUM 70 55-N	70	55	8,3	7,5
DUM 32 22-N	32	22	5,5	5,0	DUM 70 60-N	70	60	5,5	5,0
DUM 32 24-N	32	24	4,5	4,0	DUM 73 63-N	73	63	5,5	5,0
DUM 33 21-N	33	21	6,6	6,0	DUM 75 60-N	75	60	8,3	7,5
DUM 33 25-N	33	25	4,5	4,0	DUM 75 65-N	75	65	5,5	5,0
DUM 34 22-N	34	22	6,6	6,0	DUM 80 65-N	80	65	8,3	7,5
DUM 34 24-N	34	24	5,5	5,0	DUM 80 70-N	80	70	5,5	5,0
DUM 34 26-N	34	26	4,5	4,0	DUM 85 70-N	85	70	8,3	7,5
DUM 35 20-N	35	20	8,3	7,5	DUM 90 75-N	90	75	8,3	7,5
DUM 35 23-N	35	23	6,6	6,0	DUM 90 80-N	90	80	5,5	5,0
DUM 35 25-N	35	25	5,5	5,0	DUM 95 80-N	95	80	8,3	7,5
DUM 35 27-N	35	27	4,5	4,0	DUM 95 85-N	95	85	5,5	5,0
DUM 36 24-N	36	24	6,6	6,0	DUM 100 085-N	100	85	8,3	7,5
DUM 36 26-N	36	26	5,5	5,0	DUM 100 090-N	100	90	5,5	5,0
DUM 36 28-N	36	28	4,5	4,0	DUM 105 090-N	105	90	8,3	7,5
DUM 37 25-N	37	25	6,6	6,0	DUM 105 095-N	105	95	5,5	5,0
DUM 37 29-N	37	29	4,5	4,0	DUM 110 095-N	110	95	8,3	7,5
DUM 38 26-N	38	26	6,6	6,0	DUM 110 100-N	110	100	5,5	5,0
DUM 38 28-N	38	28	5,5	5,0	DUM 115 100-N	115	100	8,3	7,5
DUM 38 30-N	38	30	4,5	4,0	DUM 120 105-N	120	105	8,3	7,5
DUM 40 25-N	40	25	8,3	7,5	DUM 125 110-N	125	110	8,3	7,5
DUM 40 28-N	40	28	6,6	6,0	DUM 140 125-N	140	125	8,3	7,5

**Web:** <http://cat.hansa-flex.com/en/DUMN>

**Product versions:**

**DUM N** - U- ring DUM-N, Seal: NBR 90° Shore A



Rod seal EU

Low-friction seal. High abrasion resistance. Simple solution.

- Design:** Rod U-ring
- Operating pressure:** up to 400 bar
- Sliding speed max.:** 0,5 m/s
- Design:** Metric
- Temp. min.:** -30 °C
- Temp. max.:** 80 °C
- Media:** Mineral oils
- Installation:** in closed grooves A, in open grooves B
- Material:** PUR
- Application:** Hydraulics

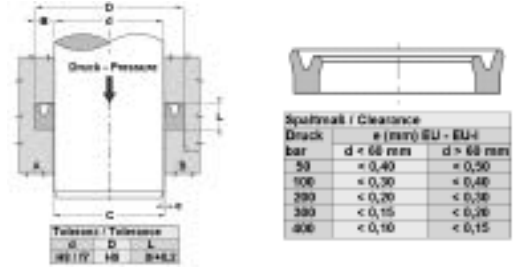

**Ordering information:** We are able to produce EU seals with diameters of 20 to 510 mm with short lead times.

Identification	D mm	d mm	L mm	Standard grooves	Identification	D mm	d mm	L mm	Standard grooves
EU 06 12-1	12,0	6	5,8		EU 35 45-2	45,0	35	13,5	
EU 06 14	14,0	6	6,3	ISO 5597	EU 35 46	46,0	35	9,0	
EU 08 14-1	14,4	8	10,5		EU 35 46-1	46,0	35	10,0	
EU 08 16	16,0	8	6,3	ISO 5597	EU 35 47	47,0	35	9,0	
EU 08 18-1	18,0	8	9,0		EU 35 50	50,0	35	11,0	
EU 10 18	18,0	10	6,3	ISO 5597	EU 36 44	44,0	36	9,0	
EU 10 20	20,0	10	8,0	ISO 5597	EU 36 46	46,0	36	8,0	ISO 5597
EU 12 17	17,0	12	4,0		EU 36 46-1	46,0	36	11,0	
EU 12 20-1	20,0	12	5,5		EU 36 48-1	48,0	36	8,0	
EU 12 20	20,0	12	6,3	ISO 5597	EU 36 48	48,0	36	9,0	
EU 12 22	22,0	12	8,0	ISO 5597	EU 36 51	51,0	36	11,0	
EU 12 22-1	22,0	12	9,0		EU 36 51-1	51,0	36	12,5	ISO 5597
EU 14 22	22,0	14	6,3	ISO 5597	EU 37 45	45,0	37	6,3	
EU 14 24	24,0	14	8,0		EU 38 44	44,0	38	5,3	
EU 15 23-1	23,0	15	6,3		EU 38 45	45,0	38	5,5	
EU 15 25-1	25,0	15	9,0		EU 38 45-1	45,0	38	7,0	
EU 16 21	20,6	16	3,6		EU 39 50	50,0	39	11,0	
EU 16 22	22,0	16	6,0		EU 40 48	48,0	40	6,3	
EU 16 24	24,0	16	6,3		EU 40 48-1	48,0	40	9,0	
EU 16 24-1	24,0	16	7,0		EU 40 50-2	50,0	40	8,0	ISO 5597
EU 16 26	26,0	16	8,0	ISO 5597	EU 40 50	50,0	40	10,0	
EU 16 26-2	26,0	16	10,0		EU 40 50-1	50,0	40	11,0	
EU 18 24	24,0	18	5,2		EU 40 50-3	50,0	40	13,5	
EU 18 24-1	24,0	18	6,0		EU 40 52	52,0	40	9,0	
EU 18 26-1	26,0	18	6,3	ISO 5597	EU 40 55	55,0	40	11,0	
EU 18 26	26,0	18	9,0		EU 40 55-1	55,0	40	12,5	ISO 5597
EU 18 28	28,0	18	8,0	ISO 5597	EU 40 60	60,0	40	13,0	
EU 18 28-1	28,0	18	9,0		EU 42 62-1	62,0	42	11,0	
EU 20 26-1	26,0	20	5,5		EU 45 53	53,0	45	6,3	
EU 20 28	28,0	20	6,3	ISO 5597	EU 45 53-2	53,0	45	11,0	
EU 20 28-1	28,0	20	7,0		EU 45 53-1	53,0	45	13,0	
EU 20 28-2	28,0	20	8,0		EU 45 55-1	55,0	45	8,0	ISO 5597
EU 20 30	30,0	20	8,0	ISO 5597	EU 45 55	55,0	45	11,0	
EU 20 30-2	30,0	20	9,0		EU 45 58-1	58,0	45	10,0	
EU 20 35	35,0	20	11,0		EU 45 60	60,0	45	11,0	
EU 22 30-1	30,0	22	6,3	ISO 5597	EU 45 60-1	60,0	45	12,5	ISO 5597
EU 22 30	30,0	22	9,0		EU 45 65-2	65,0	45	11,0	
EU 22 32-1	32,0	22	8,0	ISO 5597	EU 45 65	65,0	45	13,0	
EU 22 32	32,0	22	10,0		EU 45 65-1	65,0	45	14,5	
EU 24 34	34,0	24	8,0		EU 46 56	56,0	46	8,0	
EU 24 34-1	34,0	24	9,5		EU 50 60-1	60,0	50	8,0	
EU 25 32	32,0	25	7,0		EU 50 60	60,0	50	11,0	
EU 25 33	33,0	25	6,3		EU 50 60-2	60,0	50	13,0	
EU 25 33-3	33,0	25	7,0		EU 50 65-1	65,0	50	11,0	
EU 25 33-1	33,0	25	8,0		EU 50 65	65,0	50	12,5	ISO 5597
EU 25 33-2	33,0	25	11,0		EU 50 68-1	68,0	50	10,0	
EU 25 35	35,0	25	8,0	ISO 5597	EU 50 70	70,0	50	13,0	
EU 25 38-1	38,0	25	10,0		EU 52 62	62,0	52	11,0	
EU 25 40	40,0	25	11,0		EU 55 63-1	63,0	55	13,0	
EU 28 36	36,0	28	6,3		EU 55 65	65,0	55	8,0	
EU 28 38	38,0	28	8,0	ISO 5597	EU 55 65-1	65,0	55	11,0	
EU 28 38-1	38,0	28	9,0		EU 55 65-2	65,0	55	13,0	
EU 28 38-2	38,0	28	11,0		EU 55 65-3	65,0	55	14,5	
EU 28 40	40,0	28	9,5		EU 55 67-1	67,0	55	11,0	
EU 28 43	43,0	28	12,5	ISO 5597	EU 55 68	68,0	55	11,0	
EU 30 38	38,0	30	6,3		EU 55 70	70,0	55	11,0	
EU 30 38-1	38,0	30	9,0		EU 55 70-1	70,0	55	13,0	
EU 30 40-3	40,0	30	6,3		EU 55 75	75,0	55	13,0	
EU 30 40	40,0	30	8,0		EU 55 75-1	75,0	55	14,5	
EU 30 40-1	40,0	30	11,0		EU 56 66	66,0	56	11,0	
EU 30 43	43,0	30	10,0		EU 56 71	71,0	56	11,0	
EU 30 45-1	45,0	30	9,0		EU 56 71-1	71,0	56	12,5	
EU 32 40-1	40,0	32	6,3		EU 56 76	76,0	56	13,0	
EU 32 40	40,0	32	9,0		EU 56 76-1	76,0	56	14,5	
EU 32 42	42,0	32	8,0	ISO 5597	EU 56 76-2	76,0	56	16,0	ISO 5597
EU 32 42-1	42,0	32	11,0		EU 60 70-1	70,0	60	8,0	
EU 32 43	42,5	32	9,0		EU 60 70	70,0	60	11,0	
EU 32 45	45,0	32	11,0		EU 60 70-S	70,0	60	15,0	
EU 33 43-1	43,0	33	11,0		EU 60 72	72,0	60	9,0	
EU 32 47-1	47,0	32	11,0		EU 60 72-1	72,0	60	10,0	
EU 35 43	43,0	35	6,3		EU 60 75	75,0	60	11,0	
EU 35 43-1	43,0	35	9,0		EU 60 75-1	75,0	60	13,0	
EU 35 45	45,0	35	8,0		EU 60 77	77,0	60	12,0	
EU 35 45-1	45,0	35	11,0		EU 60 80	80,0	60	13,0	

## EU

(Continued)

## Rod seal EU

Identification	D	d	L	Standard grooves	Identification	D	d	L	Standard grooves
	mm	mm	mm			mm	mm	mm	
EU 61 69-1	69,0	61	8,5		EU 100 125	125,0	100	20,0	ISO 5597
EU 62 74-1	74,0	62	14,0		EU 105 115-1	115,0	105	11,0	
EU 63 73	73,0	63	13,0		EU 105 115-2	115,0	105	12,5	
EU 63 75	75,0	63	9,6		EU 105 115-3	115,0	105	14,5	
EU 63 78-1	78,0	63	11,0		EU 105 125	125,0	105	13,0	
EU 63 78	78,0	63	12,5	ISO 5597	EU 110 125-1	125,0	110	12,0	
EU 63 83-1	83,0	63	14,5		EU 110 125	125,0	110	16,0	
EU 63 83-2	83,0	63	16,0		EU 110 130	130,0	110	13,0	
EU 65 75-3	75,0	65	11,0		EU 110 130-1	130,0	110	16,0	ISO 5597
EU 65 77-1	77,0	65	10,0		EU 110 135	135,0	110	20,0	ISO 5597
EU 65 80	80,0	65	11,0		EU 115 135	135,0	115	13,0	
EU 65 80-1	80,0	65	13,0		EU 120 130-2	130,0	120	12,5	
EU 65 85	85,0	65	13,0		EU 120 130-5	130,0	120	15,0	
EU 65 85-1	85,0	65	14,5		EU 120 132-1	132,0	120	11,0	
EU 70 80-3	80,0	70	6,5		EU 120 135-1	135,0	120	12,5	
EU 70 80-2	80,0	70	8,0		EU 120 140	140,0	120	13,0	
EU 70 80-1	80,0	70	11,0		EU 120 140-1	140,0	120	16,0	
EU 70 80	80,0	70	13,0		EU 125 145	145,0	125	13,0	
EU 70 85-1	85,0	70	11,0		EU 125 145-1	145,0	125	16,0	ISO 5597
EU 70 85	85,0	70	12,5	ISO 5597	EU 125 150	150,0	125	15,0	
EU 70 90-2	90,0	70	16,0	ISO 5597	EU 130 140	140,0	130	8,0	
EU 73 82	82,5	73	8,0		EU 130 145-2	145,0	130	15,0	
EU 75 85	85,0	75	8,0		EU 130 150	150,0	130	13,0	
EU 75 85-1	85,0	75	13,0		EU 130 150-1	150,0	130	16,0	
EU 75 90-1	90,0	75	11,0		EU 140 150-1	150,0	140	12,5	
EU 75 90	90,0	75	13,0		EU 140 160-2	160,0	140	16,0	ISO 5597
EU 75 95	95,0	75	13,0		EU 140 165	165,0	140	20,0	ISO 5597
EU 76 84-1	84,0	76	8,5		EU 141 151-S	151,0	141	15,0	
EU 78 88-S	88,0	78	15,0		EU 150 170-1	170,0	150	14,5	
EU 80 100	100,0	80	13,0		EU 150 170-2	170,0	150	16,0	
EU 80 100-2	100,0	80	16,0	ISO 5597	EU 160 180	180,0	160	13,0	
EU 80 90	90,0	80	8,0		EU 160 180-1	180,0	160	16,0	
EU 80 90-2	90,0	80	13,0		EU 160 185	185,0	160	20,0	
EU 80 92	92,0	80	9,6		EU 162 172-S	172,0	162	15,0	
EU 80 95-3	95,0	80	10,0		EU 165 195	195,0	165	21,0	
EU 80 95-2	95,0	80	11,0		EU 170 190-1	190,0	170	16,0	
EU 80 95-1	95,0	80	12,5		EU 180 200-1	200,0	180	16,0	
EU 80 95	95,0	80	13,0		EU 180 200-2	200,0	180	20,0	
EU 85 95	95,0	85	8,0		EU 183 193-S	193,0	183	15,0	
EU 85 100-1	100,0	85	12,0		EU 190 210-1	210,0	190	16,0	
EU 85 100	100,0	85	13,0		EU 200 212-1	212,0	200	16,0	
EU 85 105	105,0	85	13,0		EU 200 220	220,0	200	13,0	
EU 85 105-1	105,0	85	14,5		EU 200 220-1	220,0	200	16,0	
EU 90 100-1	100,0	90	12,5		EU 207 217-S	217,0	207	15,0	
EU 90 105-2	105,0	90	9,5		EU 210 230	230,0	210	13,0	
EU 90 105-3	105,0	90	12,5	ISO 5597	EU 210 230-2	230,0	210	16,0	
EU 90 105	105,0	90	13,0		EU 210 235-1	235,0	210	26,0	
EU 90 110	110,0	90	13,0		EU 220 240	240,0	220	13,0	
EU 90 110-1	110,0	90	16,0	ISO 5597	EU 220 240-1	240,0	220	16,0	
EU 91 99-1	99,0	91	8,5		EU 230 250	250,0	230	13,0	
EU 93 104-1	104,0	93	11,0		EU 230 260	260,0	230	25,0	
EU 95 105-1	105,0	95	11,0		EU 231 241-S	241,0	231	15,0	
EU 95 115	115,0	95	13,0		EU 240 260	260,0	240	13,0	
EU 99 109-S	109,0	99	15,0		EU 240 260-1	260,0	240	16,0	
EU 100 110-1	110,0	100	15,0		EU 240 270	270,0	240	19,0	
EU 100 113-1	113,0	100	13,5		EU 250 270	270,0	250	13,0	
EU 100 115-2	115,0	100	11,5		EU 250 270-1	270,0	250	16,0	
EU 100 115	115,0	100	13,0		EU 280 305-1	305,0	280	16,0	
EU 100 120	120,0	100	13,0		EU 280 310	310,0	280	25,0	
EU 100 120-2	120,0	100	16,0	ISO 5597					

Web: <http://cat.hansa-flex.com/en/EU>

## EU-I

## Rod seal EU-I



Spaltmaß / Clearance	s (mm) EU - EU-I	
Druck bar	d < 68 mm	d > 68 mm
50	≤ 0,40	≤ 0,50
100	≤ 0,30	≤ 0,40
200	≤ 0,20	≤ 0,30
300	≤ 0,15	≤ 0,20
400	≤ 0,10	≤ 0,15

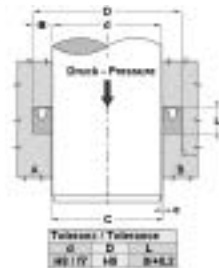

Low-friction seal. High abrasion resistance. Simple solution.

**Design:** Rod lip seal**Operating pressure:** up to 400 bar**Sliding speed max.:** 0,5 m/s**Design:** Inches**Temp. min.:** -30 °C**Temp. max.:** 80 °C**Media:** Mineral oils**Installation:** in closed grooves in open grooves**Material:** PUR**Application:** Hydraulics**Ordering information:** We are able to produce EU seals with diameters of 20 to 510 mm with short lead times.

Identification	D	d	L	Identification	D	d	L
	mm	mm	mm		mm	mm	mm
EU-I 100 125	31,75	25,40	7,0	EU-I 200 250	63,50	50,80	10,5
EU-I 125 162	41,22	31,75	8,7	EU-I 225 262	66,67	57,15	10,5
EU-I 150 187	47,62	38,10	8,7	EU-I 225 275	69,85	57,15	10,5

(Continued)

EU-I

Rod seal EU-I

Identification	D mm	d mm	L mm
EU-I 237 287	73,03	60,33	10,3
EU-I 250 300	76,20	63,50	10,5
EU-I 275 325	82,55	69,85	10,5
EU-I 300 350	88,90	76,20	10,5

Identification	D mm	d mm	L mm
EU-I 325 375	95,25	82,55	10,5
EU-I 350 400	101,60	88,90	10,5
EU-I 400 462	117,47	101,60	10,5

Web: <http://cat.hansa-flex.com/en/EUI>

EUS-I

Rod seal EUS-I

Extremely good sealing effect at low pressure. High abrasion resistance. Simple solution.

**Design:** rod seal

**Operating pressure:** up to 400 bar

**Sliding speed max.:** 0,5 m/s

**Temp. min.:** -30 °C

**Temp. max.:** 80 °C

**Media:** Mineral oils

**Installation:** in closed grooves A, in open grooves B

**Material:** (1) Pre-load ring: NBR, (2) Seal: PUR

**Application:** Hydraulics

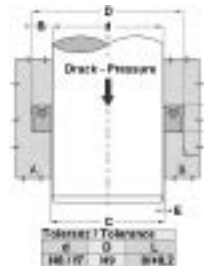

Druck bar	Spaltmaß / Clearance E (mm)	
	d < 60 mm	d > 60 mm
50	< 0,40	< 0,50
100	< 0,50	< 0,60
200	= 0,20	= 0,30
300	= 0,15	= 0,20
400	< 0,10	< 0,15

**Ordering information:** We are able to produce EUS-I seals with diameters of 20 to 510 mm with short lead times.

Identification	d mm	D mm	L mm	Identification	d mm	D mm	L mm
EUS-I 025 050	6,35	12,70	3,5	EUS-I 212 250-1	53,97	63,50	10,5
EUS-I 050 075	12,70	19,05	3,5	EUS-I 225 262-2	57,15	66,67	5,3
EUS-I 050 100	12,70	25,40	10,5	EUS-I 225 262	57,15	66,67	8,7
EUS-I 075 100-2	19,05	25,40	3,5	EUS-I 225 262-1	57,15	66,67	10,5
EUS-I 075 100	19,05	25,40	5,3	EUS-I 225 275	57,15	69,85	10,5
EUS-I 075 100-1	19,05	25,40	7,0	EUS-I 250 287	63,50	73,02	8,7
EUS-I 087 112	22,22	28,57	7,0	EUS-I 250 287-1	63,50	73,02	10,5
EUS-I 100 125	25,40	31,75	5,3	EUS-I 250 300	63,50	76,20	7,0
EUS-I 100 137	25,40	34,93	8,7	EUS-I 250 300-1	63,50	76,20	10,5
EUS-I 112 137	28,57	34,93	3,5	EUS-I 250 312	63,50	79,37	14,0
EUS-I 112 150	28,57	38,10	8,7	EUS-I 262 300	66,67	76,20	5,3
EUS-I 125 150	31,75	38,10	5,3	EUS-I 262 300-1	66,67	76,20	10,5
EUS-I 125 150-1	31,75	38,10	7,0	EUS-I 275 325	69,85	82,55	10,5
EUS-I 125 162	31,75	41,27	7,0	EUS-I 275 350	69,85	88,90	10,5
EUS-I 125 162-1	31,75	41,27	8,7	EUS-I 275 350-1	69,85	88,90	17,5
EUS-I 125 175	31,75	44,45	5,3	EUS-I 287 337	73,02	85,72	10,5
EUS-I 125 187	31,75	47,62	8,7	EUS-I 287 350	73,02	88,90	14,0
EUS-I 125 187-1	31,75	47,62	10,5	EUS-I 300 337-1	76,20	85,72	10,5
EUS-I 125 200	31,75	50,80	10,5	EUS-I 300 350	76,20	88,90	10,5
EUS-I 137 162	34,92	41,27	5,3	EUS-I 300 362	76,20	92,07	10,5
EUS-I 137 175	34,92	44,45	8,7	EUS-I 300 362-1	76,20	92,07	14,0
EUS-I 150 187	38,10	47,62	7,0	EUS-I 300 375	76,20	95,25	17,5
EUS-I 162 200	41,27	50,80	10,5	EUS-I 312 350	79,37	88,90	10,5
EUS-I 175 212	44,45	53,97	7,0	EUS-I 312 362	79,37	92,07	10,5
EUS-I 175 212-2	44,45	53,97	8,7	EUS-I 325 375	82,55	95,25	10,5
EUS-I 175 212-1	44,45	53,97	10,5	EUS-I 325 375-1	82,55	95,25	14,0
EUS-I 175 225	44,45	57,15	10,5	EUS-I 325 400	82,55	101,60	14,0
EUS-I 175 237	44,45	60,32	14,0	EUS-I 350 400	88,90	101,60	10,5
EUS-I 187 225	47,62	57,15	5,3	EUS-I 350 450	88,90	114,30	21,0
EUS-I 187 225-1	47,62	57,15	10,5	EUS-I 375 425	95,25	107,95	10,5
EUS-I 187 237	47,62	60,32	10,5	EUS-I 375 425-1	95,25	107,95	15,7
EUS-I 187 250	47,62	63,50	10,5	EUS-I 375 450	95,25	114,30	14,0
EUS-I 200 237	50,80	60,32	8,7	EUS-I 400 450	101,60	114,30	10,5
EUS-I 200 237-1	50,80	60,32	10,5	EUS-I 400 450-1	101,60	114,30	15,7
EUS-I 200 250	50,80	63,50	10,5	EUS-I 500 550	127,00	139,70	10,5
EUS-I 212 250	53,97	63,50	7,0	EUS-I 550 625	139,70	158,75	17,5

Web: <http://cat.hansa-flex.com/en/EUSI>

**IBU**

**Rod seal, IBU**

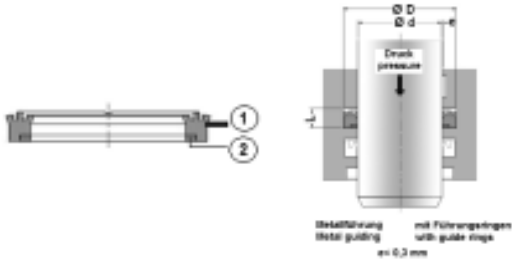

As buffer seal. Easy assembly. Easy installation space at the same time small dimensions. High abrasion resistance. Good extrusion resistance. High temperature resistance.

- Design:** rod seal
- Operating pressure:** up to 500 bar
- Sliding speed max.:** 0,5 m/s
- Temp. min.:** -40 °C
- Temp. max.:** 100 °C
- Colour:** blue / brown
- Material:** (1) seal: PU10, (2) Support ring: POM

**Note:** Gap e up to max 0,3 mm

Identification	D mm	d mm	L mm
IBU 60	75	60	9,5
IBU 65	80	65	9,5
IBU 70	85	70	9,5

Identification	D mm	d mm	L mm
IBU 75	90	75	9,5
IBU 80	95	80	9,5
IBU 90	105	90	9,5

**Web:** <http://cat.hansa-flex.com/en/IBU>

**IBF**

**Rod seal IBF**

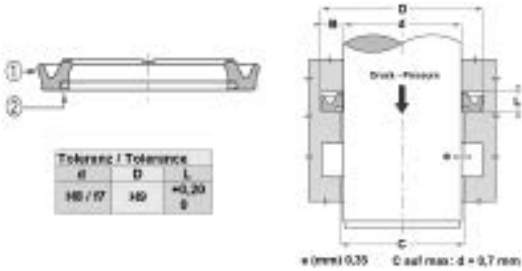

Low spatial requirement. High abrasion resistance. As buffer seal.

- Design:** Rod U-ring
- Operating pressure:** up to 400 bar
- Sliding speed max.:** 0,5 m/s
- Temp. min.:** -30 °C
- Temp. max.:** 80 °C
- Media:** Mineral oils
- Installation:** in closed grooves
- Application:** Hydraulics
- Material:** (2) Seal: PUR, Support ring: POM

Identification	D mm	d mm	L mm
IBF 40	55,5	40	6,3
IBF 50	65,5	50	6,3
IBF 55	70,5	55	6,3
IBF 60	75,5	60	6,3
IBF 65	80,5	65	6,3
IBF 70	85,5	70	6,3

Identification	D mm	d mm	L mm
IBF 75	90,5	75	6,3
IBF 80	95,5	80	6,3
IBF 85	100,5	85	6,3
IBF 95	110,5	95	6,3
IBF 100	115,5	100	6,3

**Web:** <http://cat.hansa-flex.com/en/IBF>

**IGR B**

**Rod seal IGR-B**

Low spatial requirement. High extrusion resistance. low break-loose torque and dynamic friction Long service life.

- Design:** Rod packing set
- Operating pressure:** up to 700 bar
- Sliding speed max.:** 15,0 m/s
- Temp. min.:** -30 °C
- Temp. max.:** 110 °C
- Media:** Mineral oils, Water emulsions
- Installation:** first bend the O-ring and then the PTFE ring into a kidney shape, and press into the locating groove (from 30 mm).
- Material:** (1) Dynamic seal: PTBR, (2) Static seal: NBR
- Application:** Hydraulics

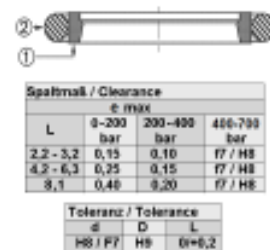
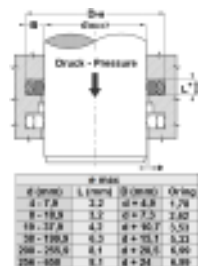

**Ordering information:** We are able to produce GR/IGRL seals with diameters 20 to 510 mm with short lead times. Dimensions can be calculated from table 44.1.

Identification	d mm	D mm	L mm	Identification	d mm	D mm	L mm
IGR 0050 B 554470	5	9,9	2,2	IGR 0630 B 554470	63	78,1	6,3
IGR 0080 B 554470	8	15,3	3,2	IGR 0650 B 554470	65	80,1	6,3
IGR 0100 B 554470	10	17,3	3,2	IGR 0700 B 554470	70	85,1	6,3
IGR 0120 B 554470	12	19,3	3,2	IGR 0750 B 554470	75	90,1	6,3
IGR 0140 B 554470	14	21,3	3,2	IGR 0800 B 554470	80	95,1	6,3
IGR 0150 B 554470	15	22,3	3,2	IGR 0850 B 554470	85	100,1	6,3
IGR 0160 B 554470	16	23,3	3,2	IGR 0900 B 554470	90	105,1	6,3
IGR 0180 B 554470	18	25,3	3,2	IGR 0950 B 554470	95	110,1	6,3
IGR 0200 B 554470	20	30,7	4,2	IGR 1000 B 554470	100	115,1	6,3
IGR 0220 B 554470	22	32,7	4,2	IGR 1050 B 554470	105	120,1	6,3
IGR 0240 B 554470	24	34,7	4,2	IGR 1100 B 554470	110	125,1	6,3
IGR 0250 B 554470	25	35,7	4,2	IGR 1150 B 554470	115	130,1	6,3
IGR 0280 B 554470	28	38,7	4,2	IGR 1200 B 554470	120	135,1	6,3
IGR 0300 B 554470	30	40,7	4,2	IGR 1250 B 554470	125	140,1	6,3
IGR 0320 B 554470	32	42,7	4,2	IGR 1300 B 554470	130	145,1	6,3
IGR 0350 B 554470	35	45,7	4,2	IGR 1400 B 554470	140	155,1	6,3
IGR 0360 B 554470	36	46,7	4,2	IGR 1500 B 554470	150	165,1	6,3
IGR 0370 B 554470	37	47,7	4,2	IGR 1600 B 554470	160	175,1	6,3
IGR 0380 B 554470	38	53,1	6,3	IGR 1700 B 554470	170	185,1	6,3
IGR 0400 B 554470	40	55,1	6,3	IGR 1800 B 554470	180	195,1	6,3
IGR 0420 B 554470	42	57,1	6,3	IGR 1900 B 554470	190	205,1	6,3
IGR 0450 B 554470	45	60,1	6,3	IGR 2000 B 554470	200	220,5	8,1
IGR 0480 B 554470	48	63,1	6,3	IGR 2200 B 554470	220	240,5	8,1
IGR 0500 B 554470	50	65,1	6,3	IGR 2500 B 554470	250	270,5	8,1
IGR 0550 B 554470	55	70,1	6,3	IGR 2800 B 554470	280	304,0	8,1
IGR 0560 B 554470	56	71,1	6,3	IGR 3600 B 554470	360	384,0	8,1
IGR 0600 B 554470	60	75,1	6,3				

**Web:** <http://cat.hansa-flex.com/en/IGRB>

**IGR BPU**

**Rod seal, IGR-BPU**

Low spatial requirement. High abrasion resistance. High extrusion resistance. Very good sealing effect at low or high pressure. Long service life.

- Operating pressure:** up to 280 bar (PU30)
- Sliding speed max.:** 2,0 m/s
- Temp. min.:** -30 °C
- Temp. max.:** 110 °C
- Media:** Mineral oils
- Installation:** first bend the O-ring and then the PTFE ring into a kidney shape, and press into the locating groove (from 30 mm).
- Material:** (1) Dynamic seal: H-PU D55, (2) Static seal: NBR
- Application:** Hydraulics

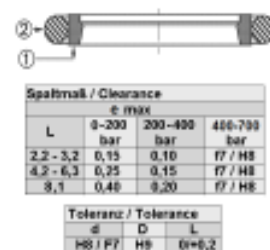
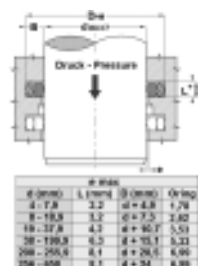

**Ordering information:** We are able to produce IGR...PUR / IGRL...PUR seals with diameters 20 to 510 mm with short lead times. Dimensions can be calculated from table 46.1. Alternative materials possible: PUR.

Identification	d mm	D mm	L mm
K-DIGR 0200 BPU 30 447	20	30,7	4,2
K-DIGR 0220 BPU 30 447	22	32,7	4,2
K-DIGR 0250 BPU 30 447	25	35,7	4,2
K-DIGR 0280 BPU 30 447	28	38,7	4,2
K-DIGR 0300 BPU 30 447	30	40,7	4,2
K-DIGR 0320 BPU 30 447	32	42,7	4,2
K-DIGR 0350 BPU 30 447	35	45,7	4,2
K-DIGR 0360 BPU 30 447	36	46,7	4,2
K-DIGR 0400 BPU 30 447	40	55,1	6,3
K-DIGR 0420 BPU 30 447	42	57,1	6,3
K-DIGR 0450 BPU 30 447	45	60,1	6,3
K-DIGR 0500 BPU 30 447	50	65,1	6,3

**IGR BPU**

(Continued)

**Rod seal, IGR-BPU**

Identification	d mm	D mm	L mm
K-DIGR 0550 BPU 30 447	55	70,1	6,3
K-DIGR 0560 BPU 30 447	56	71,1	6,3
K-DIGR 0600 BPU 30 447	60	75,1	6,3
K-DIGR 0650 BPU 30 447	65	80,1	6,3
K-DIGR 0700 BPU 30 447	70	85,1	6,3
K-DIGR 0750 BPU 30 447	75	90,1	6,3
K-DIGR 0800 BPU 30 447	80	95,1	6,3
K-DIGR 0850 BPU 30 447	85	100,1	6,3
K-DIGR 0900 BPU 30 447	90	105,1	6,3
K-DIGR 0950 BPU 30 447	95	110,1	6,3
K-DIGR 1050 BPU 30 447	105	120,1	6,3
K-DIGR 1100 BPU 30 447	110	125,1	6,3
K-DIGR 1400 BPU 30 447	140	155,1	6,3
K-DIGR 1500 BPU 30 447	150	165,1	6,3
K-DIGR 2000 BPU 30 447	200	220,5	8,1

Web: <http://cat.hansa-flex.com/en/IGRBPU>

**IGRL B**

**Rod seal IGRL-B**

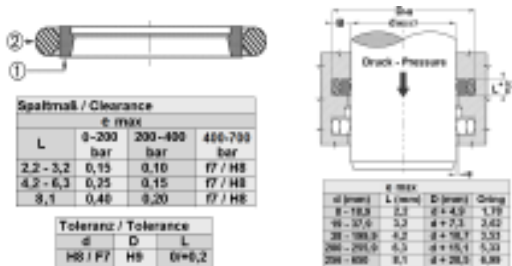

Low spatial requirement. High extrusion resistance. low break-loose torque and dynamic friction Long service life.

- Design:** Rod packing set
- Operating pressure:** up to 700 bar
- Sliding speed max.:** 15,0 m/s
- Temp. min.:** -30 °C
- Temp. max.:** 110 °C
- Media:** Mineral oils, Water emulsions
- Installation:** first bend the O-ring and then the PTFE ring into a kidney shape, and press into the locating groove (from 30 mm).
- Material:** (1) Dynamic seal: PTBR, (2) Static seal: NBR
- Application:** Hydraulics

**Ordering information:** We are able to produce GR/IGRL seals with diameters 20 to 510 mm with short lead times. Dimensions can be calculated from table 44.1.

Identification	d mm	D mm	L mm	Identification	d mm	D mm	L mm
IGRL 0200 B 554470	20	27,3	3,2	IGRL 0550 B 554470	55	65,7	4,2
IGRL 0220 B 554470	22	29,3	3,2	IGRL 0560 B 554470	56	66,7	4,2
IGRL 0250 B 554470	25	32,3	3,2	IGRL 0600 B 554470	60	70,7	4,2
IGRL 0280 B 554470	28	35,3	3,2	IGRL 0650 B 554470	65	75,7	4,2
IGRL 0300 B 554470	30	37,3	3,2	IGRL 0700 B 554470	70	80,7	4,2
IGRL 0350 B 554470	35	42,3	3,2	IGRL 0800 B 554470	80	90,7	4,2
IGRL 0360 B 554470	36	43,3	3,2	IGRL 0900 B 554470	90	100,7	4,2
IGRL 0400 B 554470	40	50,7	4,2	IGRL 1000 B 554470	100	110,7	4,2
IGRL 0450 B 554470	45	55,7	4,2	IGRL 1300 B 554470	130	140,7	4,2
IGRL 0500 B 554470	50	60,7	4,2				

Web: <http://cat.hansa-flex.com/en/IGRLB>

## IGRL BPU

## Rod seal, IGRL-BPU

Low spatial requirement. High abrasion resistance. High extrusion resistance. Very good sealing effect at low or high pressure. Long service life.

**Design:** rod seal

**Operating pressure:** up to 280 bar (PU30)

**Sliding speed max.:** 2,0 m/s

**Design:** light

**Temp. min.:** -30 °C

**Temp. max.:** 110 °C

**Media:** Mineral oils

**Installation:** first bend the O-ring and then the PTFE ring into a kidney shape, and press into the locating groove (from 30 mm).

**Material:** Dynamic seal: PTFE, (2) Static seal: NBR

**Application:** Hydraulics

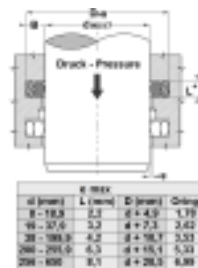

L	Spaltmaß / Clearance		
	E max		
	0-200	200-400	400-700
	bar	bar	bar
2,2 - 3,2	0,15	0,10	F7 / H8
4,5 - 6,3	0,25	0,15	F7 / H8
9,1	0,40	0,20	F7 / H8

Toleranz / Tolerance		
d	D	L
H8 / F7	H8	0/+0,2

**Ordering information:** We are able to produce IGR...PUR / IGRL...PUR seals with diameters 20 to 510 mm with short lead times. Dimensions can be calculated from table 46.1. Alternative materials possible: PUR.

Identification	d mm	D mm	L mm
K-DIGRL 0200 BPU 3044	20,0	27,3	3,2
K-DIGRL 0220 BPU 3044	22,0	29,3	3,2
K-DIGRL 0250 BPU 3044	25,0	32,3	3,2
K-DIGRL 0280 BPU 3044	28,0	35,3	3,2
K-DIGRL 0300 BPU 3044	30,0	37,3	3,2
K-DIGRL 0350 BPU 3044	35,0	42,3	3,2
K-DIGRL 0360 BPU 3044	36,0	43,3	3,2
K-DIGRL 0400 BPU 3044	40,0	50,7	4,2
K-DIGRL 0450 BPU 3044	45,0	55,7	4,2
K-DIGRL 0500 BPU 3044	50,0	60,7	4,2
K-DIGRL 0550 BPU 3044	55,0	65,7	4,2
K-DIGRL 0560 BPU 3044	56,0	66,7	4,2
K-DIGRL 0600 BPU 3044	60,0	70,7	4,2

BD = Working pressure

**Web:** <http://cat.hansa-flex.com/en/IGRLBPU>

# MU

## U-ring MU

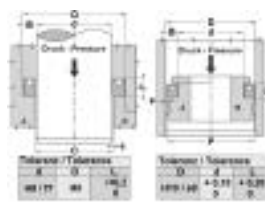
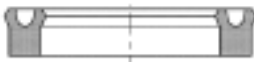

Spaltmaß / Clearance		
Druck / bar	e (mm)	
	d < 60 mm	d ≥ 60 mm
50	< 0,40	< 0,50
100	< 0,30	> 0,60
200	< 0,20	> 0,50
300	< 0,15	> 0,20
400	< 0,10	> 0,15

For rods and pistons. High abrasion resistance. Use for new designs TS, TS-L, RS-L and EU profiles (rod seals).

- Design:** U-ring
- Operating pressure:** up to 400 bar
- Sliding speed max.:** 0,5 m/s
- Temp. min.:** -30 °C
- Temp. max.:** 80 °C
- Media:** Mineral oils
- Installation:** in closed grooves A, in open grooves B, on a B or multi-part A piston
- Material:** PUR
- Application:** Hydraulics

**Ordering information:** We are able to produce seals with diameters of 20 to 510 mm with short lead times.

Identification	d mm	D mm	L mm	Identification	d mm	D mm	L mm
MU 09 03	3,00	9,0	5,0	MU 26 18-1	18,00	26,0	4,5
MU 10 04	4,00	10,0	4,5	MU 26 18	18,00	26,0	7,5
MU 10 04-1	4,00	10,0	5,0	MU 26 18-4	18,00	26,0	9,0
MU 11 04	4,50	11,0	5,5	MU 27 15	15,00	27,0	7,0
MU 12 04	4,00	12,0	4,5	MU 28 15	15,00	28,0	11,0
MU 12 05-1	5,00	12,0	5,5	MU 28 16	16,00	28,0	7,0
MU 12 05-2	5,00	12,0	6,5	MU 28 18	18,00	28,0	5,5
MU 12 05	5,00	12,0	7,0	MU 28 18-1	18,00	28,0	9,0
MU 12 06	6,00	12,0	4,5	MU 28 20	20,00	28,0	5,0
MU 12 06-4	6,00	12,0	6,0	MU 28 20-1	20,00	28,0	5,5
MU 12 06-5	6,00	12,0	6,5	MU 28 20-3	20,00	28,0	9,0
MU 12 06-2	6,00	12,0	9,0	MU 28 22	22,00	28,0	9,0
MU 12 08	8,00	12,0	3,5	MU 30 18-1	18,00	30,0	9,0
MU 13 06	6,00	12,7	6,5	MU 30 20-1	20,00	30,0	5,5
MU 13 05	5,00	13,0	4,5	MU 30 20-3	20,00	30,0	8,0
MU 14 07	7,00	14,0	4,2	MU 30 20-2	20,00	30,0	9,0
MU 14 08	8,00	14,0	7,0	MU 30 20	20,00	30,0	11,0
MU 15 06	6,00	15,0	9,0	MU 30 22-1	22,00	30,0	4,5
MU 15 07-1	7,00	15,0	8,0	MU 30 22-2	22,00	30,0	7,0
MU 15 08	8,00	15,0	6,3	MU 30 22	22,00	30,0	7,5
MU 15 08-2	8,00	15,0	9,0	MU 30 22-3	22,00	30,0	11,0
MU 15 09	9,00	15,0	9,0	MU 30 23	23,00	30,0	7,5
MU 16 06	6,00	16,0	5,5	MU 32 16	16,00	32,0	9,0
MU 16 08	8,00	16,0	4,5	MU 32 20-2	20,00	32,0	8,5
MU 16 08-2	8,00	16,0	6,3	MU 32 20-1	20,00	32,0	10,0
MU 16 10	10,00	16,0	6,5	MU 32 22-1	22,00	32,0	5,5
MU 18 08	8,00	18,0	5,5	MU 32 22	22,00	32,0	9,0
MU 18 08-1	8,00	18,0	8,0	MU 32 22-2	22,00	32,0	11,0
MU 18 08-2	8,00	18,0	11,0	MU 32 24-3	24,00	32,0	6,5
MU 18 10-3	10,00	18,0	4,5	MU 32 24-1	24,00	32,0	7,5
MU 18 10-1	10,00	18,0	6,0	MU 32 24-4	24,00	32,0	8,0
MU 18 10	10,00	18,0	7,0	MU 33 25-1	25,00	33,0	4,5
MU 18 10-4	10,00	18,0	9,0	MU 33 25-2	25,00	33,0	5,5
MU 18 12	12,00	18,0	5,5	MU 33 25	25,00	33,0	7,5
MU 18 12-1	12,00	18,0	7,0	MU 34 22	22,00	34,0	6,5
MU 19 09-1	9,00	19,0	7,0	MU 34 26	26,00	34,0	4,5
MU 20 10	10,00	20,0	5,5	MU 35 20	20,00	35,0	13,0
MU 20 10-1	10,00	20,0	9,0	MU 35 22-1	22,00	35,0	6,0
MU 20 12-1	12,00	20,0	4,5	MU 35 22	22,00	35,0	11,0
MU 20 12-2	12,00	20,0	8,0	MU 35 25-1	25,00	35,0	5,5
MU 20 12	12,00	20,0	9,0	MU 35 25-2	25,00	35,0	9,0
MU 20 14	14,00	20,0	5,3	MU 35 25	25,00	35,0	11,0
MU 21 11	11,00	20,5	7,0	MU 35 27	27,00	35,0	6,5
MU 22 08	8,00	22,0	9,0	MU 35 28	28,00	35,0	5,5
MU 22 10	10,00	22,0	7,0	MU 36 22	22,00	36,0	11,0
MU 22 10-1	10,00	22,0	9,0	MU 36 24	24,00	36,0	6,5
MU 22 12	12,00	22,0	5,5	MU 36 26-1	26,00	36,0	8,0
MU 22 12-4	12,00	22,0	8,0	MU 36 28	28,00	36,0	7,5
MU 22 12-1	12,00	22,0	9,0	MU 37 30	30,00	37,0	7,0
MU 22 14-1	14,00	22,0	7,0	MU 38 25	25,00	38,0	9,0
MU 22 14-2	14,00	22,0	9,0	MU 38 25-2	25,00	38,0	11,0
MU 22 16	16,00	22,0	4,5	MU 38 28-1	28,00	38,0	9,0
MU 22 16-2	16,00	22,0	5,5	MU 38 30	30,00	38,0	8,0
MU 24 12-1	12,00	24,0	9,0	MU 38 30-2	30,00	38,0	6,5
MU 24 14	14,00	24,0	9,0	MU 38 25-1	25,00	38,1	7,0
MU 24 16-1	16,00	24,0	4,5	MU 39 20	20,00	39,0	11,0
MU 24 16-2	16,00	24,0	6,0	MU 40 20-1	20,00	40,0	11,0
MU 24 16-3	16,00	24,0	9,0	MU 40 20	20,00	40,0	12,0
MU 24 16	16,00	24,0	10,0	MU 40 20-2	20,00	40,0	13,0
MU 25 10	10,00	25,0	8,0	MU 40 22	22,00	40,0	11,0
MU 25 12-1	12,00	25,0	9,0	MU 40 24	24,00	40,0	9,0
MU 25 15-1	15,00	25,0	5,5	MU 40 25	25,00	40,0	8,0
MU 25 15-2	15,00	25,0	9,0	MU 40 25-1	25,00	40,0	11,0
MU 25 15	15,00	25,0	11,0	MU 40 28	28,00	40,0	6,5
MU 25 16-1	16,00	25,0	9,0	MU 40 28-1	28,00	40,0	11,0
MU 25 17-2	17,00	25,0	11,0	MU 40 30-1	30,00	40,0	5,5
MU 25 18	18,00	25,0	5,5	MU 40 30	30,00	40,0	11,0
MU 25 19-1	19,00	25,0	3,5	MU 40 32-1	32,00	40,0	4,5
MU 25 19	19,00	25,0	7,0	MU 40 32	32,00	40,0	6,0
MU 25 16	15,90	25,4	7,0	MU 40 32-3	32,00	40,0	9,0
MU 26 16	16,00	26,0	6,0	MU 42 30-1	30,00	42,0	6,5
MU 26 16-1	16,00	26,0	9,0	MU 42 30	30,00	42,0	10,0
MU 26 16-2	16,00	26,0	11,0	MU 42 30-2	30,00	42,0	11,0



(Continued)

MU

U-ring MU

Identification	d mm	D mm	L mm	Identification	d mm	D mm	L mm
MU 42 32-1	32,00	42,0	5,5	MU 75 55-1	55,00	75,0	13,0
MU 42 32-2	32,00	42,0	8,0	MU 75 60-1	60,00	75,0	8,0
MU 42 32	32,00	42,0	11,0	MU 75 60-2	60,00	75,0	11,0
MU 42 34	34,00	42,0	6,5	MU 75 60	60,00	75,0	13,0
MU 45 25	25,00	45,0	11,0	MU 75 63	63,00	75,0	11,0
MU 45 30	30,00	45,0	10,0	MU 75 65	85,00	75,0	13,0
MU 45 30-1	30,00	45,0	11,0	MU 76 56	56,00	76,0	13,0
MU 45 32	32,00	45,0	11,0	MU 76 66	66,00	76,0	9,0
MU 45 34-1	34,00	45,0	8,0	MU 78 63	63,00	78,0	11,0
MU 45 34	34,00	45,0	10,0	MU 80 50	50,00	80,0	11,0
MU 45 35	35,00	45,0	5,5	MU 80 55-3	55,00	80,0	11,0
MU 45 35-2	35,00	45,0	9,0	MU 80 55	55,00	80,0	13,0
MU 45 35-3	35,00	45,0	11,0	MU 80 55-1	55,00	80,0	20,0
MU 45 38	38,00	45,0	5,5	MU 80 60	60,00	80,0	11,0
MU 46 36	36,00	46,0	8,0	MU 80 60-1	60,00	80,0	13,0
MU 46 38	38,00	46,0	7,5	MU 80 60-2	60,00	80,0	16,0
MU 48 35	35,00	48,0	11,0	MU 80 60-3	60,00	80,0	19,0
MU 48 36	36,00	48,0	9,0	MU 80 65-1	65,00	80,0	8,0
MU 48 40-1	40,00	48,0	12,0	MU 80 65-3	65,00	80,0	11,0
MU 50 30	30,00	50,0	11,0	MU 80 65-2	65,00	80,0	12,0
MU 50 30-1	30,00	50,0	13,0	MU 80 65	65,00	80,0	13,0
MU 50 32-1	32,00	50,0	13,0	MU 80 66	66,00	80,0	11,0
MU 50 34-1	34,00	50,0	15,0	MU 80 70-2	70,00	80,0	5,5
MU 50 35	35,00	50,0	8,0	MU 80 70	70,00	80,0	9,0
MU 50 35-1	35,00	50,0	11,0	MU 80 70-3	70,00	80,0	11,0
MU 50 38	38,00	50,0	6,5	MU 80 70-1	70,00	80,0	13,0
MU 50 38-1	38,00	50,0	10,0	MU 83 63	63,00	83,0	16,0
MU 50 40-2	40,00	50,0	5,5	MU 85 55	55,00	85,0	16,0
MU 50 40	40,00	50,0	7,5	MU 85 60-2	60,00	85,0	11,0
MU 50 40-3	40,00	50,0	9,0	MU 85 65-1	65,00	85,0	11,0
MU 50 40-1	40,00	50,0	11,0	MU 85 65	65,00	85,0	13,0
MU 50 44	44,00	50,0	9,5	MU 85 70	70,00	85,0	11,0
MU 51 41	40,80	50,8	7,7	MU 85 70-1	70,00	85,0	12,0
MU 52 32	32,00	52,0	11,0	MU 85 70-2	70,00	85,0	13,0
MU 52 40	40,00	52,0	9,0	MU 85 75	75,00	85,0	13,0
MU 52 40-2	40,00	52,0	11,0	MU 90 60	60,00	90,0	16,0
MU 52 42-1	42,00	52,0	10,0	MU 90 70-1	70,00	90,0	11,0
MU 53 45	45,00	53,0	7,5	MU 90 70	70,00	90,0	13,0
MU 54 42	42,00	54,0	6,5	MU 90 70-2	70,00	90,0	16,0
MU 55 35	35,00	55,0	11,0	MU 90 70-3	70,00	90,0	19,0
MU 55 35-1	35,00	55,0	13,0	MU 90 75-1	75,00	90,0	8,5
MU 55 38	38,00	55,0	11,0	MU 90 75	75,00	90,0	11,0
MU 55 40	40,00	55,0	11,0	MU 90 75-2	75,00	90,0	13,0
MU 55 45	45,00	55,0	7,5	MU 90 80	80,00	90,0	5,5
MU 55 45-3	45,00	55,0	9,0	MU 90 80-2	80,00	90,0	11,0
MU 55 45-1	45,00	55,0	11,0	MU 90 80-3	80,00	90,0	13,0
MU 56 40	40,00	56,0	11,0	MU 93 78	78,00	93,0	11,5
MU 58 38	38,00	58,0	11,0	MU 95 70-2	70,00	95,0	11,0
MU 58 48	48,00	58,0	11,0	MU 95 70	70,00	95,0	13,0
MU 60 35	35,00	60,0	13,0	MU 95 75-3	75,00	95,0	11,0
MU 60 40-1	40,00	60,0	11,0	MU 95 75-1	75,00	95,0	13,0
MU 60 40-2	40,00	60,0	14,0	MU 95 75	75,00	95,0	14,5
MU 60 40-3	40,00	60,0	19,0	MU 95 80	80,00	95,0	8,0
MU 60 45	45,00	60,0	11,0	MU 95 80-2	80,00	95,0	11,0
MU 60 48	48,00	60,0	6,5	MU 95 80-1	80,00	95,0	13,0
MU 60 50-2	50,00	60,0	5,5	MU 95 85-1	85,00	95,0	5,5
MU 60 50	50,00	60,0	11,0	MU 95 85	85,00	95,0	9,5
MU 60 50-1	50,00	60,0	12,0	MU 95 85-3	85,00	95,0	13,0
MU 62 42	42,00	62,0	13,0	MU 96 76	76,50	96,5	13,0
MU 62 50	50,00	62,0	10,0	MU 100 70	70,00	100,0	16,0
MU 62 52	52,00	62,0	13,0	MU 100 75	75,00	100,0	13,0
MU 63 45	45,00	63,0	11,0	MU 100 75-1	75,00	100,0	20,0
MU 63 48	48,00	63,0	11,0	MU 100 80-1	80,00	100,0	11,0
MU 63 50	50,00	63,0	7,0	MU 100 80	80,00	100,0	13,0
MU 63 53-1	53,00	63,0	5,5	MU 100 85-3	85,00	100,0	10,0
MU 63 53	53,00	63,0	7,5	MU 100 85-2	85,00	100,0	12,0
MU 63 53-2	53,00	63,0	8,0	MU 100 85	85,00	100,0	13,0
MU 65 40	40,00	65,0	13,0	MU 100 90-2	90,00	100,0	5,5
MU 65 45	45,00	65,0	11,0	MU 100 90-4	90,00	100,0	8,0
MU 65 45-1	45,00	65,0	13,0	MU 100 90	90,00	100,0	9,0
MU 65 50-1	50,00	65,0	11,0	MU 100 90-3	90,00	100,0	13,0
MU 65 55-1	55,00	65,0	11,0	MU 105 80-3	80,00	105,0	23,0
MU 65 55	55,00	65,0	13,0	MU 105 85-1	85,00	105,0	13,0
MU 70 36	26,00	70,0	11,0	MU 105 85-2	85,00	105,0	19,0
MU 70 40	40,00	70,0	16,0	MU 105 90-1	90,00	105,0	8,0
MU 70 50-1	50,00	70,0	11,0	MU 105 90	90,00	105,0	13,0
MU 70 50	50,00	70,0	13,0	MU 110 80	80,00	110,0	16,0
MU 70 50-2	50,00	70,0	16,0	MU 110 85	85,00	110,0	13,0
MU 70 55-1	55,00	70,0	8,0	MU 110 90-1	90,00	110,0	11,0
MU 70 55	55,00	70,0	11,0	MU 110 90	90,00	110,0	13,0
MU 70 55-3	55,00	70,0	12,0	MU 110 90-3	90,00	110,0	19,0
MU 70 55-2	55,00	70,0	13,0	MU 110 95-1	95,00	110,0	13,0
MU 70 60-2	60,00	70,0	5,5	MU 110 95-2	95,00	110,0	16,0
MU 70 60	60,00	70,0	9,0	MU 110 100	100,00	110,0	5,5
MU 70 60-3	60,00	70,0	11,0	MU 112 095-1	95,00	112,0	12,0
MU 70 60-1	60,00	70,0	13,0	MU 115 085	85,00	115,0	16,0
MU 72 50	50,00	72,0	13,0	MU 115 090-2	90,00	115,0	16,0
MU 75 50	50,00	75,0	13,0	MU 115 095	95,00	115,0	13,0
MU 75 55	55,00	75,0	11,0	MU 115 095-3	95,00	115,0	19,0

Web: <http://cat.hansa-flex.com/en/MU>

## MU

(Continued)

## U-ring MU

Identification	d mm	D mm	L mm	Identification	d mm	D mm	L mm
MU 115 100	100,00	115,0	13,0	MU 140 125-2	125,00	140,0	16,0
MU 120 090	90,00	120,0	16,0	MU 145 125	125,00	145,0	16,0
MU 120 100-1	100,00	120,0	11,0	MU 145 125-1	125,00	145,0	19,0
MU 120 100	100,00	120,0	13,0	MU 150 130-1	1301,00	150,0	16,0
MU 120 100-3	100,00	120,0	19,0	MU 150 135-1	135,00	150,0	16,0
MU 120 105-3	105,00	120,0	9,0	MU 155 125	125,00	155,0	16,0
MU 120 105-1	105,00	120,0	12,0	MU 155 135	135,00	155,0	16,0
MU 120 105-2	105,00	120,0	16,0	MU 160 135-1	135,00	160,0	16,0
MU 125 100	100,00	125,0	13,0	MU 160 140	140,00	160,0	11,0
MU 125 100-1	100,00	125,0	16,0	MU 160 140-2	140,00	160,0	13,0
MU 125 105	105,00	125,0	13,0	MU 160 140-1	140,00	160,0	16,0
MU 125 105-2	105,00	125,0	16,0	MU 165 145	145,00	165,0	16,0
MU 125 110-1	110,00	125,0	13,0	MU 170 150-2	150,00	170,0	16,0
MU 125 110-2	110,00	125,0	16,0	MU 170 150-3	150,00	170,0	19,0
MU 126 115	115,00	126,0	16,0	MU 175 160	160,00	175,0	12,0
MU 130 100	100,00	130,0	13,0	MU 180 160	160,00	180,0	16,0
MU 130 110-2	110,00	130,0	11,0	MU 190 170	170,00	190,0	16,0
MU 130 110-1	110,00	130,0	13,0	MU 200 170-1	170,00	200,0	19,0
MU 130 110	110,00	130,0	16,0	MU 200 175-1	175,00	200,0	16,0
MU 130 110-3	110,00	130,0	19,0	MU 200 180	180,00	200,0	16,0
MU 130 120	120,00	130,0	15,0	MU 220 180-1	180,00	220,0	21,0
MU 135 115	115,00	135,0	16,0	MU 220 190	190,00	220,0	23,0
MU 135 120	120,00	135,0	16,0	MU 225 200-2	200,00	225,0	19,0
MU 140 115-1	115,00	140,0	16,0	MU 240 210	210,00	240,0	18,0
MU 140 120-1	120,00	140,0	11,0	MU 250 220	220,00	250,0	19,0
MU 140 120	120,00	140,0	13,0	MU 250 220-1	220,00	250,0	22,0
MU 140 120-2	120,00	140,0	16,0	MU 320 305	305,00	320,0	18,0
MU 140 125	125,00	140,0	12,0	MU 390 360	360,00	390,0	23,0

Web: <http://cat.hansa-flex.com/en/MU>

## Rod seal RS-L

Low-friction seal. High abrasion resistance. Simple solution. Suitable for telescopic cylinders.

**Design:** Rod U-ring  
**Operating pressure:** up to 400 bar  
**Sliding speed max.:** 0,5 m/s  
**Temp. min.:** -30 °C  
**Temp. max.:** 80 °C  
**Media:** Mineral oils  
**Installation:** in closed grooves in open installation spaces  
**Material:** (2) Seal: PUR  
**Application:** Hydraulics

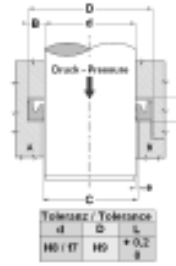

Druck bar	Spaltmaß / Clearance e (mm)			
	RS...-L d=10mm	RS...-L d=16mm	RS...-LA d=10mm	RS...-LA d=16mm
50	< 0,40	< 0,50	< 0,60	< 0,80
100	< 0,30	< 0,40	< 0,60	< 0,80
200	< 0,20	< 0,30	< 0,40	< 0,60
300	< 0,15	< 0,20	< 0,30	< 0,40
400	< 0,10	< 0,15	< 0,20	< 0,30
500		< 0,10	< 0,15	

**Ordering information:** We are able to produce seals with diameters of 20 to 510 mm with short lead times.

Identification	D mm	d mm	L mm	Standard grooves	Identification	D mm	d mm	L mm	Standard grooves
RS 15 26-L	26,0	15,0	8,0		RS 80 90-L2	90,0	80,0	12,5	
RS 18 26-L1	26,0	18,0	7,0		RS 80 95-L	95,0	80,0	12,5	ISO 5597
RS 25 33-L1	33,0	25,0	7,5		RS 82 97-L	97,5	82,5	13,0	
RS 25 33-L3	33,0	25,0	6,3		RS 85 93-L	83,0	85,0	12,5	
RS 25 35-L	25,0	25,0	8,0	ISO 5597	RS 87 95-L	95,0	87,0	12,5	
RS 28 38-L	38,0	28,0	8,5		RS 89 97-L	97,0	89,0	12,5	
RS 30 38-L	38,0	30,0	12,5		RS 90 98-L	98,0	90,0	12,5	
RS 30 40-L	40,0	30,0	8,0		RS 90 100-L1	100,0	90,0	10,0	
RS 32 40-L1	40,0	32,0	7,0		RS 90 100-L	100,0	90,0	12,5	
RS 32 40-L	40,0	32,0	7,7		RS 90 105-L	105,0	90,0	12,5	ISO 5597
RS 32 41-L	41,0	32,0	8,9		RS 90 110-L	110,0	90,0	13,0	
RS 35 43-L	43,0	35,0	8,0		RS 93 101-L	101,0	93,0	12,5	
RS 36 43-L	43,0	36,0	12,5		RS 95 103-L	103,0	95,0	12,5	
RS 36 44-L	44,0	36,0	7,0		RS 95 105-L1	105,0	95,0	9,5	
RS 38 46-L	46,0	38,0	12,5		RS 95 105-L	105,0	95,0	13,0	ISO 5597
RS 38 48-L	48,0	38,0	9,0		RS 97 105-L1	105,0	97,0	12,5	
RS 40 48-L1	48,0	40,0	6,3		RS 100 108-L	108,0	100,0	12,5	
RS 40 48-L	48,0	40,0	12,5		RS 100 110-L1	110,0	100,0	11,0	
RS 40 50-L	50,0	40,0	8,0	ISO 5597	RS 100 110-L	110,0	100,0	12,5	
RS 40 55-L	55,0	40,0	11,0		RS 1001 15-L	115,0	100,0	11,0	
RS 42 50-L	50,0	42,0	12,5		RS 100 115-L1	115,0	100,0	13,0	
RS 42 53-L	53,0	42,0	10,0		RS 100 120-L1	120,0	100,0	13,0	
RS 45 53-L	53,0	45,0	12,5		RS 105 113-L1	113,0	105,0	12,5	
RS 45 55-L	55,0	45,0	12,5		RS 105 113-L	113,0	105,0	14,5	
RS 48 56-L1	56,0	48,0	12,5		RS 105 115-L	115,0	105,0	12,5	
RS 50 57-L	57,0	50,0	11,0		RS 108 116-L	116,0	108,0	12,5	
RS 50 58-L	58,0	50,0	12,5		RS 110 118-L	118,0	110,0	12,5	
RS 50 60-L	60,0	50,0	8,0	ISO 5597	RS 113 123-L1	123,0	113,0	9,5	
RS 50 60-L1	60,0	50,0	11,0		RS 115 123-L	123,0	115,0	12,5	
RS 50 65-L1	65,0	50,0	11,0		RS 115 125-L1	125,0	115,0	13,0	
RS 50 65-L	65,0	50,0	16,5		RS 115 125-L	125,0	115,0	15,0	
RS 55 62-L	62,5	55,0	10,0		RS 120 128-L	128,0	120,0	12,5	
RS 55 63-L	63,0	55,0	12,5		RS 125 133-L	133,0	125,0	12,5	
RS 55 65-L1	65,0	55,0	9,5		RS 125 135-L	135,0	125,0	11,0	
RS 55 65-L	65,0	55,0	11,0		RS 125 145-L1	145,0	125,0	16,0	ISO 5597
RS 58 68-L	68,0	58,0	12,5		RS 128 136-L	136,0	128,0	12,5	
RS 60 68-L	68,0	60,0	12,5		RS 130 138-L	138,0	130,0	12,5	
RS 60 70-L	70,0	60,0	12,5		RS 132 142-L1	142,0	132,0	9,5	
RS 60 75-L1	75,0	60,0	11,0		RS 135 143-L	143,0	135,0	12,5	
RS 60 75-L2	75,0	60,0	12,5		RS 140 148-L	148,0	140,0	12,5	
RS 60 75-L	75,0	60,0	16,5		RS 143 151-L1	151,0	143,0	12,5	
RS 63 71-L	71,0	63,0	12,5		RS 145 153-L	153,0	145,0	12,5	
RS 65 73-L	73,0	65,0	12,5		RS 145 155-L	155,0	145,0	13,0	
RS 67 75-L	75,0	67,0	12,5		RS 150 170-L	170,0	150,0	16,0	
RS 70 78-L	78,0	70,0	12,5		RS 152 160-L	160,0	152,0	12,5	
RS 70 80-L	80,0	70,0	12,5		RS 155 163-L	163,0	155,0	12,5	
RS 70 85-L	85,0	70,0	12,5	ISO 5597	RS 160 168-L	168,0	160,0	12,5	
RS 70 90-L	90,0	70,0	13,0		RS 160 170-L	170,0	160,0	12,5	
RS 73 82-L	82,4	73,0	7,8		RS 170 178-L	178,0	170,0	12,5	
RS 75 83-L	83,0	75,0	12,5		RS 170 180-L	180,0	170,0	13,0	
RS 75 85-L1	85,0	75,0	9,5		RS 180 188-L	188,0	180,0	14,5	
RS 75 85-L	85,0	75,0	12,5		RS 180 190-L	190,0	180,0	11,0	
RS 78 86-L1	86,0	78,0	12,5		RS 180 195-L	195,0	180,0	13,5	
RS 78 90-L	90,0	78,0	13,0		RS 185 193-L	193,0	185,0	12,5	
RS 80 88-L	88,0	80,0	12,5		RS 202 212-L	212,0	202,0	14,5	
RS 80 90-L1	90,0	80,0	11,0		RS 212 220-L	212,0	212,0	14,5	

**Web:** <http://cat.hansa-flex.com/en/RS�>

## RS LA

### Rod seal RS-LA



Spaltmaß / Clearance Druck bar	e (mm)			
	RS...-L		RS...-LA	
50	< 0,40	< 0,50	< 0,60	< 0,80
100	< 0,30	< 0,40	< 0,50	< 0,80
200	< 0,20	< 0,30	< 0,40	< 0,60
300	< 0,15	< 0,20	< 0,30	< 0,40
400	< 0,10	< 0,15	< 0,20	< 0,30
500		< 0,10	< 0,15	

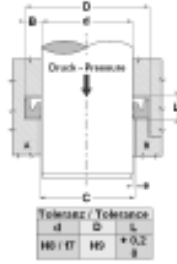

Low-friction seal. High abrasion resistance. Simple solution. Suitable for telescopic cylinders.

- Design:** Rod U-ring
- Operating pressure:** up to 500 bar
- Sliding speed max.:** 0,5 m/s
- Temp. min.:** -30 °C
- Temp. max.:** 80 °C
- Media:** Mineral oils
- Installation:** in closed grooves A, in open grooves B
- Material:** (1) Seal: PUR, (2) Support ring: acetal resin / PTBR
- Application:** Hydraulics

Identification	D mm	d mm	L mm	Standard grooves
RS 45 52-LA	52,0	45	14,0	
RS 50 60-LA	60,0	50	8,0	
RS 50 70-LA	70,0	50	13,0	
RS 60 68-LA	68,0	60	14,0	
RS 60 69-LA	69,0	60	11,0	
RS 60 80-LA	80,0	60	13,0	
RS 63 83-LA	83,0	63	13,0	
RS 70 85-LA	85,0	70	12,5	

Identification	D mm	d mm	L mm	Standard grooves
RS 78 86-LA	86,0	78	14,0	
RS 80 95-LA	95,0	80	12,5	ISO 5597
RS 97 105-LA	105,0	97	14,0	
RS 100 120-LA	120,0	100	14,5	
RS 118 126-LA	126,0	118	14,0	
RS 125 145-LA	145,0	125	13,0	
RS 143 151-LA	151,0	143	14,0	

**Web:** <http://cat.hansa-flex.com/en/RSLA>

SM

## Rod seal SM

High resistance to extrusion. Adjustable groove height not necessary. Simple solution.

**Design:** Rod packing set  
**Operating pressure:** up to 700 bar  
**Sliding speed max.:** 0,5 m/s  
**Temp. min.:** -30 °C  
**Temp. max.:** 110 °C  
**Media:** Mineral oils, Water emulsions  
**Installation:** in open installation spaces  
**Material:** (1) Thrust ring: laminated fabric-reinforced NBR, (2) Seal: NBR, (3) Support ring: acetal resin / PTBR  
**Application:** Hydraulics

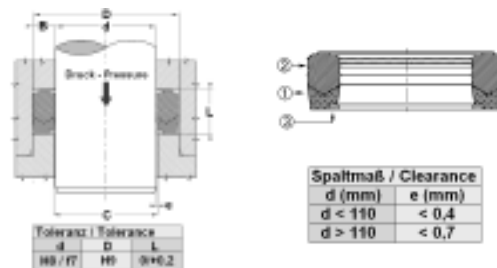

**Ordering information:** For special operating conditions (fluid, temperature, pressure ...) please contact us. Alternative material possible: FPM, EPDM.

Identification	D	d	L	Identification	D	d	L
	mm	mm	mm		mm	mm	mm
SM 169 118-1AX	43,00	30,00	20,00	SM 314 236-1BX	80,00	60,00	32,00
SM 177 137-1AX	45,00	35,00	25,59	SM 334 255-1AX	85,00	65,00	29,00
SM 185 137-1AX	47,00	35,00	22,50	SM 334 275-1AX	85,00	70,00	22,50
SM 196 137-1AX	50,00	35,00	22,50	SM 334 275-1BX	85,00	70,00	25,00
SM 200 141-1AX	51,00	36,00	22,50	SM 354 275-1AX	90,00	70,00	30,00
SM 204 157-1AX	52,00	40,00	22,50	SM 354 275-2AX	90,00	70,00	31,90
SM 216 157-1AX	55,00	40,00	22,62	SM 374 295-2AX	95,00	75,00	28,00
SM 236 157-1AX	60,00	40,00	30,00	SM 374 295-2CX	95,00	75,00	30,00
SM 236 177-1AX	60,00	45,00	22,50	SM 379 301-1AX	96,50	76,50	32,50
SM 248 196-1AX	63,00	50,00	20,00	SM 393 314-1AX	100,00	80,00	30,00
SM 255 177-1AX	65,00	45,00	28,00	SM 413 334-1AX	105,00	85,00	30,00
SM 255 196-1CX	65,00	50,00	22,50	SM 413 354-1AX	105,00	90,00	25,00
SM 255 196-1AX	65,00	50,00	24,50	SM 433 354-1AX	110,00	90,00	30,00
SM 262 200-1AX	66,67	50,80	24,90	SM 433 354-2BX	110,00	90,00	32,50
SM 275 196-1BX	70,00	50,00	30,00	SM 452 374-1AX	115,00	95,00	28,00
SM 275 216-2AX	70,00	55,00	22,50	SM 472 393-1AX	120,00	100,00	30,00
SM 275 216-1AX	70,00	55,00	25,00	SM 511 433-1AX	130,00	110,00	32,50
SM 279 220-1AX	71,00	56,00	25,00	SM 519 433-1AX	132,00	110,00	36,51
SM 295 216-2AX	75,00	55,00	30,00	SM 570 492-1AX	145,00	125,00	29,62
SM 295 236-2AX	75,00	60,00	22,50	SM 590 511-1AX	150,00	130,00	28,00
SM 295 236-1AX	75,00	60,00	25,00	SM 669 590-1AX	170,00	150,00	28,00
SM 303 236-1AX	77,00	60,00	27,00	SM 127 91181-1AX	325,00	300,00	35,00

**Web:** <http://cat.hansa-flex.com/en/SM>

SM M

## Rod seal SM M

High resistance to extrusion. Adjustable groove height not necessary. Simple solution.

**Design:** Rod packing set  
**Operating pressure:** up to 250 bar  
**Sliding speed max.:** 0,5 m/s  
**Temp. min.:** -30 °C  
**Temp. max.:** 110 °C  
**Media:** Mineral oils, Water emulsions  
**Installation:** in open installation spaces  
**Material:** (3) Support ring: acetal resin / PTBR, (4) Seal: fabric-reinforced NBR  
**Application:** Hydraulics

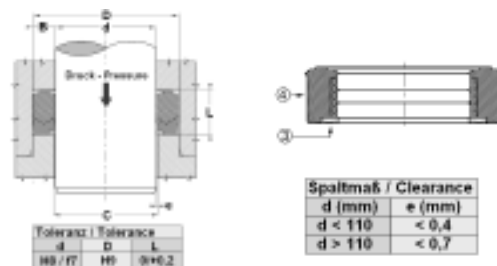

**Ordering information:** For special operating conditions (fluid, temperature, pressure ...) please contact us. Alternative material possible: FPM, EPDM.

Identification	D	d	L	Identification	D	d	L
	mm	mm	mm		mm	mm	mm
SM 255 196-M	65,00	50,00	22,50	SM 374 314-M	95,00	80,00	22,50
SM 295 236-M	75,00	60,00	22,50	SM 413 354-M	105,00	90,00	22,50
SM 334 275-M	85,00	70,00	22,50	SM 452 393-M	115,00	100,00	30,00

**Web:** <http://cat.hansa-flex.com/en/SM>

## TS

## Rod seal TS

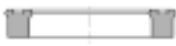

Spaltmaß / Clearance				
Druck bar	s (mm)			
	TS-TS...L	TS...AI-TS...LA	TS...AI-TS...LA	TS...LA
50	<math>\leq 0,40</math>	<math>\leq 0,50</math>	<math>\leq 0,60</math>	<math>\leq 0,80</math>
100	<math>\leq 0,30</math>	<math>\leq 0,40</math>	<math>\leq 0,60</math>	<math>\leq 0,80</math>
200	<math>\leq 0,20</math>	<math>\leq 0,30</math>	<math>\leq 0,40</math>	<math>\leq 0,60</math>
300	<math>\leq 0,15</math>	<math>\leq 0,20</math>	<math>\leq 0,30</math>	<math>\leq 0,40</math>
400	<math>\leq 0,10</math>	<math>\leq 0,15</math>	<math>\leq 0,20</math>	<math>\leq 0,30</math>
500			<math>\leq 0,10</math>	<math>\leq 0,15</math>

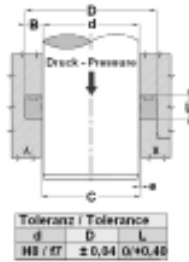

High abrasion resistance. Extremely good sealing effect at low pressure. Fast alternation of loads.

**Design:** Rod U-ring  
**Operating pressure:** up to 400 bar  
**Sliding speed max.:** 0,5 m/s  
**Temp. min.:** -30 °C  
**Temp. max.:** 80 °C  
**Media:** Mineral oils  
**Installation:** in open grooves B, in closed grooves in open installation spaces  
**Material:** PUR  
**Application:** Hydraulics

**Ordering information:** We are able to produce seals with diameters of 20 to 510 mm with short lead times.

Identification	d mm	D mm	L mm	Identification	d mm	D mm	L mm
TS 12 18	12	18,0	5,0	TS 38 45	38	45,0	7,0
TS 16 22	16	22,0	4,5	TS 40 50	40	50,0	7,0
TS 16 24-1	16	24,0	7,0	TS 42 53	42	53,0	10,0
TS 18 25	18	25,0	5,7	TS 45 53-1	45	53,0	7,0
TS 20 25	20	25,0	3,5	TS 45 53	45	53,0	9,0
TS 20 25-1	20	25,0	4,5	TS 46 54	46	54,0	9,0
TS 20 26	20	26,0	6,0	TS 50 62	50	62,0	11,0
TS 20 27	20	27,0	6,5	TS 56 66-1	56	66,0	7,5
TS 20 30	20	30,0	8,0	TS 56 66	56	66,0	11,0
TS 20 30-1	20	30,0	9,0	TS 60 70-3	60	70,0	13,0
TS 20 30-2	20	30,0	11,0	TS 61 69	61	69,0	9,0
TS 21 27	24	27,0	5,0	TS 63 71	63	70,0	9,0
TS 22 28	22	28,0	5,0	TS 66 80	66	80,0	11,0
TS 22 30	22	30,0	8,0	TS 68 76	68	76,0	9,0
TS 22 32-1	22	32,0	9,0	TS 70 80	70	80,0	8,0
TS 24 30	24	30,0	5,0	TS 70 80-2	70	80,0	13,0
TS 25 32	25	32,0	5,0	TS 72 78	72	78,0	7,0
TS 25 35	25	35,0	6,0	TS 76 84	76	84,0	9,0
TS 25 35-2	25	35,0	10,0	TS 85 97	85	97,0	9,5
TS 25 35-5	25	35,0	11,0	TS 88 96	88	96,0	9,0
TS 25 36	25	36,0	6,0	TS 90 96	90	96,0	5,5
TS 30 38	30	38,0	9,0	TS 90 100	90	100,0	7,5
TS 30 40-1	30	40,0	8,0	TS 91 99	91	99,0	9,0
TS 32 40	32	40,0	9,0	TS 107 115	107	115,0	9,0
TS 32 42-1	32	42,0	9,0	TS 126 134	126	134,0	9,0
TS 32 42-2	32	42,0	11,0	TS 145 153	145	153,0	9,0
TS 35 43-1	35	43,0	9,0	TS 147 155	147	155,0	11,0
TS 35 45	35	45,0	8,0	TS 175 183	175	183,5	9,0
TS 36 44	36	44,0	9,0	TS 221 229	221	229,5	13,0

**Web:** <http://cat.hansa-flex.com/en/TS>

## TS AI

## Rod seal TS-AI



Spaltmaß / Clearance				
Druck bar	s (mm)			
	TS-TS...L	TS...AI-TS...LA	TS...AI-TS...LA	TS...LA
50	<math>\leq 0,40</math>	<math>\leq 0,50</math>	<math>\leq 0,60</math>	<math>\leq 0,80</math>
100	<math>\leq 0,30</math>	<math>\leq 0,40</math>	<math>\leq 0,60</math>	<math>\leq 0,80</math>
200	<math>\leq 0,20</math>	<math>\leq 0,30</math>	<math>\leq 0,40</math>	<math>\leq 0,60</math>
300	<math>\leq 0,15</math>	<math>\leq 0,20</math>	<math>\leq 0,30</math>	<math>\leq 0,40</math>
400	<math>\leq 0,10</math>	<math>\leq 0,15</math>	<math>\leq 0,20</math>	<math>\leq 0,30</math>
500			<math>\leq 0,10</math>	<math>\leq 0,15</math>

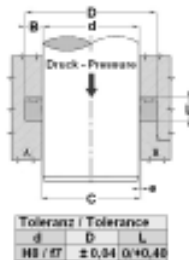

High abrasion resistance. Extremely good sealing effect at low pressure. Fast alternation of loads.

**Design:** Rod U-ring  
**Operating pressure:** up to 500 bar  
**Sliding speed max.:** 0,5 m/s  
**Temp. min.:** -30 °C  
**Temp. max.:** 80 °C  
**Media:** Mineral oils  
**Installation:** in closed grooves A, in open grooves B  
**Material:** (1) Seal: PUR, (2) Support ring: acetal resin / PTBR  
**Application:** Hydraulics

**Ordering information:** We are able to produce seals with diameters of 20 to 510 mm with short lead times.

Identification	d mm	D mm	L mm
TS 25 36-AI	25	36	6,0
TS 70 80-2-AI	70	80	13,0

**Web:** <http://cat.hansa-flex.com/en/TSAI>

## Rod seal TS-L

High abrasion resistance. Extremely good sealing effect at low pressure. Fast alternation of loads.

<b>Design:</b>	Rod U-ring
<b>Operating pressure:</b>	up to 400 bar
<b>Sliding speed max.:</b>	0,5 m/s
<b>Temp. min.:</b>	-30 °C
<b>Temp. max.:</b>	80 °C
<b>Media:</b>	Mineral oils
<b>Installation:</b>	in open grooves B, in closed grooves in open installation spaces
<b>Material:</b>	PUR
<b>Application:</b>	Hydraulics

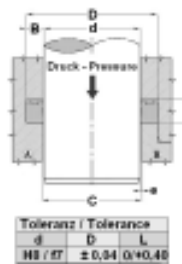

Druck Bar	Spaltmaß / Clearance e (mm)			
	TS-TS...L	TS...AI	TS...LA	TS...LA
50	<0,48	<0,50	<0,60	<0,80
100	<0,30	<0,40	<0,60	<0,80
200	<0,20	<0,30	<0,40	<0,60
300	<0,15	<0,20	<0,30	<0,40
400	<0,10	<0,15	<0,20	<0,30
500			<0,10	<0,15

**Ordering information:** We are able to produce seals with diameters of 20 to 510 mm with short lead times.

Identification	d mm	D mm	L mm	Identification	d mm	D mm	L mm
TS 06 14-L	6,0	14,0	6,3	TS 50 60-L2	50,0	60,0	10,0
TS 08 16-L	8,0	16,0	6,3	TS 50 60-L1	50,0	60,0	11,0
TS 10 16-L	10,0	16,0	5,4	TS 50 62-L1	50,0	62,0	9,0
TS 10 18-L	10,0	18,0	6,3	TS 50 65-L	50,0	65,0	11,0
TS 12 19-L	12,0	19,0	6,3	TS 50 65-L1	50,0	65,0	12,5
TS 12 20-L	12,0	20,0	6,3	TS 55 63-L	55,0	63,0	9,0
TS 12 23-L	12,0	23,0	7,5	TS 55 65-L	55,0	65,0	8,0
TS 14 20-L	14,0	20,0	5,3	TS 55 65-L1	55,0	65,0	11,0
TS 14 22-L	14,0	22,0	6,3	TS 55 65-L2	55,0	65,0	13,0
TS 16 24-L	16,0	24,0	6,3	TS 56 66-L1	56,0	66,0	7,5
TS 18 24-L	18,0	24,0	5,2	TS 56 71-L	56,0	71,0	12,5
TS 18 25-L	18,0	25,0	5,7	TS 60 68-L	60,0	68,0	9,0
TS 18 26-L	18,0	26,0	6,3	TS 60 70-L	60,0	70,0	8,0
TS 18 26-L1	18,0	26,0	9,0	TS 60 70-L1	60,0	70,0	11,0
TS 18 28-L	18,0	28,0	6,3	TS 60 70-L2	60,0	70,0	12,5
TS 18 28-L1	18,0	28,0	8,0	TS 60 70-L3	60,0	70,0	13,0
TS 20 26-L	20,0	26,0	6,0	TS 60 71-L	60,0	71,0	9,0
TS 20 28-L	20,0	28,0	6,3	TS 60 72-L	60,0	72,0	10,0
TS 20 28-L1	20,0	28,0	8,0	TS 60 75-L1	60,0	75,0	11,0
TS 20 30-L3	20,0	30,0	5,0	TS 61 69-L1	61,0	69,7	9,0
TS 20 30-L	20,0	30,0	8,0	TS 63 73-L	63,0	73,0	11,0
TS 22 30-L1	22,0	30,0	6,3	TS 63 75-L2	63,0	75,0	9,5
TS 22 32-L	22,0	32,0	8,0	TS 63 75-L1	63,0	75,0	11,0
TS 22 32-L1	22,0	32,0	9,0	TS 65 73-L	65,0	73,0	9,0
TS 24 34-L	24,0	34,0	6,5	TS 65 75-L	65,0	75,0	13,0
TS 25 33-L	25,0	33,0	6,3	TS 70 78-L	70,0	78,0	9,0
TS 25 33-L2	25,0	33,0	7,5	TS 70 80-L	70,0	80,0	8,0
TS 25 33-L3	25,0	33,0	8,0	TS 70 80-L1	70,0	80,0	11,0
TS 25 33-L1	25,0	33,0	9,0	TS 70 80-L2	70,0	80,0	13,0
TS 25 35-L3	25,0	35,0	6,3	TS 70 82-L	70,0	82,0	10,0
TS 25 35-L1	25,0	35,0	8,0	TS 70 85-L	70,0	85,0	12,5
TS 25 35-L4	25,0	35,0	9,0	TS 75 83-L1	75,0	83,0	9,0
TS 28 34-L	28,0	34,2	6,0	TS 75 85-L	75,0	85,0	8,0
TS 28 36-L1	28,0	28,0	6,3	TS 75 85-L1	75,0	85,0	13,0
TS 28 36-L	28,0	36,0	9,0	TS 78 86-L1	78,0	86,0	9,0
TS 28 38-L	28,0	38,0	6,3	TS 79 87-L	79,0	87,7	9,0
TS 28 38-L1	28,0	38,0	8,0	TS 80 88-L2	80,0	88,0	9,0
TS 30 38-L1	30,0	38,0	6,3	TS 80 88-L1	80,0	88,0	12,5
TS 30 38-L2	30,0	38,0	8,0	TS 80 90-L	80,0	90,0	8,0
TS 30 40-L	30,0	40,0	7,5	TS 80 90-L1	80,0	90,0	13,0
TS 30 40-L2	30,0	40,0	11,0	TS 80 92-L	80,0	92,0	9,6
TS 32 40-L1	32,0	40,0	6,3	TS 80 95-L	80,0	95,0	12,5
TS 32 40-L	32,0	40,0	9,0	TS 80 96-L	80,0	96,0	10,5
TS 32 42-L	32,0	42,0	8,0	TS 85 93-L	85,0	93,0	9,0
TS 32 42-L2	32,0	42,0	11,0	TS 85 95-L	85,0	95,0	8,0
TS 35 43-L2	35,0	43,0	6,3	TS 85 95-L1	85,0	95,0	13,0
TS 35 43-L	35,0	43,0	7,0	TS 88 101-L	88,9	101,6	10,5
TS 35 43-L1	35,0	43,0	9,0	TS 90 102-L	90,0	102,0	10,0
TS 35 45-L	35,0	45,0	8,0	TS 90 105-L	90,0	105,0	12,5
TS 35 45-L1	35,0	45,0	11,0	TS 95 103-L	95,0	103,0	9,0
TS 35 50-L	35,0	50,0	11,0	TS 98 106-L	98,0	106,7	9,0
TS 36 44-L1	36,0	44,0	6,3	TS 100 108-L	100,0	108,0	12,5
TS 36 46-L	36,0	46,0	8,0	TS 100 115-L	100,0	115,0	13,0
TS 40 48-L1	40,0	48,0	6,3	TS 105 113-L	105,0	113,0	9,0
TS 40 48-L2	40,0	48,0	7,0	TS 108 116-L	108,0	116,0	9,0
TS 40 48-L	40,0	48,0	9,0	TS 110 125-L	110,0	125,0	12,0
TS 40 50-L2	40,0	50,0	8,0	TS 115 123-L	115,0	123,0	9,0
TS 40 55-L1	40,0	55,0	11,0	TS 116 124-L	116,0	124,7	9,0
TS 40 60-L	40,0	60,0	11,0	TS 120 128-L1	120,0	128,0	12,5
TS 42 52-L	42,0	52,0	9,0	TS 125 133-L1	125,0	133,0	7,5
TS 45 53-L3	45,0	53,0	6,3	TS 130 145-L	130,0	145,0	16,0
TS 45 53-L	45,0	53,0	9,0	TS 135 143-L1	135,0	143,0	9,0
TS 45 55-L2	45,0	55,0	6,3	TS 135 143-L	135,0	143,7	9,0
TS 45 55-L	45,0	55,0	8,0	TS 135 150-L	135,0	150,0	12,5
TS 45 55-L1	45,0	55,0	11,0	TS 140 150-L	140,0	150,0	12,5
TS 45 57-L	45,0	57,0	10,5	TS 154 162-L	154,0	162,7	9,0
TS 49 65-L	49,5	65,3	11,0	TS 170 180-L	170,0	180,0	11,0
TS 50 58-L	50,0	58,0	9,0	TS 190 210-L	190,0	210,0	14,5
TS 50 60-L	50,0	60,0	8,0				

**Web:** <http://cat.hansa-flex.com/en/TSL>

## TS LA

## Rod seal TS-LA

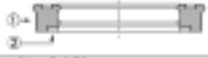

Spaltmaß / Clearance			
Druck bar	d (mm)		
	TS-TS...L	TS...AI-TS...LA	
50	<0,40	<0,50	<0,60
100	<0,30	<0,40	<0,50
200	<0,20	<0,30	<0,40
300	<0,15	<0,20	<0,30
400	<0,10	<0,15	<0,20
500		<0,10	<0,15

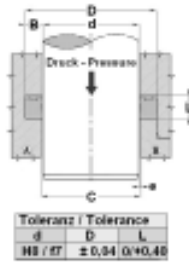

High abrasion resistance. Extremely good sealing effect at low pressure. Fast alternation of loads.

**Design:** Rod U-ring

**Operating pressure:** up to 500 bar

**Sliding speed max.:** 0,5 m/s

**Temp. min.:** -30 °C

**Temp. max.:** 80 °C

**Media:** Mineral oils

**Installation:** in closed grooves A, in open grooves B

**Material:** (1) Seal: PUR, (2) Support ring: acetal resin / PTBR

**Application:** Hydraulics

**Ordering information:** We are able to produce seals with diameters of 20 to 510 mm with short lead times.

Identification	d mm	D mm	L mm	Identification	d mm	D mm	L mm
TS 40 48-LA	40	48	9,0	TS 70 85-LA1	70	85	13,0
TS 40 50-LA1	40	50	11,0	TS 75 90-LA	75	90	13,0
TS 40 52-LA	40	52	11,0	TS 75 95-LA	75	95	14,5
TS 40 55-LA	40	55	8,5	TS 80 88-LA	80	88	10,0
TS 40 55-LA1	40	55	11,0	TS 80 95-LA	80	95	12,5
TS 45 55-LA1	45	55	11,0	TS 80 96-LA	80	96	10,5
TS 45 60-LA	45	60	11,0	TS 80 100-LA	80	100	12,5
TS 50 60-LA1	50	60	11,0	TS80 100-LA1	80	100	14,5
TS 50 65-LA	50	65	11,0	TS 90 105-LA2	90	105	9,5
TS 55 65-LA1	55	65	11,0	TS 90 105-LA1	90	105	13,0
TS 56 71-LA	56	71	12,5	TS 90 110-LA	90	110	13,0
TS 60 70-LA4	60	70	13,5	TS 95 115-LA	95	115	14,5
TS 60 75-LA	60	75	13,0	TS 100 110-LA	100	110	13,5
TS 60 80-LA	60	80	13,0	TS 100 113-LA	100	113	13,5
TS 63 75-LA	63	75	13,0	TS 100 120-LA	100	120	14,5
TS 63 78-LA1	63	78	12,5	TS 110 120-LA	110	120	14,5
TS 63 78-LA	63	78	13,5	TS 110 125-LA1	110	125	13,0
TS 63 83-LA	63	83	13,0	TS 120 140-LA	120	140	12,5
TS 65 75-LA	65	75	13,0	TS 140 165-LA	140	165	19,0
TS 65 80-LA	65	80	12,5				

**Web:** <http://cat.hansa-flex.com/en/TSLA>



## B NEO

## Piston seal B-NEO

Low spatial requirement. High resistance to extrusion.

**Design:** piston seal  
**Operating pressure:** up to 500 bar  
**Sliding speed max.:** 0,5 m/s  
**Temp. min.:** -30 °C  
**Temp. max.:** 110 °C  
**Media:** Mineral oils, Water emulsions  
**Installation:** on one-piece pistons  
**Material:** (2) Seal: fabric-reinforced NBR, (3) Back ring: acetal resin  
**Application:** Hydraulics

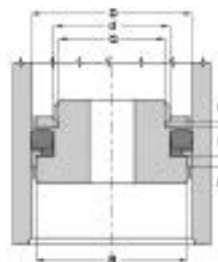

Toleranz / Tolerance	
D	d L R P G G E
H11	h8, h9, h10, h11, h12, h13, h14, h15, h16, h17, h18, h19, h20, h21, h22, h23, h24, h25, h26, h27, h28, h29, h30, h31, h32, h33, h34, h35, h36, h37, h38, h39, h40, h41, h42, h43, h44, h45, h46, h47, h48, h49, h50, h51, h52, h53, h54, h55, h56, h57, h58, h59, h60, h61, h62, h63, h64, h65, h66, h67, h68, h69, h70, h71, h72, h73, h74, h75, h76, h77, h78, h79, h80, h81, h82, h83, h84, h85, h86, h87, h88, h89, h90, h91, h92, h93, h94, h95, h96, h97, h98, h99, h100

**Ordering information:** For special operating conditions (fluid, temperature, pressure ...) please contact us. Alternative material possible: FPM.

Identification	D	d	L	Identification	D	d	L
	mm	mm	mm		mm	mm	mm
B 157 102-NEO	40,00	26,0	9,4	B 354 275-NEO	90,00	70,0	14,5
B 216 157-1-NEO	55,00	40,0	11,0	B 393 314-NEO	100,00	80,0	14,5
B 314 236-NEO	80,00	60,0	14,5				

**Web:** <http://cat.hansa-flex.com/en/BNEO>

## B NWO

## Piston seal B-NWO

Low spatial requirement. High resistance to extrusion.

**Design:** piston seal  
**Operating pressure:** up to 500 bar  
**Sliding speed max.:** 0,5 m/s  
**Temp. min.:** -30 °C  
**Temp. max.:** 110 °C  
**Media:** Mineral oils, Water emulsions  
**Installation:** on one-piece pistons  
**Material:** (1) Guide ring: acetal resin, (2) Seal: fabric-reinforced NBR  
**Application:** Hydraulics

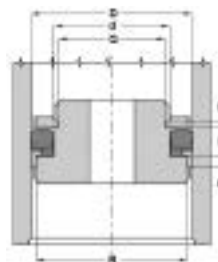

Toleranz / Tolerance	
D	d L R P G G E
H11	h8, h9, h10, h11, h12, h13, h14, h15, h16, h17, h18, h19, h20, h21, h22, h23, h24, h25, h26, h27, h28, h29, h30, h31, h32, h33, h34, h35, h36, h37, h38, h39, h40, h41, h42, h43, h44, h45, h46, h47, h48, h49, h50, h51, h52, h53, h54, h55, h56, h57, h58, h59, h60, h61, h62, h63, h64, h65, h66, h67, h68, h69, h70, h71, h72, h73, h74, h75, h76, h77, h78, h79, h80, h81, h82, h83, h84, h85, h86, h87, h88, h89, h90, h91, h92, h93, h94, h95, h96, h97, h98, h99, h100

**Ordering information:** For special operating conditions (fluid, temperature, pressure ...) please contact us. Alternative material possible: FPM.

Identification	D	d	L	G	R
	mm	mm	mm	mm	mm
B 354 275-NWO	90,0	70,00	14,5	6,35	84,15
B 393 314-NWO	100,0	80,00	14,5	6,35	94,15
B 411 334-NWO	104,5	85,00	13,0	6,35	98,90
B 472 393-NWO	120,0	100,00	14,5	6,35	114,10

**Web:** <http://cat.hansa-flex.com/en/BNWO>

**B NWO-KR****Piston seal B-NWO-KR**

Toleranz / Tolerance							
D	d	L	R	P	G	Q	E
H11	h8	h8	h8	h8	h8	h8	h8

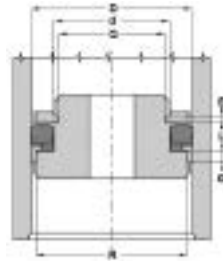

Low spatial requirement. High resistance to extrusion.

- Design:** piston seal  
**Operating pressure:** up to 500 bar  
**Sliding speed max.:** 0,5 m/s  
**Temp. min.:** -30 °C  
**Temp. max.:** 110 °C  
**Media:** Mineral oils, Water emulsions  
**Installation:** on one-piece pistons  
**Material:** (1) Guide ring: acetal resin, (2) Seal: fabric-reinforced NBR, (4) Seeger ring: acetal resin  
**Application:** Hydraulics

**Ordering information:** For special operating conditions (fluid, temperature, pressure ...) please contact us. Alternative material possible: FPM.

Identification	D	d	L	G	E	R	Q
	mm	mm	mm	mm	mm	mm	mm
B 177 118-NWO-KR	45,0	30	9,5	6,35	3,10	40,40	25,80
B 196 118-NWO-KR	50,0	30	14,5	6,35	3,35	44,30	25,80
B 216 157-1-NWO-K	55,0	40	11,0	6,35	3,10	50,40	35,80
B 236 157-NWO-KR	60,0	40	14,5	6,35	3,35	54,16	36,10
B 248 177-NWO-KR	63,0	45	11,0	6,35	3,10	58,40	40,84
B 275 196-NWO-KR	70,0	50	14,5	6,35	3,35	64,20	45,84
B 314 236-NWO-KR	80,0	60	14,5	6,35	3,35	74,30	55,80
B 354 275-NWO-KR	90,0	70	14,5	6,35	3,35	84,15	66,10
B 393 314-NWO-KR	100,0	80	14,5	6,35	3,35	94,15	75,84
B 411 334-NWO-KR	104,5	85	13,0	6,35	3,35	98,90	81,10
B 433 354-1-NWO-K	110,0	90	13,0	6,35	3,10	104,15	85,90
B 452 374-NWO-KR	115,0	95	14,5	6,35	3,35	109,90	90,50
B 492 413-NWO-KR	125,0	105	12,5	6,35	3,35	119,15	101,00
B 629 551-1-NWO-K	160,0	140	14,0	6,35	3,20	154,30	136,00

**Web:** <http://cat.hansa-flex.com/en/BNWOKR>

## CH3

## Chevron piston ring CH3

High temperature resistance. for difficult working conditions such as hydraulic shocks, Strong vibrations or poor surfaces.

**Design:** Chevron piston ring  
**Operating pressure:** up to 400 bar  
**Sliding speed max.:** 0,5 m/s  
**Temp. min.:** -30 °C  
**Temp. max.:** 110 °C  
**Media:** Mineral oils, Water emulsions  
**Installation:** on multi-part pistons  
**Material:** (1) Thrust ring: laminated fabric-reinforced NBR, (2) Chevron ring: fabric-reinforced NBR, (3) Support ring: acetal resin / PTBR  
**Application:** Hydraulics

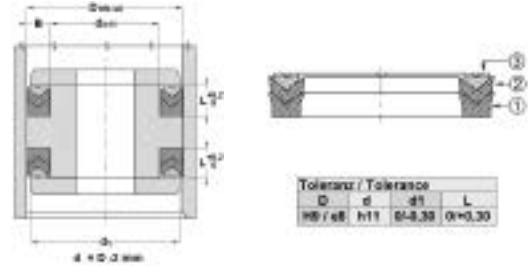

**Ordering information:** For special operating conditions (fluid, temperature, pressure ...) please contact us. Alternative material possible: FPM.

Identification	D	d	L	Identification	D	d	L
	mm	mm	mm		mm	mm	mm
CH3-030	30	20	9,3	CH3-100	100	80	21,2
CH3-032	32	20	10,9	CH3-110	110	90	21,2
CH3-040	40	25	11,5	CH3-115	115	95	21,2
CH3-045	45	30	11,5	CH3-125	125	100	25,8
CH3-050	50	35	11,5	CH3-140	140	115	25,8
CH3-055	55	40	11,5	CH3-150	150	120	29,0
CH3-060	60	45	11,5	CH3-160	160	130	29,0
CH3-063	63	48	13,0	CH3-180	180	150	31,5
CH3-065	65	50	13,0	CH3-200	200	170	33,5
CH3-070	70	50	15,2	CH3-225	225	195	33,5
CH3-080	80	60	15,2	CH3-250	250	220	33,5
CH3-090	90	70	21,2	CH3-300	300	270	33,5

**Web:** <http://cat.hansa-flex.com/en/CH3>

## CH3 FPM-C

## Chevron piston ring CH3

High temperature resistance. for difficult working conditions such as hydraulic shocks, Strong vibrations or poor surfaces.

**Design:** Chevron piston ring  
**Operating pressure:** up to 400 bar  
**Sliding speed max.:** 0,5 m/s  
**Temp. min.:** -30 °C  
**Temp. max.:** 150 °C  
**Media:** Mineral oils, Water emulsions  
**Installation:** on multi-part pistons

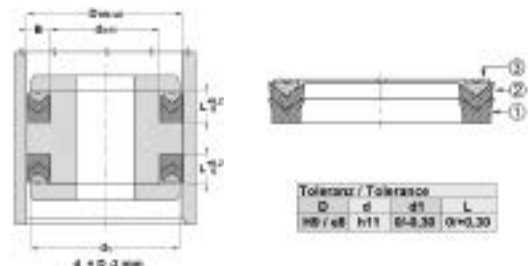

**Ordering information:** For special operating conditions (fluid, temperature, pressure ...) please contact us.

Identification	D	d	L
	mm	mm	mm
CH3-100 FPM-C	100	80	21,2
CH3-140 FPM-C	140	115	25,8

**Web:** <http://cat.hansa-flex.com/en/CH3FPMC>

**D11W****Piston packing set for split pistons D11W**

Toleranz / Tolerance					
D	d	L	G	M	P
H11	+0,10 g	+0,25 D	+0,10 g	±0,05	±0,10

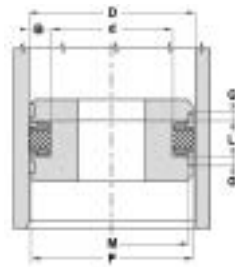

Extremely good sealing effect at low pressure. Low spatial requirement. Simple solution.

**Operating pressure:** up to 500 bar

**Sliding speed max.:** 0,5 m/s

**Temp. min.:** -30 °C

**Temp. max.:** 110 °C

**Media:** Mineral oils, Water emulsions  
on multi-part pistons

**Installation:**

**Material:** (1) Seal: NBR with fabric reinforcement on both sides,  
(2) Guide ring: acetal resin, (3) Support ring: acetal resin  
/ PTBR

**Application:** Hydraulics

**Ordering information:** For special operating conditions (fluid, temperature, pressure ...) please contact us. Alternative material possible: FPM.

Identification	D	d	L	G	M	P
	mm	mm	mm	mm	mm	mm
D11W 980 47	25,00	12,00	12,40	6,35	21,45	23,73
D11W 150 100	38,10	25,40	16,27	6,35	34,54	37,05
D11W 200 137	50,80	34,92	19,45	6,35	46,22	49,50
D11W 248 185	63,00	47,00	19,40	6,35	58,40	61,65
D11W 250 187	63,50	47,62	19,45	6,35	58,90	62,13
D11W 295 220	75,00	56,00	24,40	6,35	69,20	73,30
D11W 300 225	76,20	57,15	24,21	6,35	70,40	74,55
D11W 325 250	82,55	63,50	24,21	6,35	76,73	80,90
D11W 354 275-1	90,00	70,00	25,40	6,35	84,15	88,30
D11W 400 325	101,60	82,55	24,21	6,35	95,76	99,90
D11W 413 314	105,00	80,00	22,40	6,35	98,10	103,00
D11W 425 350	107,95	88,90	24,21	6,35	102,08	106,23
D11W 433 334	110,00	85,00	25,40	6,35	103,10	108,00
D11W 433 354	110,00	90,00	25,40	6,35	104,15	108,30
D11W 452 354	115,00	90,00	22,40	6,35	108,10	113,00
D11W 492 393	125,00	100,00	25,40	6,35	118,10	123,00
D11W 492 413	125,00	105,00	25,40	6,35	119,15	123,30
D11W 500 400	127,00	101,60	32,15	6,35	120,09	124,98
D11W 550 450	139,70	114,30	32,15	6,35	132,77	137,65
D11W 551 472	140,00	120,00	25,40	6,35	134,10	138,30
D11W 590 472	150,00	120,00	38,40	6,35	143,00	148,00
D11W 629 511	160,00	130,00	25,40	6,35	153,00	157,90
D11W 650 550	165,10	139,70	32,15	6,35	158,12	163,01
D11W 708 590	180,00	150,00	35,40	6,35	172,95	177,87
D11W 748 629	190,00	160,00	35,40	6,35	182,93	187,87
D11W 787 669	200,00	170,00	35,40	6,35	192,96	197,84

**Web:** <http://cat.hansa-flex.com/en/D11W>

**DAS**
**Piston packing set for one-piece pistons DAS**

Extremely good sealing effect at low pressure. Easy assembly. Simple solution.

- Design:** Piston packing set  
**Operating pressure:** up to 300 bar  
**Sliding speed max.:** 0,5 m/s  
**Temp. min.:** -30 °C  
**Temp. max.:** 110 °C  
**Media:** Mineral oils, Water emulsions  
**Installation:** on one-piece pistons A, on multi-part pistons B  
**Material:** (1) Seal: NBR, (2) Guide ring: acetal resin, (3) Support ring: Polyester  
**Application:** Hydraulics

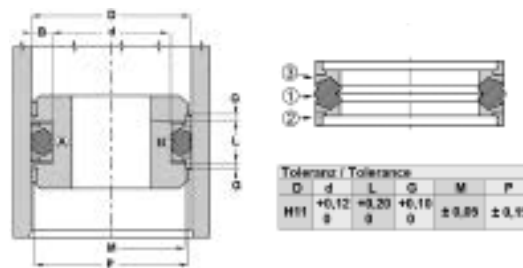

**Ordering information:** Alternative material possible: FPM.

Identification	D mm	d mm	L mm	G mm	M mm	P mm
DAS 30 17	30	17	15,4	6,35	26,50	28,50
DAS 40 24	40	24	18,4	6,35	35,40	38,50
DAS 40 30	40	30	16,4	6,35	35,40	38,50
DAS 50 34	50	34	18,4	6,35	45,41	48,66
DAS 60 44	60	44	18,4	6,35	55,39	58,65
DAS 63 47	63	47	18,4	6,35	58,39	61,63
DAS 70 50	70	50	22,4	6,35	64,18	68,34
DAS 80 60	80	60	22,4	6,35	74,16	78,34
DAS 90 70	90	70	22,4	6,35	84,15	88,31
DAS 100 75	100	75	22,4	6,35	93,14	98,05
DAS 110 85	110	85	22,4	6,35	103,10	108,00
DAS 125 100	125	100	25,4	6,35	118,08	122,96
DAS 130 105	130	105	25,4	9,50	122,60	127,50
DAS 140 115	140	115	25,4	9,50	132,60	137,50
DAS 150 125	150	125	25,4	9,50	142,60	147,50
DAS 160 135	160	135	25,4	9,50	152,60	157,50
DAS 180 155	180	155	25,4	12,70	171,72	177,10
DAS 200 175	200	175	25,4	12,70	191,62	197,00
DAS 220 195	220	195	25,4	12,70	211,62	217,00

**Web:** <http://cat.hansa-flex.com/en/DAS>

**DBM**
**Piston packing set for one-piece pistons DBM**

Extremely good sealing effect at low pressure. Easy assembly. Simple solution.

- Design:** Piston packing set  
**Operating pressure:** up to 300 bar  
**Sliding speed max.:** 0,5 m/s  
**Temp. min.:** -30 °C  
**Temp. max.:** 110 °C  
**Media:** Mineral oils, Water emulsions  
**Installation:** on one-piece pistons A, on multi-part pistons B  
**Material:** (1) Seal: NBR, (2) Guide ring: acetal resin, (3) Support ring: Polyester  
**Application:** Hydraulics

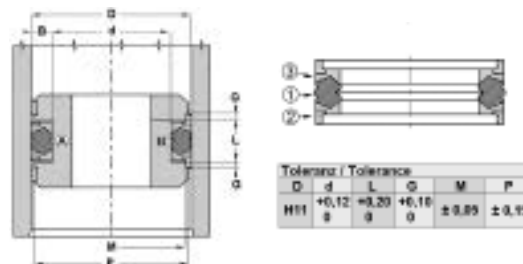

**Ordering information:** Alternative material possible: FPM.

Identification	D mm	d mm	L mm	G mm	M mm	P mm	Standard grooves
DBM 078 043-M	20,00	11,00	13,50	2,10	17,00	19,00	
DBM 086 051-M	22,00	13,00	13,50	2,10	19,00	21,00	
DBM 098 059-1	25,00	15,00	12,50	4,00	21,00	23,00	
DBM 098 059-2	25,00	15,00	12,50	4,00	22,00	24,00	ISO 5597
DBM 098 059	25,00	15,00	16,40	6,35	21,45	23,50	
DBM 098 063-M	25,00	16,00	13,50	2,10	22,00	24,00	
DBM 098 066-SI	25,00	17,00	13,50	3,20	21,00	24,40	
DBM 110 074-M	28,00	19,00	13,50	2,10	25,00	27,00	
DBM 118 083-M	30,00	21,00	13,50	2,10	27,00	29,00	
DBM 125 086-ISO	32,00	22,00	12,50	4,00	29,00	31,00	ISO 5597
DBM 125 086-M	32,00	22,00	15,50	2,60	28,00	31,00	
DBM 125 086	32,00	22,00	16,40	6,35	28,50	30,50	
DBM 125 094-ISO	32,00	24,00	10,00	4,00	29,00	31,00	ISO 5597
DBM 125 094-SI	32,00	24,00	15,50	3,20	28,00	31,40	
DBM 137 098-M	35,00	25,00	15,50	2,60	31,00	34,00	
DBM 137 098	35,00	25,00	16,40	6,35	31,40	33,50	
DBM 137 106-SI	35,00	27,00	15,50	3,20	31,00	34,40	
DBM 157 102-M	40,00	26,00	15,50	2,60	36,00	39,00	
DBM 157 118-1	40,00	30,00	12,50	4,00	36,00	38,00	
DBM 157 118-2	40,00	30,00	12,50	4,00	37,00	39,00	ISO 5597

## Piston packing set for one-piece pistons DBM

Identification	D mm	d mm	L mm	G mm	M mm	P mm	Standard grooves
DBM 157 125-ISO	40,00	32,00	10,00	4,00	37,00	39,00	ISO 5597
DBM 157 125-SI	40,00	32,00	15,50	3,20	36,00	39,40	
DBM 165 110-M	42,00	28,00	15,50	2,60	38,00	41,00	
DBM 175 112	44,45	28,57	19,05	6,35	39,87	43,12	
DBM 177 114	45,00	29,00	18,40	6,35	40,40	43,50	
DBM 177 122-M	45,00	31,00	15,50	2,60	41,00	44,00	
DBM 177 137	45,00	35,00	16,40	6,35	40,40	43,50	
DBM 196 133-M	50,00	34,00	20,50	3,10	46,00	49,00	
DBM 196 137-ISO	50,00	35,00	20,00	5,00	46,00	48,50	ISO 5597
DBM 196 149-SI	50,00	38,00	20,50	4,20	46,00	49,40	
DBM 196 157-ISO	50,00	40,00	12,50	4,00	47,00	49,00	ISO 5597
DBM 200 137	50,80	34,92	19,05	6,35	46,23	49,48	
DBM 200 162	50,80	41,27	11,10	3,81	46,27	49,19	
DBM 212 150	53,97	38,10	19,05	6,35	49,40	52,70	
DBM 216 153	55,00	39,00	18,40	6,35	50,37	53,65	
DBM 216 153-M	55,00	39,00	20,50	3,10	51,00	54,00	
DBM 216 177-ISO	55,00	45,00	12,50	4,00	52,00	54,00	ISO 5597
DBM 220 157-M	56,00	40,00	20,50	3,10	52,00	55,00	
DBM 236 173-M	60,00	44,00	20,50	3,10	56,00	59,00	
DBM 236 188-SI	60,00	48,00	20,50	4,20	56,00	59,40	
DBM 237 175	60,32	44,45	19,05	6,35	55,73	59,98	
DBM 248 185-2	63,00	47,00	19,40	6,35	58,40	61,50	
DBM 248 185-M	63,00	47,00	20,50	3,10	59,00	62,00	
DBM 248 188ISO	63,00	48,00	20,00	5,00	59,00	61,50	ISO 5597
DBM 248 188-ISO	63,00	48,00	20,00	5,00	59,00	61,50	ISO 5597
DBM 248 201-SI	63,00	51,00	20,50	4,20	59,00	62,40	
DBM 248 208-ISO	63,00	53,00	12,50	4,00	60,00	62,00	ISO 5597
DBM 250 187	63,50	47,62	19,05	6,35	58,90	62,12	
DBM 250 212	63,50	53,97	11,10	3,80	59,00	62,12	
DBM 255 192-M	65,00	49,00	20,50	4,10	61,00	64,00	
DBM 255 196	65,00	50,00	18,40	6,35	60,41	63,64	
DBM 262 200	66,67	50,80	19,05	6,35	62,10	65,27	
DBM 275 212-M	70,00	54,00	20,50	3,10	66,00	69,00	
DBM 275 216-ISO	70,00	55,00	20,00	5,00	66,00	68,50	ISO 5597
DBM 275 228-SI	70,00	58,00	20,50	4,20	66,00	69,40	
DBM 295 216	75,00	55,00	22,40	6,35	69,18	73,32	
DBM 295 232-M	75,00	59,00	20,50	3,10	71,00	74,00	
DBM 300 225	76,20	57,15	23,80	6,35	70,40	74,50	
DBM 314 236-ISO	80,00	60,00	25,00	6,30	75,00	78,00	ISO 5597
DBM 314 244-M	80,00	62,00	22,50	3,60	76,00	79,00	
DBM 314 255-ISO	80,00	65,00	20,00	5,00	76,00	78,50	ISO 5597
DBM 314 259-SI	80,00	66,00	22,50	5,20	76,00	79,40	
DBM 334 255	85,00	65,00	22,40	6,35	79,16	83,34	
DBM 350 275	88,90	69,85	23,80	6,35	83,08	87,22	
DBM 354 283-M	90,00	72,00	22,50	3,60	86,00	89,00	
DBM 354 295-ISO	90,00	75,00	20,00	5,00	86,00	88,50	ISO 5597
DBM 354 299-SI	90,00	76,00	22,50	5,20	86,00	89,40	
DBM 374 295	95,00	75,00	22,40	6,35	89,15	93,31	
DBM 393 314-ISO	100,00	80,00	25,00	6,30	95,00	98,00	ISO 5597
DBM 393 314	100,00	80,00	25,40	6,35	94,15	98,31	
DBM 393 332-M	100,00	82,00	22,50	3,60	96,00	99,00	
DBM 393 334-ISO	100,00	85,00	20,00	5,00	96,00	98,50	ISO 5597
DBM 393 339-SI	100,00	86,00	22,50	5,20	96,00	99,40	
DBM 400 325	101,60	82,55	24,21	6,35	95,76	99,90	
DBM 413 314	105,00	80,00	22,40	6,35	98,09	103,03	
DBM 433 334-1	110,00	85,00	25,40	6,35	103,10	108,00	
DBM 433 362-M	110,00	92,00	22,50	3,60	106,00	109,00	
DBM 433 374-ISO	110,00	95,00	20,00	5,00	105,00	108,00	ISO 5597
DBM 433 378-SI	110,00	96,00	22,50	5,20	106,00	109,40	
DBM 452 354	115,00	90,00	22,40	6,35	108,10	113,02	
DBM 452 381-M	115,00	97,00	22,50	3,60	111,00	114,00	
DBM 472 417-SI	120,00	106,00	22,50	5,20	116,00	119,40	
DBM 492 393-ISO	125,00	100,00	32,00	10,00	119,00	123,00	ISO 5597
DBM 492 405-M	125,00	103,00	26,50	5,10	121,00	124,00	
DBM 492 413-ISO	125,00	105,00	25,00	6,30	120,00	123,00	ISO 5597
DBM 492 413	125,00	105,00	25,00	6,35	119,10	123,30	
DBM 492 425-SI	125,00	108,00	26,50	7,20	121,00	124,40	
DBM 511 413-1	130,00	105,00	25,40	6,35	123,10	128,00	
DBM 523 452	133,00	115,00	22,40	9,52	125,60	130,50	
DBM 531 433	135,00	110,00	25,40	9,52	127,60	132,50	
DBM 531 433-1	135,00	110,00	25,40	6,35	128,10	133,00	
DBM 551 452-1	140,00	115,00	25,40	6,35	133,00	138,00	
DBM 551 464-M	140,00	118,00	26,50	5,10	136,00	139,00	
DBM 551 472-ISO	140,00	120,00	25,00	6,30	135,00	138,00	ISO 5597
DBM 551 484-SI	140,00	123,00	26,50	7,20	136,00	139,40	
DBM 570 472	145,00	120,00	25,40	9,52	137,60	142,50	
DBM 570 472-1	145,00	120,00	25,40	6,35	138,30	142,95	
DBM 590 492-1	150,00	125,00	25,40	6,35	143,00	148,00	
DBM 590 503-M	150,00	128,00	26,50	5,10	146,00	149,00	
DBM 590 523-SI	150,00	133,00	26,50	7,20	146,00	149,40	
DBM 600 500	152,40	127,00	31,75	9,52	145,00	149,91	
DBM 610 511	155,00	130,00	25,40	9,52	147,60	152,50	
DBM 610 511-1	155,00	130,00	25,40	6,35	148,00	153,00	
DBM 629 511	160,00	130,00	25,40	9,52	152,60	157,50	
DBM 629 511-1	160,00	130,00	25,40	6,35	153,00	157,50	
DBM 629 531-ISO	160,00	135,00	32,00	10,00	154,00	158,00	ISO 5597
DBM 629 543-M	160,00	138,00	26,50	5,10	156,00	159,00	
DBM 629 551-ISO	160,00	140,00	25,00	6,30	155,00	158,00	ISO 5597
DBM 629 563-SI	160,00	143,00	26,50	7,20	156,00	159,40	
DBM 649 551	165,00	140,00	25,40	9,52	157,60	162,50	
DBM 669 570	170,00	145,00	25,40	12,70	161,72	167,10	
DBM 669 582-M	170,00	148,00	26,50	5,10	166,00	169,00	

(Continued)

DBM

## Piston packing set for one-piece pistons DBM

Identification	D mm	d mm	L mm	G mm	M mm	P mm	Standard grooves
DBM 688 590	175,00	150,00	25,40	12,70	166,72	172,10	
DBM 708 590-1	180,00	150,00	35,40	6,35	172,95	177,87	
DBM 708 621-M	180,00	158,00	26,50	5,10	176,00	179,00	
DBM 728 629	185,00	160,00	25,40	12,70	176,72	182,10	
DBM 748 649	190,00	165,00	25,40	12,70	181,72	187,05	
DBM 767 669	195,00	170,00	25,40	12,70	186,72	192,05	
DBM 787 669-1	200,00	170,00	35,40	6,35	192,96	197,84	
DBM 787 669-ISO	200,00	170,00	36,00	12,50	192,00	197,00	ISO 5597
DBM 787 688-M	200,00	175,00	31,50	6,60	196,00	199,00	
DBM 787 708-SI	200,00	180,00	31,50	9,20	196,00	199,40	
DBM 826 728	210,00	185,00	25,40	12,70	201,62	207,00	
DBM 866 748	220,00	190,00	35,40	6,35	212,70	217,90	
DBM 905 807	230,00	205,00	25,40	12,70	221,62	227,00	
DBM 944 846	240,00	215,00	25,40	12,70	231,62	237,00	
DBM 984 866	250,00	220,00	35,40	6,35	242,90	247,85	
DBM 984 886	250,00	225,00	25,40	12,70	241,62	247,00	

Web: <http://cat.hansa-flex.com/en/DBM>

DBM FPM

## Piston packing set for one-piece pistons DBM-FPM

Extremely good sealing effect at low pressure. Easy assembly. Simple solution.

**Design:** Piston packing set  
**Operating pressure:** up to 300 bar  
**Sliding speed max.:** 0,5 m/s  
**Temp. min.:** -30 °C  
**Temp. max.:** 110 °C  
**Media:** Mineral oils, Water emulsions  
**Installation:** on one-piece or multi-part pistons  
**Material:** (1) Seal: FPM, (2) Guide ring: acetal resin, (3) Support ring: Polyester  
**Application:** Hydraulics

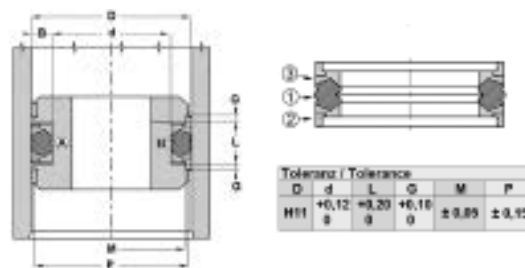

Toleranz / Tolerance					
D	d	L	G	M	P
H11	+0,12	+0,20	+0,10	±0,05	±0,15
g	g	g	g		

Ordering information: Alternative material possible

Identification	D mm	d mm	L mm	G mm	M mm	P mm
DBM 157 118 FPM	40	30	16,4	6,35	35,40	38,50
DBM 196 133 FPM	50	34	18,4	6,35	45,41	44,66
DBM 236 173 FPM	60	44	18,4	6,35	55,39	58,65
DBM 248 185 FPM	63	47	18,4	6,35	58,39	61,63
DBM 275 196 FPM	70	50	22,4	6,35	64,18	68,34
DBM 314 236 FPM	80	60	22,4	6,35	74,16	78,34
DBM 393 295 FPM	100	75	22,4	6,35	93,14	98,05

Web: <http://cat.hansa-flex.com/en/DBMFPM>

DBM NEO

## Piston packing set for one-piece pistons DBM-NEO

Extremely good sealing effect at low pressure. Easy assembly. Simple solution.

**Operating pressure:** up to 300 bar  
**Sliding speed max.:** 0,5 m/s  
**Temp. min.:** -30 °C  
**Temp. max.:** 110 °C  
**Media:** Mineral oils, Water emulsions  
**Installation:** on one-piece or multi-part pistons  
**Material:** (1) Seal: NBR, (3) Support ring: Polyester, (4) Back ring: acetal resin  
**Application:** Hydraulics

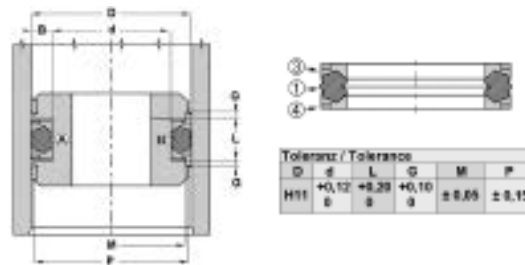

Toleranz / Tolerance					
D	d	L	G	M	P
H11	+0,12	+0,20	+0,10	±0,05	±0,15
g	g	g	g		

Ordering information: Alternative material possible

Identification	D mm	d mm	L mm
DBM 157 118-NEO	40	30	16,4
DBM 236 173-NEO	60	44	18,4
DBM 314 236-NEO	80	60	22,4

Web: <http://cat.hansa-flex.com/en/DBMNEO>

## DDE

## Piston seal, DDE



Toleranz / Tolerance		
D	d	L
H9 / e8	h9	+0,50 0

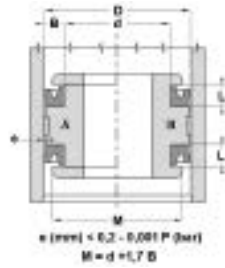

Low-friction seal. Simple solution.

**Design:** Piston U-ring

**Operating pressure:** up to 80 bar

**Sliding speed max.:** 0,5 m/s

**Design:** Inches

**Temp. min.:** -30 °C

**Temp. max.:** 100 °C

**Media:** Mineral oils, Water-air

**Installation:** on one-piece pistons A, on multi-part pistons B

**Material:** NBR 75° Shore A

**Application:** Hydraulics + pneumatics

**Ordering information:** We are able to produce seals with diameters of 20 to 510 mm with short lead times.

Identification	D mm	d mm	L mm	H mm
DDE 50	13,00	6,70	6,30	4,76
DDE 62	16,00	8,10	7,00	5,55
DDE 75	19,05	12,70	5,00	3,17
DDE 100	25,40	16,50	8,00	6,35
DDE 106	27,00	17,50	8,00	6,35
DDE 112	29,00	19,05	8,00	6,35
DDE 125	32,00	19,30	8,00	6,35
DDE 137	35,00	22,30	8,00	6,35
DDE 143	37,00	26,00	8,00	6,35
DDE 150	38,00	30,00	8,00	6,35
DDE 150100	38,10	25,40	9,52	7,92
DDE 156	40,00	27,30	8,00	6,35
DDE 162	42,00	30,90	8,00	6,35
DDE 175112	44,45	28,57	11,10	9,52
DDE 175	45,00	35,50	8,50	7,00
DDE 200	51,00	41,50	9,00	7,14
DDE 212150	53,97	38,10	11,10	9,52
DDE 250	64,00	46,30	10,50	8,85
DDE 300	76,00	57,90	10,50	8,73
DDE 300225	76,20	57,15	14,30	12,70
DDE 312	80,00	67,30	8,00	6,35
DDE 387	99,00	86,30	11,00	9,52
DDE 400	102,00	89,30	11,00	9,52
DDE 437	111,00	94,70	9,50	7,93

**Web:** <http://cat.hansa-flex.com/en/DDE>



## DDEM

## Piston seal DDEM

Low-friction seal. Simple solution.

**Design:** Piston U-ring  
**Operating pressure:** up to 80 bar  
**Sliding speed max.:** 0,5 m/s  
**Design:** Metric  
**Temp. min.:** -30 °C  
**Temp. max.:** 100 °C  
**Media:** Mineral oils, Water-air  
**Installation:** on one-piece pistons A, on multi-part pistons B  
**Material:** NBR 75° Shore A  
**Application:** Hydraulics + pneumatics

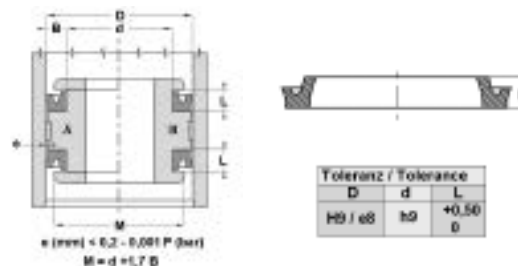

**Ordering information:** We are able to produce seals with diameters of 20 to 510 mm with short lead times.

Identification	D mm	d mm	L mm	H mm
DDEM 12 06	12,0	6,00	4,5	4,00
DDEM 16 10	16,0	10,00	4,5	4,00
DDEM 20 12	20,0	12,00	6,0	5,50
DDEM 25 17	25,0	17,00	6,0	5,50
DDEM 32 24	32,0	24,00	6,0	5,50
DDEM 40 30	40,0	30,00	7,5	7,00
DDEM 50 40	50,0	40,00	7,5	7,00
DDEM 55 45	55,0	45,00	7,5	7,00
DDEM 60 50	60,0	50,00	7,5	7,00
DDEM 63 53	63,0	53,00	7,5	7,00
DDEM 65 55	65,0	55,00	7,5	7,00
DDEM 70 58	70,0	58,00	9,5	8,50
DDEM 75 63	75,0	63,00	9,5	8,50
DDEM 80 68	80,0	68,00	9,5	8,50
DDEM 85 73	85,0	73,00	9,5	8,50
DDEM 90 78	90,0	78,00	9,5	8,50
DDEM 100 088	100,0	88,00	9,5	8,50
DDEM 105 093	105,0	93,00	9,5	8,50
DDEM 110 098	110,0	98,00	9,5	8,50
DDEM 120 105	120,0	105,00	11,0	10,00
DDEM 125 110	125,0	110,00	11,0	10,00
DDEM 140 125	140,0	125,00	11,0	10,00
DDEM 150 135	150,0	135,00	11,0	10,00
DDEM 160 145	160,0	145,00	11,0	10,00
DDEM 180 160	180,0	160,00	15,0	14,00
DDEM 200 180	200,0	180,00	15,0	14,00

**Web:** <http://cat.hansa-flex.com/en/DDEM>

## DDEM P

## Piston seal, DDEM-P

Low-friction seal. Simple solution.

**Design:** Piston U-ring  
**Operating pressure:** up to 16 bar  
**Sliding speed max.:** 1,0 m/s  
**Design:** Metric  
**Temp. min.:** -30 °C  
**Temp. max.:** 80 °C  
**Media:** Air  
**Installation:** on one-piece pistons A, on multi-part pistons B  
**Material:** PUR 90° Shore A  
**Application:** Hydraulics + pneumatics

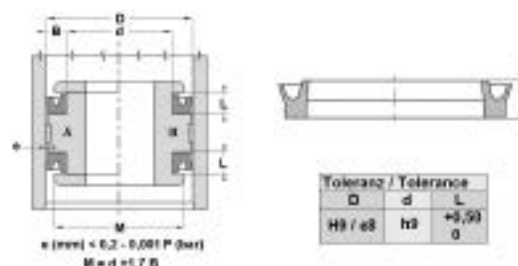

**Ordering information:** We are able to produce seals with diameters of 20 to 510 mm with short lead times.

Identification	D mm	d mm	L mm	Identification	D mm	d mm	L mm
DDEM 20 14-P	20	14	4,5	DDEM 80 68-P	80	68	9,5
DDEM 25 17-P	25	17	5,5	DDEM 85 73-P	85	73	9,5
DDEM 32 24-P	32	24	6,0	DDEM 90 78-P	90	78	9,5
DDEM 40 30-P	40	30	7,5	DDEM 000 88-P	100	88	9,5
DDEM 50 40-P	50	40	7,5	DDEM 100 95-P	110	95	11,0
DDEM 55 45-P	55	45	7,5	DDEM 201 05-P	120	105	11,0
DDEM 60 50-P	60	50	7,5	DDEM 25 110-P	125	110	11,0
DDEM 63 53-P	63	53	7,5	DDEM 60 145-P	160	145	11,0
DDEM 65 55-P	65	55	7,5	DDEM 80 160-P	180	160	15,0
DDEM 70 58-P	70	58	9,5	DDEM 00 180-P	200	180	15,0
DDEM 75 63-P	75	63	9,5				

**Web:** <http://cat.hansa-flex.com/en/DDEMP>

## DPC

## Piston packing set for split pistons DPC



Toleranz / Tolerance					
D	d	L	G	M	P
H11	+0,10	+0,25	+0,10	±0,05	±0,15
0	0	0	0	0	0

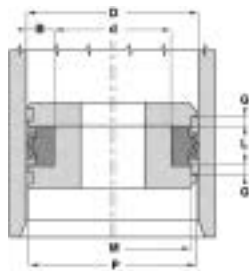

Extremely good sealing effect at low pressure. Low friction. High pressure. Simple solution.

**Design:** Piston packing set

**Operating pressure:** up to 700 bar

**Sliding speed max.:** 0,5 m/s

**Temp. min.:** -30 °C

**Temp. max.:** 110 °C

**Media:** Mineral oils, Water emulsions

**Installation:** on multi-part pistons

**Material:** (1) Seal: fabric-reinforced NBR, (2) Guide ring: acetal resin, (3) Back ring: acetal resin

**Application:** Hydraulics

**Ordering information:** For special operating conditions (fluid, temperature, pressure ...) please contact us. Alternative material possible: FPM.

Identification	D mm	d mm	L mm	G mm	M mm	P mm
DPC 40 24	40	24	18,4	6,35	35,40	38,70
DPC 45 29	45	29	18,4	6,35	40,40	43,70
DPC 50 34	50	34	18,4	6,35	45,40	48,70
DPC 55 39	55	39	18,4	6,35	50,40	53,70
DPC 60 44	60	44	18,4	6,35	55,40	58,70
DPC 65 50	65	50	18,4	6,35	60,40	63,70
DPC 70 50	70	50	22,4	6,35	64,20	68,30
DPC 75 55	75	55	22,4	6,35	69,20	73,30
DPC 80 60	80	60	22,4	6,35	74,20	78,30
DPC 85 65	85	65	22,4	6,35	79,20	83,30
DPC 90 70	90	70	22,4	6,35	84,15	88,30
DPC 95 75	95	75	22,4	6,35	89,15	93,30
DPC 100 75	100	75	22,4	6,35	93,15	98,05
DPC 100 80	100	80	25,4	6,35	94,15	98,30
DPC 105 85	105	85	22,4	6,35	98,10	103,00
DPC 110 85	110	85	22,4	6,35	103,10	108,00
DPC 120 100	120	100	25,4	6,35	114,10	118,30
DPC 140 115	140	115	25,4	6,35	133,00	138,00
DPC 150 125	150	125	25,4	6,35	143,00	148,00

**Web:** <http://cat.hansa-flex.com/en/DPC>

## DPC NEO

## Piston packing set for split pistons DPC-NEO

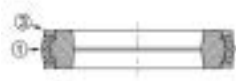

Toleranz / Tolerance					
D	d	L	G	M	P
H11	+0,10	+0,25	+0,10	±0,05	±0,15
0	0	0	0	0	0

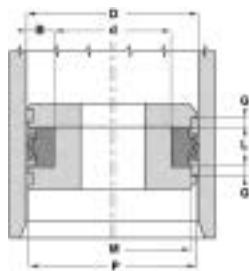

Extremely good sealing effect at low pressure. Low friction. High pressure. Simple solution.

**Operating pressure:** up to 700 bar

**Sliding speed max.:** 0,5 m/s

**Temp. min.:** -30 °C

**Temp. max.:** 110 °C

**Media:** Mineral oils, Water emulsions

**Installation:** on multi-part pistons

**Material:** (1) Seal: fabric-reinforced NBR, (3) Back ring: acetal resin

**Application:** Hydraulics

Identification	D mm	d mm	L mm	P mm
DPC 85 65-NEO	85	65	22,4	83,3
DPC 90 70-NEO	90	70	22,4	88,3
DPC 100 80-NEO	100	80	25,4	98,3
DPC 120 100-NEO	120	100	25,4	118,3

**Web:** <http://cat.hansa-flex.com/en/DPCNEO>

## Piston packing set for one-piece pistons DPS

Low-friction seal. Simple solution.

- Design:** Piston packing set  
**Operating pressure:** up to 300 bar  
**Sliding speed max.:** 0,5 m/s  
**Temp. min.:** -30 °C  
**Temp. max.:** 110 °C  
**Media:** Mineral oils, Water emulsions  
**Installation:** on one-piece or multi-part pistons  
**Material:** Seal: NBR with fabric reinforcement, Guide ring: acetal resin  
**Application:** Hydraulics

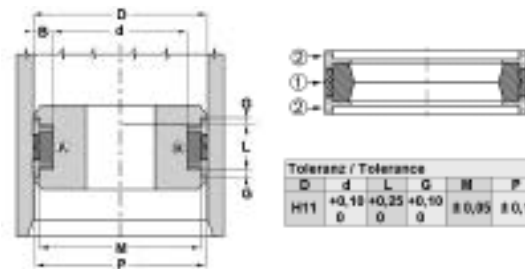

**Ordering information:** For special operating conditions (fluid, temperature, pressure ...) please contact us. Alternative material possible: FPM.

Identification	D	d	L	G	M	P	Standard grooves
	mm	mm	mm	mm	mm	mm	
DPS 25 17-1	25	17	10,0	4,00	22	24,0	ISO 5597
DPS 32 24-1	32	24	10,0	4,00	29	31,0	ISO 5597
DPS 32 24	32	24	15,5	3,20	28	31,4	
DPS 35 27	35	27	15,5	3,20	31	34,4	
DPS 40 32-1	40	32	10,0	4,00	37	39,0	ISO 5597
DPS 40 32	40	32	15,5	3,20	36	39,4	
DPS 45 37	45	37	15,5	3,20	41	44,4	
DPS 50 38	50	38	20,5	4,20	46	49,4	
DPS 50 40-1	50	40	12,5	4,00	47	49,0	ISO 5597
DPS 60 48	60	48	20,5	4,20	56	59,4	
DPS 63 51	63	51	20,5	4,20	59	62,4	
DPS 63 53-1	63	53	12,5	4,00	60	62,0	ISO 5597
DPS 65 53	65	53	20,5	4,20	61	64,4	
DPS 70 58	70	58	20,5	4,20	66	69,4	
DPS 75 63	75	63	20,5	4,20	71	74,4	
DPS 80 65-1	80	65	20,0	5,00	76	78,5	ISO 5597
DPS 80 66	80	66	22,5	5,20	76	79,4	
DPS 85 71	85	71	22,5	5,20	81	84,4	
DPS 90 76	90	76	22,5	5,20	86	89,4	
DPS 100 85-1	100	85	20,0	5,00	96	98,5	ISO 5597
DPS 100 86	100	86	22,5	5,20	96	99,4	
DPS 110 96	110	96	22,5	5,20	106	109,4	
DPS 120 106	120	106	22,5	5,20	116	119,4	
DPS 125 105-1	125	105	25,0	6,30	120	123,0	ISO 5597
DPS 125 108	125	108	26,5	7,20	121	124,4	
DPS 140 120-1	140	120	25,0	6,30	135	138,0	ISO 5597
DPS 140 123	140	123	26,5	7,20	136	139,4	
DPS 160 140-1	160	140	25,0	6,30	155	158,0	ISO 5597
DPS 160 143	160	143	26,5	7,20	156	159,4	
DPS 180 163	180	163	26,5	7,20	176	179,4	
DPS 200 170-1	200	170	36,0	12,50	192	197,0	ISO 5597
DPS 200 180	200	180	31,5	9,20	196	199,4	
DPS 220 200	220	200	31,5	9,20	216	219,4	
DPS 250 230	250	230	31,5	9,20	246	249,4	

**Web:** <http://cat.hansa-flex.com/en/DPS>

**DPS FPM**

**Piston packing set for one-piece pistons DPS-FPM**

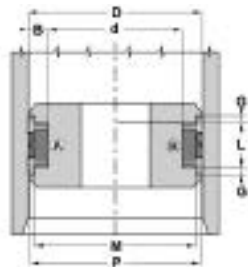

**Media:** Mineral oils, Water emulsions  
**Material:** (1) Seal: FPM, (2) Guide ring: acetal resin  
**Application:** Hydraulics

Toleranz / Tolerance					
D	d	L	G	M	P
H11	+0,10 0	+0,25 0	+0,10 0	± 0,05	± 0,15

Identification	D	d	L	G	M	P
	mm	mm	mm	mm	mm	mm
DPS 32 24-1 FPM	32	24	10,0	4,00	29,0	31,0
DPS 32 24 FPM	32	24	10,0	4,00	29,0	31,0
DPS 50 38 FPM	50	38	20,5	4,20	46,0	49,4
DPS 50 40-1 FPM	50	40	12,5	4,00	47,0	49,0
DPS 60 48 FPM	60	48	20,5	4,20	56,0	59,4
DPS 63 51 FPM	63	51	20,5	4,20	59,0	62,4
DPS 80 66 FPM	80	66	22,5	5,20	76,0	79,4
DPS 100 86 FPM	100	86	22,5	5,20	96,0	99,4
DPS 125 108 FPM	125	108	26,5	7,20	121,0	124,4
DPS 140 123 FPM	140	123	26,5	7,20	136,0	139,4

**Web:** <http://cat.hansa-flex.com/en/DPSFPM>

**DPS SI**

**Piston packing set for one-piece pistons DPS SI**

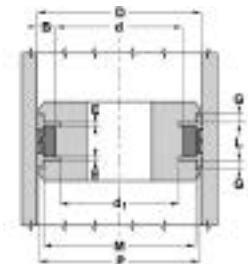

Low-friction seal. Simple solution.  
**Design:** Piston packing set  
**Operating pressure:** up to 300 bar  
**Sliding speed max.:** 0,5 m/s  
**Temp. min.:** -30 °C  
**Temp. max.:** 110 °C  
**Media:** Mineral oils, Water emulsions  
**Material:** (1) Seal: fabric-reinforced NBR, (2) Guide ring: acetal resin  
**Application:** Hydraulics

Toleranz / Tolerance					
D	d	L	G	M	P
H11	+0,10 0	+0,25 0	+0,10 0	± 0,05	± 0,15

**Ordering information:** For special operating conditions (fluid, temperature, pressure ...) please contact us. Alternative material possible: FPM.

Identification	D	d	L	G	M	P	d1	E
	mm	mm	mm	mm	mm	mm	mm	mm
DPS 30 22-SI	30	22	13,5	3,20	26	29,4	19,00	2,1
DPS 32 24-SI	32	24	15,5	3,20	28	31,4	21,00	3,1
DPS 35 27-SI	35	27	15,5	3,20	31	34,4	24,00	3,1
DPS 45 37-SI	45	37	15,5	3,20	41	44,4	34,10	3,1

**Web:** <http://cat.hansa-flex.com/en/DPSSI>

**DS**

**Piston seal DS**

Low spatial requirement. High resistance to extrusion.

- Design:** U-ring packing set
- Operating pressure:** up to 250 bar
- Sliding speed max.:** 0,5 m/s
- Temp. min.:** -40 °C
- Temp. max.:** 110 °C
- Media:** Mineral oils, Water emulsions
- Installation:** on multi-part pistons
- Material:** (1) Support ring: NBR, (2) Seal: fabric-reinforced NBR
- Application:** Hydraulics

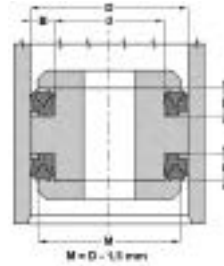

Toleranz / Tolerance			
D	d	M	L
H9 / e8	± 0,06	± 0,10	± 0,12

**Ordering information:** For special operating conditions (fluid, temperature, pressure ...) please contact us. Alternative material possible: FPM.

Identification	D	d	L	Identification	D	d	L
	mm	mm	mm		mm	mm	mm
DS 940 47	24	12	7,5	DS 314 236	80	60	13,5
DS 980 51	25	13	8,0	DS 354 275	90	70	13,5
DS 157 098	40	25	10,0	DS 374 295	95	75	13,5
DS 196 137	50	35	10,0	DS 590 492	150	125	14,0
DS 216 1571	55	40	9,5	DS 787 669	200	170	19,8
DS 216 157	55	40	12,0	DS 886 767	225	195	19,8
DS 255 177	65	45	13,5	DS 984 866	250	220	19,8
DS 275 196	70	50	13,5	DS 118 11062	300	270	19,8

**Web:** <http://cat.hansa-flex.com/en/DS>

**DS M**

**Piston seal DS-M**

Low spatial requirement. High resistance to extrusion.

- Design:** U-ring packing set
- Operating pressure:** up to 400 bar
- Sliding speed max.:** 0,5 m/s
- Temp. min.:** -40 °C
- Temp. max.:** 110 °C
- Media:** Mineral oils, Water emulsions
- Installation:** on multi-part pistons
- Material:** (2) Seal: fabric-reinforced NBR, (4) Back ring: NBR fabric laminate
- Application:** Hydraulics

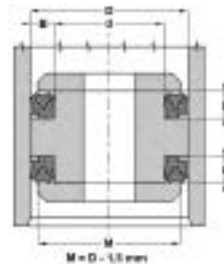

Toleranz / Tolerance			
D	d	M	L
H9 / e8	± 0,06	± 0,10	± 0,12

**Ordering information:** For special operating conditions (fluid, temperature, pressure ...) please contact us. Alternative material possible: FPM.

Identification	D	d	L	Identification	D	d	L
	mm	mm	mm		mm	mm	mm
DS 157 098-M	40	25	10,0	DS 452 354-M	115	90	16,0
DS 196 137-M	50	35	10,0	DS 452 374-M	115	95	13,0
DS 236 177-M	60	45	10,0	DS 492 393-M	125	100	16,2
DS 248 188-M	63	48	10,0	DS 551 452-M	140	115	16,2
DS 314 236-M	80	60	13,0	DS 590 472-M	150	120	19,8
DS 393 314-M	100	80	13,0	DS 629 511-M	160	130	19,8
DS 433 354-M	110	90	13,0	DS 708 590-M	180	150	19,8

**Web:** <http://cat.hansa-flex.com/en/DSM>

**DS NEO**

**Piston seal DS-NEO**

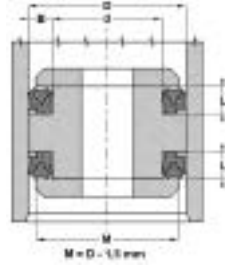

Toleranz / Tolerance			
D	d	M	L
H9 / e8	±0,06	±0,10	±0,12

Low spatial requirement. High resistance to extrusion.

- Design:** U-ring packing set
- Operating pressure:** up to 700 bar
- Sliding speed max.:** 0,5 m/s
- Temp. min.:** -40 °C
- Temp. max.:** 110 °C
- Media:** Mineral oils, Water emulsions
- Installation:** on multi-part pistons
- Material:** (1) Support ring: NBR, (2) Seal: fabric-reinforced NBR, (3) Back ring: acetal resin
- Application:** Hydraulics

**Ordering information:** For special operating conditions (fluid, temperature, pressure ...) please contact us. Alternative material possible: FPM.

Identification	D	d	L	Identification	D	d	L
	mm	mm	mm		mm	mm	mm
DS 220 157-NEO	56	40	13,5	DS 413 334-NEO	105	85	13,5
DS 248 188-NEO	63	48	10,0	DS 433 354-NEO	110	90	13,5
DS 255 177-NEO	65	45	13,5	DS 452 374-NEO	115	95	13,5
DS 275 196-NEO	70	50	13,5	DS 472 393-NEO	120	100	13,5
DS 314 236-NEO	80	60	13,5	DS 480 401-NEO	122	102	14,6
DS 334 255-NEO	85	65	13,5	DS 492 393-NEO	125	100	16,2
DS 334 275-NEO	85	70	11,6	DS 511 413-NEO	130	105	16,2
DS 354 275-NEO	90	70	13,5	DS 531 433-NEO	135	110	16,2
DS 374 295-NEO	95	75	13,5	DS 551 452-NEO	140	115	16,2
DS 393 3141-NEO	100	80	13,0	DS 590 472-NEO	150	120	18,8
DS 393 314-NEO	100	80	13,5	DS 629 511-NEO	160	130	18,0

**Web:** <http://cat.hansa-flex.com/en/DSNEO>

## Piston packing set for split pistons DSM

Extremely good sealing effect at low pressure. for difficult working conditions such as hydraulic shocks, Strong vibrations or poor surfaces.

**Design:** piston seal  
**Operating pressure:** up to 700 bar  
**Sliding speed max.:** 0,5 m/s  
**Temp. min.:** -30 °C  
**Temp. max.:** 110 °C  
**Media:** Mineral oils, Water emulsions  
**Installation:** on multi-part pistons  
**Material:** (1) Seal: NBR, (2) Guide ring: acetal resin, (3) Support ring: fabric-reinforced NBR  
**Application:** Hydraulics

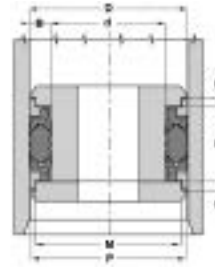

Toleranz / Tolerance					
D	d	L	G	M	P
H11	+0,12 0	+0,20 0	+0,10 0	±0,05	±0,15

**Ordering information:** For special operating conditions (fluid, temperature, pressure ...) please contact us. Alternative material possible: FPM.

Identification	D mm	d mm	L mm	G mm	M mm	P mm
DSM 216 157-1A	55,00	40,00	32,00	6,35	48,77	52,85
DSM 236 173-1A	60,00	44,00	32,00	6,35	53,80	57,80
DSM 255 192-1A	65,00	49,00	32,00	6,35	58,70	62,80
DSM 275 196-1A	70,00	50,00	35,00	9,52	62,62	67,54
DSM 295 216-1A	75,00	55,00	35,00	9,52	67,70	72,54
DSM 314 236-1A	80,00	60,00	35,00	9,52	72,62	77,52
DSM 314 251-1A	80,00	64,00	32,00	9,52	72,62	77,52
DSM 334 255-1A	85,00	65,00	35,00	9,52	77,62	82,54
DSM 354 275-1A	90,00	70,00	35,00	9,52	82,58	87,79
DSM 374 295-1A	95,00	75,00	35,00	9,52	87,60	92,50
DSM 393 314-1A	100,00	80,00	35,00	9,52	92,60	97,50
DSM 413 334-1A	105,00	85,00	35,00	9,52	97,60	102,50
DSM 433 354-1A	110,00	90,00	35,00	9,52	102,70	107,51
DSM 472 393-1A	120,00	100,00	35,00	9,52	112,80	117,51
DSM 492 393-1A	125,00	100,00	45,00	12,70	116,82	122,33
DSM 500 400-1A	127,00	101,60	44,45	12,70	118,80	124,36
DSM 511 413-1A	130,00	105,00	45,00	12,70	121,82	127,33
DSM 551 452-1A	140,00	115,00	45,00	12,70	131,72	137,30
DSM 551 472-1A	140,00	120,00	35,00	9,52	132,70	137,30
DSM 590 492-1A	150,00	125,00	45,00	12,70	141,72	147,30
DSM 629 531-1A	160,00	135,00	45,00	12,70	151,72	157,10
DSM 669 551-1A	170,00	140,00	45,00	12,70	163,00	167,87
DSM 708 610-1A	180,00	155,00	45,00	12,70	171,60	177,10
DSM 787 688-1A	200,00	175,00	45,00	12,70	191,72	197,10
DSM 826 728-1A	210,00	185,00	45,00	12,70	201,60	207,10
DSM 866 767-1A	220,00	195,00	45,00	12,70	211,60	217,10
DSM 102 4925-1A	260,00	235,00	45,00	12,70	251,72	257,10
DSM 110 21004-1A	280,00	255,00	45,00	12,70	271,72	277,10

**Web:** <http://cat.hansa-flex.com/en/DSM>

**DUM****U-ring DUM**

Toleranz / Tolerance			
d	D	L	H
H8 / f7	H9	+0,5	0

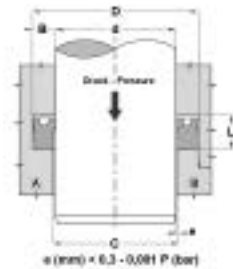

Low-friction seal. Simple solution. For rods and pistons.

<b>Design:</b>	U-ring
<b>Operating pressure:</b>	up to 120 bar
<b>Sliding speed max.:</b>	0,5 m/s
<b>Design:</b>	Metric
<b>Temp. min.:</b>	-30 °C
<b>Temp. max.:</b>	100 °C
<b>Media:</b>	Mineral oils, Water-air
<b>Installation:</b>	on one-piece pistons A, on multi-part pistons B
<b>Material:</b>	Seal: NBR 90° Shore A
<b>Application:</b>	Hydraulics + pneumatics

**Note:** Dimensions see page Rod seals ...

**Ordering information:** We are able to produce seals with diameters of 20 to 510 mm with short lead times.

**Web:** <http://cat.hansa-flex.com/en/DUMDITKOLBEN>

**DUM N****U- ring DUM-N**

Toleranz / Tolerance			
d	D	L	H
H8 / f7	H9	+0,5	0

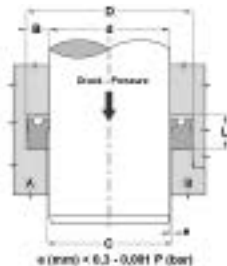

Low-friction seal. Simple solution. For rods and pistons.

<b>Design:</b>	U-ring
<b>Operating pressure:</b>	up to 120 bar
<b>Sliding speed max.:</b>	0,5 m/s
<b>Temp. min.:</b>	-30 °C
<b>Temp. max.:</b>	100 °C
<b>Media:</b>	Mineral oils, Water-air
<b>Installation:</b>	on one-piece pistons A, on multi-part pistons B
<b>Material:</b>	Seal: NBR 90° Shore A
<b>Application:</b>	Hydraulics + pneumatics

**Note:** Dimensions see page Rod seals ...

**Ordering information:** We are able to produce seals with diameters of 20 to 510 mm with short lead times.

**Web:** <http://cat.hansa-flex.com/en/DUMNDITKOLBEN>

**Product versions:**

DUM N - U- ring DUM-N, Seal: NBR 90° Shore A



EGR A

Piston packing set, EGR-A

Low spatial requirement. High extrusion resistance. low break-loose torque and dynamic friction Long service life.

- Design:** Piston packing set
- Operating pressure:** up to 700 bar
- Sliding speed max.:** 15,0 m/s
- Temp. min.:** -30 °C
- Temp. max.:** 110 °C
- Media:** Mineral oils, Water emulsions
- Installation:** on one-piece pistons A, on multi-part pistons B
- Material:** (1) Dynamic seal: PTBR, (2) Static seal: NBR
- Application:** Hydraulics

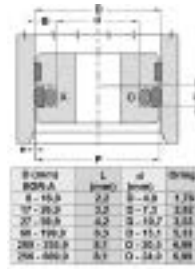

Toleranz / Tolerance					
D	d	L	G	H	P
H11	+0,12 0	+0,20 0	+0,10 0	±0,05	±0,15

Spaltmaß / Clearance			
e max			
L	0-200	200-400	400-700
2,2	0,25	0,15	f7 / H8
3,2 - 4,2	0,30	0,20	f7 / H8
6,3 - 8,1	0,40	0,25	f7 / H8

**Ordering information:** We are able to produce seals with diameters of 20 to 510 mm with short lead times.

Identification	D	d	L	Identification	D	d	L
	mm	mm	mm		mm	mm	mm
EGR 0080 A554470	8	3,1	2,2	EGR 1150 A554470	115	99,5	6,3
EGR 0100 A554470	10	5,1	2,2	EGR 1200 A554470	120	104,5	6,3
EGR 0120 A554470	12	7,1	2,2	EGR 1250 A554470	125	109,5	6,3
EGR 0150 A554470	15	7,5	3,2	EGR 1300 A554470	130	114,5	6,3
EGR 0160 A554470	16	8,5	3,2	EGR 1350 A554470	135	114,0	8,1
EGR 0200 A554470	20	12,5	3,2	EGR 1400 A554470	140	119,0	8,1
EGR 0220 A554470	22	14,5	3,2	EGR 1450 A554470	145	124,0	8,1
EGR 0240 A554470	24	16,5	3,2	EGR 1500 A554470	150	129,0	8,1
EGR 0250 A554470	25	17,5	3,2	EGR 1550 A554470	155	134,0	8,1
EGR 0280 A554470	28	20,5	3,2	EGR 1600 A554470	160	139,0	8,1
EGR 0300 A554470	30	22,5	3,2	EGR 1650 A554470	185	144,0	8,1
EGR 0320 A554470	32	24,5	3,2	EGR 1700 A554470	170	149,0	8,1
EGR 0350 A554470	35	27,5	3,2	EGR 1800 A554470	180	159,0	8,1
EGR 0360 A554470	36	28,5	3,2	EGR 1900 A554470	190	169,0	8,1
EGR 0380 A554470	38	30,5	3,2	EGR 2000 A554470	200	179,0	8,1
EGR 0400 A554470	40	29,0	4,2	EGR 2100 A554470	210	189,0	8,1
EGR 0420 A554470	42	31,0	4,2	EGR 2200 A554470	220	199,0	8,1
EGR 0440 A554470	44	33,0	4,2	EGR 2250 A554470	225	204,0	8,1
EGR 0450 A554470	45	34,0	4,2	EGR 2300 A554470	230	209,0	8,1
EGR 0480 A554470	48	37,0	4,2	EGR 2400 A554470	240	219,0	8,1
EGR 0500 A554470	50	39,0	4,2	EGR 2500 A554470	250	229,0	8,1
EGR 0520 A554470	52	41,0	4,2	EGR 2600 A554470	260	239,0	8,1
EGR 0550 A554470	55	44,0	4,2	EGR 2700 A554470	270	249,0	8,1
EGR 0560 A554470	56	45,0	4,2	EGR 2800 A554470	280	259,0	8,1
EGR 0600 A554470	60	49,0	4,2	EGR 2900 A554470	290	269,0	8,1
EGR 0600 B554470	60	44,9	6,3	EGR 3000 A554470	300	279,0	8,1
EGR 0630 A554470	63	52,0	4,2	EGR 3200 A554470	320	299,0	8,1
EGR 0650 A554470	65	54,0	4,2	EGR 3300 A554470	330	305,5	8,1
EGR 0700 A554470	70	59,0	4,2	EGR 3500 A554470	350	325,5	8,1
EGR 0750 A554470	75	64,0	4,2	EGR 3600 A554470	360	335,5	8,1
EGR 0800 A554470	80	64,5	6,3	EGR 3700 A554470	370	345,5	8,1
EGR 0850 A554470	85	69,5	6,3	EGR 3800 A554470	380	355,5	8,1
EGR 0900 A554470	90	74,5	6,3	EGR 4000 A554470	400	375,5	8,1
EGR 0950 A554470	95	79,5	6,3	EGR 4500 A554470	450	425,5	8,1
EGR 1000 A554470	100	84,5	6,3	EGR 4800 A554470	480	455,5	8,1
EGR 1050 A554470	105	89,5	6,3	EGR 5000 A554470	500	475,5	8,1
EGR 1100 A554470	110	94,5	6,3				

**Web:** <http://cat.hansa-flex.com/en/EGRA>

EGRP A

Piston packing set, EGRP

Low spatial requirement. High extrusion resistance. Long service life. low break-loose torque and dynamic friction

- Operating pressure:** up to 700 bar
- Sliding speed max.:** 0,5 m/s
- Temp. min.:** -40 °C
- Temp. max.:** 120 °C
- Media:** Mineral oils, Water emulsions
- Installation:** on one-piece or multi-part pistons
- Material:** Dynamic seal: PTFE, (2) Static seal: NBR

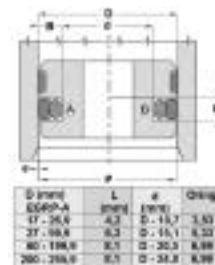

Toleranz / Tolerance					
D	d	L	G	H	P
H11	+0,12 0	+0,20 0	+0,10 0	±0,05	±0,15

Spaltmaß / Clearance			
e max			
L	0-200	200-400	400-700
2,2	0,25	0,15	f7 / H8
3,2 - 4,2	0,30	0,20	f7 / H8
6,3 - 8,1	0,40	0,25	f7 / H8

Identification	D	d	L	Identification	D	d	L
	mm	mm	mm		mm	mm	mm
EGRP 0400 A554470	40	24,5	6,3	EGRP 0900 A554470	90	69,0	8,1
EGRP 0500 A554470	50	34,5	6,3	EGRP 1000 A554470	100	79,0	8,1
EGRP 0600 A554470	60	44,5	6,3	EGRP 1100 A554470	110	89,0	8,1
EGRP 0630 A554470	63	47,5	6,3	EGRP 1200 A554470	120	99,0	8,1
EGRP 0650 A554470	65	49,5	6,3	EGRP 1250 A554470	125	104,0	8,1
EGRP 0700 A554470	70	54,5	6,3	EGRP 1300 A554470	130	109,0	8,1
EGRP 0800 A554470	80	59,0	8,1				

**Web:** <http://cat.hansa-flex.com/en/EGRPA>

**EUD**

**Piston packing set for one-piece pistons EUD**

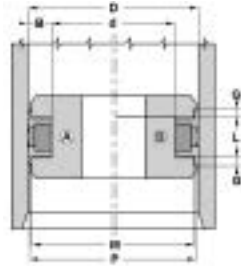

Toleranz / Tolerance					
D	d	L	G	M	P
H11	+0,12	+0,20	+0,10	±0,05	±0,15
	D	d	G		

Extremely good sealing effect at low pressure. Low spatial requirement. Easy assembly. Simple solution. High abrasion resistance.

- Design:** Piston packing set
- Operating pressure:** up to 400 bar
- Sliding speed max.:** 0,5 m/s
- Temp. min.:** -30 °C
- Temp. max.:** 80 °C
- Media:** Mineral oils
- Installation:** on one-piece pistons A, on multi-part pistons B
- Material:** (1) Dynamic seal: PUR, (2) Static seal: NBR, (3) Guide ring: acetal resin
- Application:** Hydraulics

Identification	D	d	L	G	M	P
	mm	mm	mm	mm	mm	mm
EUD 60 48	60	48	20,5	4,20	56	59,4
EUD 63 51	63	51	20,5	4,20	59	62,4
EUD 70 58	70	58	20,5	4,20	66	69,4
EUD 80 66	80	66	22,5	5,20	76	79,4
EUD 100 86	100	86	22,5	5,20	96	99,4
EUD 110 96	110	96	22,5	5,20	106	109,4
EUD 125 108	125	108	26,5	7,20	121	124,4

**Web:** <http://cat.hansa-flex.com/en/EUD>

**EUD P**

**Piston packing set for one-piece pistons EUD.P**

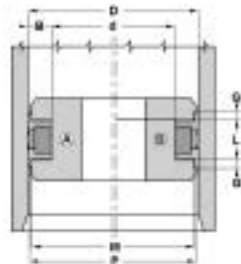

Toleranz / Tolerance					
D	d	L	G	M	P
H11	+0,12	+0,20	+0,10	±0,05	±0,15
	D	d	G		

Extremely good sealing effect at low pressure. Low spatial requirement. Easy assembly. Simple solution. High abrasion resistance.

- Design:** Piston packing set
- Operating pressure:** up to 400 bar
- Sliding speed max.:** 0,5 m/s
- Temp. min.:** -30 °C
- Temp. max.:** 80 °C
- Media:** Mineral oils
- Installation:** on one-piece pistons A, on multi-part pistons B
- Material:** (1) Dynamic seal: PUR, (3) Guide ring: acetal resin
- Application:** Hydraulics

Identification	D	d	L	G	M	P
	mm	mm	mm	mm	mm	mm
EUD 32 24-P	32	24	10,0	4,00	29	31,0
EUD 40 32-P	40	32	10,0	4,00	37	39,0
EUD 50 40-P	50	40	12,5	4,00	47	49,0
EUD 63 53-P	63	53	12,5	4,00	60	62,0
EUD 80 70-P	80	70	12,5	4,00	77	79,0

**Web:** <http://cat.hansa-flex.com/en/EUDP>

Piston packing set, GPK

Low spatial requirement. High extrusion resistance. Easy fitting without special tools. High abrasion resistance. low break-loose torque and dynamic friction. Long service life.

- Design:** Rod packing set
- Operating pressure:** up to 600 bar
- Sliding speed max.:** 1,0 m/s
- Temp. min.:** -30 °C
- Temp. max.:** 110 °C
- Media:** Mineral oils, Water emulsions
- Installation:** on one-piece pistons
- Material:** (1) Dynamic seal: PA + glass fibre, (2) Static seal: NBR
- Application:** Hydraulics

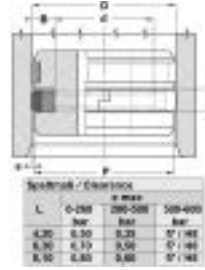

Toleranz / Tolerance		
D	d	L
H9	h9	+0,20 0

Identification	D mm	d mm	L mm
GPK 90-1	90	69,0	8,1
GPK 100-1	100	79,0	8,1
GPK 110-1	110	89,0	8,1
GPK 120-1	120	99,0	8,1
GPK 125-1	125	104,0	8,1
GPK 130-1	130	109,0	8,1

Identification	D mm	d mm	L mm
GPK 140	140	119,0	8,1
GPK 150	150	129,0	8,1
GPK 160	160	139,0	8,1
GPK 180	180	159,0	8,1
GPK 190	190	169,0	8,1
GPK 200	200	179,0	8,1

**Web:** <http://cat.hansa-flex.com/en/GPK>



**GPS**

**Piston packing set, GPS**



Toleranz / Tolerance		
D	d	L
H9	+0,1 0	+0,2 0

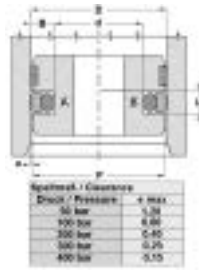

Easy assembly. Low spatial requirement. Extremely good sealing effect. High abrasion resistance.

- Design:** Piston packing set
- Operating pressure:** up to 400 bar
- Sliding speed max.:** 0,5 m/s
- Temp. min.:** -30 °C
- Temp. max.:** 80 °C
- Media:** Mineral oils
- Installation:** on one-piece pistons A, on multi-part pistons B
- Material:** (1) Dynamic seal: PUR, (2) Static seal: NBR
- Application:** Hydraulics

**Ordering information:** We are able to produce seals with diameters of 20 to 510 mm with short lead times.

Identification	D	d	L	Standard grooves	Identification	D	d	L	Standard grooves
	mm	mm	mm			mm	mm	mm	
GPS 25	25	14,0	4,2	ISO 5597	GPS 65-1	65	54,0	4,2	
GPS 25-1	25	17,5	3,2	ISO 5597	GPS 70	70	54,5	6,3	
GPS 30	30	22,5	3,2	ISO 5597	GPS 70-1	70	59,0	4,2	
GPS 32	32	21,0	4,2	ISO 5597	GPS 75	75	59,5	6,3	
GPS 32-1	32	24,5	3,2	ISO 5597	GPS 75-1	75	64,0	4,2	
GPS 35	35	27,5	3,2		GPS 80	80	64,5	6,3	
GPS 40	40	24,5	6,3		GPS 80-1	80	69,0	4,2	
GPS 40-1	40	29,0	4,2	ISO 5597	GPS 85	85	69,5	6,3	
GPS 40-2	40	32,5	3,2		GPS 90	90	74,5	6,3	
GPS 45	45	29,5	6,3		GPS 100	100	84,5	6,3	ISO 5597
GPS 45-1	45	34,0	4,2		GPS 105	105	89,5	6,3	
GPS 49	49	38,0	4,2		GPS 110	110	94,5	6,3	
GPS 50	50	34,5	6,3	ISO 5597	GPS 120	120	104,5	6,3	
GPS 50-1	50	39,0	4,2	ISO 5597	GPS 125	125	109,5	6,3	ISO 5597
GPS 55	55	39,5	6,3		GPS 130	130	114,5	6,3	
GPS 55-1	55	44,0	4,2		GPS 140	140	119,0	8,1	
GPS 60	60	44,5	6,3		GPS 150	150	129,0	8,1	
GPS 60-1	60	49,0	4,2		GPS 160	160	139,0	8,1	ISO 5597
GPS 63	63	47,5	6,3	ISO 5597	GPS 170	170	149,0	8,1	
GPS 63-1	63	52,0	4,2	ISO 5597	GPS 180	180	159,0	8,1	
GPS 65	65	49,5	6,3		GPS 200	200	179,0	8,1	ISO 5597

**Web:** <http://cat.hansa-flex.com/en/GPS>

**GPS LP**

**Piston packing set, GPS-LP**



Toleranz / Tolerance		
D	d	L
H9	+0,1 0	+0,2 0

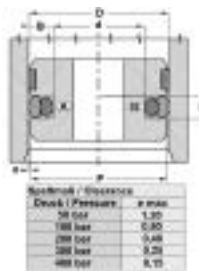

Easy assembly. Low spatial requirement. High abrasion resistance. Extremely good sealing effect.

- Operating pressure:** up to 400 bar
- Sliding speed max.:** 0,5 m/s
- Temp. min.:** -30 °C
- Temp. max.:** 80 °C
- Media:** Mineral oils
- Installation:** on one-piece pistons A, on multi-part pistons B
- Material:** (1) Dynamic seal: PUR, (2) Static seal: NBR

**Ordering information:** We are able to produce seals with diameters of 20 to 510 mm with short lead times.

Identification	D	d	L
	mm	mm	mm
GPS 35-1-LP	35,00	24,00	4,2
GPS 38-LP	38,00	30,50	3,2
GPS 130-1-LP	130,00	109,00	8,1

**Web:** <http://cat.hansa-flex.com/en/GPSLP>

MU

## U-ring MU

For rods and pistons. High abrasion resistance. Use for new designs TS, TS-L, RS-L and EU profiles (rod seals).

**Design:** U-ring

**Operating pressure:** up to 400 bar

**Sliding speed max.:** 0,5 m/s

**Temp. min.:** -30 °C

**Temp. max.:** 80 °C

**Media:** Mineral oils

**Installation:** in closed grooves A, in open grooves B, on a B or multi-part A piston

**Material:** PUR

**Application:** Hydraulics

**Note:** Dimensions see page Rod seals ...

**Ordering information:** We are able to produce seals with diameters of 20 to 510 mm with short lead times.

**Web:** <http://cat.hansa-flex.com/en/MUDITKOLBEN>

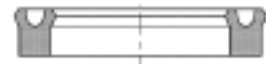
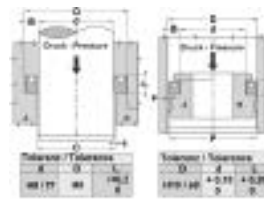

Druck bar	Spaltmaß / Clearance s [mm]	
	d < 60 mm	d > 60 mm
50	< 0,40	< 0,30
100	< 0,30	> 0,40
200	< 0,20	> 0,30
300	< 0,15	> 0,20
400	< 0,10	> 0,15

1

**PHD**

**Piston packing set for one-piece pistons PHD**



Toleranz / Tolerance		
D	d	L
H9	h9	h9
0	-0,2	0

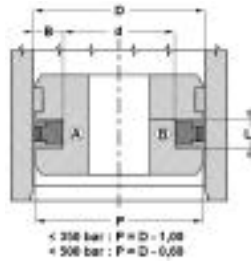

Low spatial requirement. High resistance to extrusion. High abrasion resistance. Low-friction seal.

- Design:** Piston packing set
- Operating pressure:** up to 400 bar
- Sliding speed max.:** 1,5 m/s
- Temp. min.:** 30 °C
- Temp. max.:** 110 °C
- Media:** Mineral oils, Water emulsions
- Installation:** on one-piece pistons A, on multi-part pistons B
- Material:** (1) Static seal: NBR, (2) Dynamic seal: PTBR, (3) Back ring: acetal resin
- Application:** Hydraulics

**Ordering information:** We are able to produce seals with diameters of 20 to 510 mm with short lead times.

Identification	D	d	L	Identification	D	d	L
	mm	mm	mm		mm	mm	mm
PHD 50 36	50	36	9,0	PHD 105 90	105	90	12,5
PHD 55 41	55	41	9,0	PHD 110 95	110	95	12,5
PHD 60 46	60	46	9,0	PHD 115 100	115	100	12,5
PHD 60 50	60	50	8,0	PHD 120 105	120	105	12,5
PHD 63 48	63	48	11,0	PHD 125 102	125	102	16,0
PHD 65 50	65	50	11,0	PHD 130 107	130	107	16,0
PHD 70 55	70	55	11,0	PHD 135 112	135	112	16,0
PHD 75 60	75	60	11,0	PHD 140 117	140	117	16,0
PHD 80 65	80	65	11,0	PHD 145 122	145	122	16,0
PHD 85 70	85	70	11,0	PHD 150 127	150	127	16,0
PHD 90 75	90	75	11,0	PHD 160 137	160	137	16,0
PHD 95 80	95	80	11,0	PHD 165 142	165	142	16,0
PHD 100 85	100	85	12,5	PHD 180 157	180	157	16,0

**Web:** <http://cat.hansa-flex.com/en/PHD>

**PHD PU**

**Piston packing set for one-piece pistons PHD-PU**



Toleranz / Tolerance		
D	d	L
H9	h9	h9
0	-0,2	0

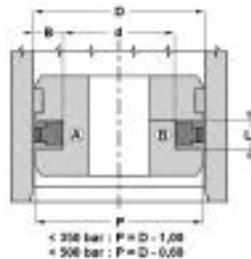

Low spatial requirement. High abrasion resistance. Low-friction seal. High resistance to extrusion.

- Design:** Piston packing set
- Operating pressure:** up to 400 bar
- Sliding speed max.:** 0,5 m/s
- Temp. min.:** 30 °C
- Temp. max.:** 80 °C
- Media:** Mineral oils, Water emulsions
- Installation:** on one-piece pistons A, on multi-part pistons B
- Material:** (1) Static seal: NBR, (2) Dynamic seal: PU, (3) Back ring: acetal resin
- Application:** Hydraulics

**Ordering information:** We are able to produce seals with diameters of 20 to 510 mm with short lead times.

Identification	D	d	L
	mm	mm	mm
PHD 100 85-PU	100	85	12,5
PHD 110 95-PU	110	95	12,5

**Web:** <http://cat.hansa-flex.com/en/PHDPU>

Piston seal RSE

High abrasion resistance. Good tightness. Simple solution.

- Design:** Piston U-ring
- Operating pressure:** up to 400 bar
- Sliding speed max.:** 0,5 m/s
- Temp. min.:** -30 °C
- Temp. max.:** 80 °C
- Media:** Mineral oils
- Installation:** on one-piece pistons A, on multi-part pistons B
- Material:** (2) Seal: PUR
- Application:** Hydraulics

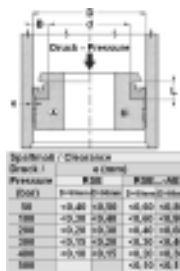

Toleranz / Tolerance		
D	d	L
H10 / +e8	+0,10	+0,20
	0	0

**Note:** The piston seals are not suitable for double-acting pistons. Please contact us.

Identification	D	d	L	M	Identification	D	d	L	M
	mm	mm	mm	mm		mm	mm	mm	mm
RSE 12 05	12,0	5,0	6,0	8	RSE 65 55-1	65,0	55,0	11,0	59
RSE 14 08	14,0	8,0	6,8	11	RSE 65 55	65,0	55,0	14,5	59
RSE 16 10-1	16,0	10,0	6,5	13	RSE 70 50	70,0	53,0	13,0	55
RSE 16 10	16,0	10,0	9,0	13	RSE 70 50-1	70,0	53,0	14,5	55
RSE 20 12	20,0	12,0	7,5	15	RSE 70 55-1	70,0	55,0	10,5	60
RSE 20 14	20,0	14,0	6,0	17	RSE 70 55	70,0	55,0	13,0	60
RSE 22 12	22,0	12,0	9,0	16	RSE 70 60	70,0	60,0	8,0	64
RSE 25 15	25,0	15,0	9,0	19	RSE 70 60-1	70,0	60,0	13,0	64
RSE 30 15	30,0	15,0	11,0	19	RSE 70 60-2	70,0	60,0	14,5	64
RSE 30 20	30,0	20,0	9,0	24	RSE 70 62	70,0	62,0	8,5	65
RSE 30 22	30,0	22,0	7,0	25	RSE 72 58	72,0	58,0	13,0	62
RSE 32 22	32,0	22,0	11,0	26	RSE 75 50	75,0	50,0	15,0	55
RSE 32 26	32,0	26,0	6,0	28	RSE 75 55	75,0	55,0	14,5	60
RSE 35 20	35,0	20,0	11,0	25	RSE 75 65-4	75,0	65,0	8,0	69
RSE 35 25	35,0	25,0	9,0	29	RSE 75 65-2	75,0	65,0	11,0	69
RSE 37 21	37,0	21,0	13,0	25	RSE 75 65	75,0	65,0	14,5	69
RSE 40 25-1	40,0	25,0	10,0	30	RSE 80 60	80,0	60,0	13,0	65
RSE 40 25	40,0	25,0	11,0	30	RSE 80 60-1	80,0	60,0	14,5	65
RSE 40 30-1	40,0	30,0	7,5	34	RSE 80 65	80,0	65,0	13,0	70
RSE 40 30	40,0	30,0	11,0	34	RSE 80 70	80,0	70,0	8,0	74
RSE 40 32-2	40,0	32,0	6,5	36	RSE 80 70-1	80,0	70,0	13,0	74
RSE 40 32	40,0	32,0	9,0	36	RSE 80 72	80,0	72,0	13,0	75
RSE 40 33	40,0	33,0	9,0	36	RSE 85 65-2	85,0	65,0	13,0	70
RSE 42 32	42,0	32,0	11,0	36	RSE 90 70	90,0	70,0	13,0	75
RSE 42 35	42,0	34,5	4,7	37	RSE 90 70-1	90,0	70,0	14,5	75
RSE 45 29	45,0	38,5	13,0	33	RSE 90 75	90,0	75,0	13,0	80
RSE 45 30	45,0	30,0	11,0	35	RSE 90 80-2	90,0	80,0	5,5	84
RSE 50 30	50,0	30,0	13,0	35	RSE 90 80-1	90,0	80,0	11,0	84
RSE 50 32	50,0	32,0	11,0	35	RSE 90 80	90,0	80,0	14,0	84
RSE 50 35-1	50,0	35,0	9,5	40	RSE 100 80-2	100,0	80,0	11,0	85
RSE 50 35	50,0	35,0	11,0	40	RSE 100 80	100,0	80,0	13,0	85
RSE 50 40-1	50,0	40,0	5,5	44	RSE 100 80-1	100,0	80,0	14,5	85
RSE 50 40	50,0	40,0	11,0	44	RSE 100 85	100,0	85,0	13,0	90
RSE 50 42-2	50,0	42,0	6,0	45	RSE 100 86	100,0	86,0	13,0	90
RSE 50 42-1	50,0	42,0	9,0	45	RSE 100 90	100,0	90,0	8,0	94
RSE 50 42	50,0	42,0	11,0	45	RSE 100 90-1	100,0	90,0	11,5	94
RSE 51 41	50,8	40,8	8,0	45	RSE 110 90	110,0	90,0	13,0	95
RSE 55 40	55,0	40,0	11,0	45	RSE 110 95	110,0	95,0	13,0	100
RSE 60 40	60,0	40,0	13,0	45	RSE 110 100	110,0	100,0	8,0	104
RSE 60 40-1	60,0	40,0	14,5	45	RSE 110 100-1	110,0	100,0	14,5	104
RSE 60 45	60,0	45,0	11,0	50	RSE 115 100	115,0	100,0	11,5	105
RSE 60 50	60,0	50,0	8,0	54	RSE 115 105	115,0	105,0	14,5	109
RSE 60 50-2	60,0	50,0	11,0	54	RSE 120 100	120,0	100,0	13,0	105
RSE 60 52	60,0	52,0	9,0	55	RSE 120 100-1	120,0	100,0	14,5	105
RSE 63 43	63,0	43,0	13,0	47	RSE 125 105	125,0	100,0	13,0	110
RSE 63 45	63,0	45,0	11,0	50	RSE 125 105-1	125,0	100,0	16,0	110
RSE 63 45-2	63,0	45,0	13,0	50	RSE 125 115	125,0	115,0	8,0	119
RSE 63 48-1	63,0	48,0	11,0	53	RSE 125 115-1	125,0	115,0	16,0	119
RSE 63 48	63,0	48,0	13,0	53	RSE 140 120	140,0	120,0	13,0	125
RSE 63 53	63,0	53,0	8,0	57	RSE 150 125	150,0	125,0	14,5	130
RSE 63 53-1	63,0	53,0	13,0	57	RSE 150 130	150,0	130,0	16,0	135
RSE 65 45-1	65,0	45,0	13,0	50	RSE 160 140	160,0	140,0	14,5	145
RSE 65 45	65,0	45,0	14,5	50	RSE 180 160	180,0	160,0	14,5	165
RSE 65 50	65,0	50,0	11,0	55	RSE 280 250	280,0	250,0	19,0	256

**Web:** <http://cat.hansa-flex.com/en/RSE>

## RSE AE

### Piston seal RSE-AE

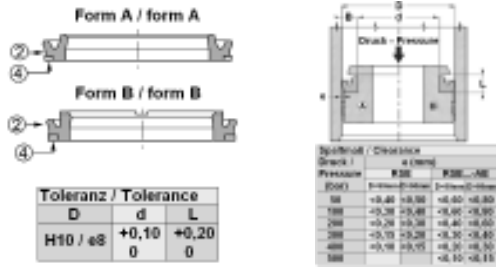

High abrasion resistance. Good tightness. Simple solution.

- Design:** Piston U-ring
- Operating pressure:** up to 500 bar
- Sliding speed max.:** 0,5 m/s
- Temp. min.:** -30 °C
- Temp. max.:** 80 °C
- Media:** Mineral oils
- Installation:** on one-piece pistons A, on multi-part pistons B
- Material:** (2) Seal: PUR, (2) Support ring: acetal resin / PTBR
- Application:** Hydraulics

**Note:** The piston seals are not suitable for double-acting pistons. Please contact us.

Identification	D	d	L	Profile	Standard grooves
	mm	mm	mm		
RSE 40 25-AE	40	25	9,5	B	ISO 5597
RSE 50 35-AE	50	35	9,5	B	ISO 5597
RSE 60 45-AE	60	45	9,5	A	ISO 5597
RSE 63 48-AE	63	48	9,5	B	ISO 5597
RSE 70 50-AE	70	50	12,5	A	
RSE 80 60-AE	80	60	12,5	B	ISO 5597
RSE 90 70-AE	90	70	12,5	B	ISO 5597
RSE 100 80-AE	100	80	12,5	B	ISO 5597
RSE 110 90-AE	110	90	12,5	B	ISO 5597
RSE 125 100-AE	125	100	15,5	B	ISO 5597
RSE 140 115-AE	140	115	15,5	A	ISO 5597
RSE 140 120-AE	140	120	12,5	B	
RSE 160 140-AE	160	140	12,5	B	
RSE 200 170-AE	200	170	19,0	A	ISO 5597
RSE 200 175-AE	200	175	16,0	A	

**Web:** <http://cat.hansa-flex.com/en/RSEAE>

## RSE W

### Piston seal RSE-W

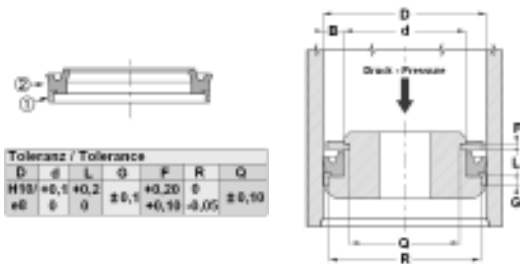

High abrasion resistance. Good tightness. Simple solution.

- Design:** Piston U-ring
- Operating pressure:** up to 400 bar
- Sliding speed max.:** 0,5 m/s
- Temp. min.:** -30 °C
- Temp. max.:** 80 °C
- Media:** Mineral oils
- Installation:** on one-piece pistons
- Material:** (1) Guide ring: acetal resin, (2) Seal: PUR
- Application:** Hydraulics

**Ordering information:** We are able to produce seals with diameters of 20 to 510 mm with short lead times.

Identification	D	d	L	G	R
	mm	mm	mm	mm	mm
RSE 32 20-W	32	20	9,0	6,35	28,50
RSE 40 25-W	40	25	9,5	6,35	35,40
RSE 45 35-W	45	35	9,5	6,35	40,40
RSE 60 40-W	60	40	14,5	6,35	55,40
RSE 65 50-W	65	50	11,0	6,35	60,40
RSE 70 50-W	70	50	14,5	6,35	64,20
RSE 80 60-W1	80	60	14,5	6,35	74,15
RSE 90 70-W1	90	70	14,5	6,35	84,15
RSE 100 80-W	100	80	14,5	6,35	93,15

**Web:** <http://cat.hansa-flex.com/en/RSEW>



## RSE W-AR

## Piston seal RSE-W-AR

High abrasion resistance. Good tightness. Simple solution.

**Design:** Piston U-ring

**Operating pressure:** up to 400 bar

**Sliding speed max.:** 0,5 m/s

**Temp. min.:** -30 °C

**Temp. max.:** 80 °C

**Media:** Mineral oils

**Installation:** on one-piece pistons

**Material:** (1) Guide ring: acetal resin, (2) Seal: PUR, (3) Seeger ring: acetal resin

**Application:** Hydraulics

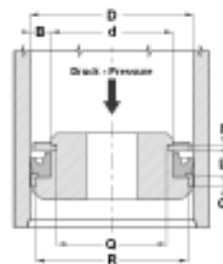

Toleranz / Tolerance							
D	d	L	G	F	R	Q	
H18/+0,1	+0,2		±0,1	+0,20	±	±0,10	
e8	g	0		+0,10/-0,05			

**Ordering information:** We are able to produce seals with diameters of 20 to 510 mm with short lead times.

Identification	D	d	L	G	F	R	Q
	mm	mm	mm	mm	mm	mm	mm
RSE 40 26-W-AR	40	26	9,4	6,35	3,1	35,40	21,60
RSE 63 45-W-AR	63	45	10,5	6,35	3,1	58,40	40,84

**Web:** <http://cat.hansa-flex.com/en/RSEWAR>

## TDO

## Complete piston TDO



Toleranz / Tolerance		
D	d	E
H11	f8	± 0,50

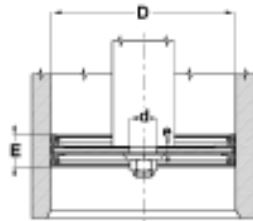

Complete pistons.

**Design:** Complete pistons**Operating pressure:** up to 40 bar**Sliding speed max.:** 0,5 m/s**Temp. min.:** -30 °C**Temp. max.:** 110 °C**Media:** Mineral oils, Water-air**Installation:** push onto piston recess with the rubber side and affix with washer and nut.**Material:** NBR 85° Shore A, with steel core**Application:** Hydraulics

**Ordering information:** For special operating conditions (fluid, temperature, pressure ...) please contact us. Alternative material possible: FPM.

Identification	D	d	P	E	e
	mm	mm	mm	mm	mm
TDO 26	26	8,2	15,0	22	3,0
TDO 30	30	8,2	16,0	22	3,0
TDO 35	35	8,2	20,0	26	3,0
TDO 40	10	10,2	20,0	22	3,0
TDO 45	45	10,2	22,0	25	4,0
TDO 50	50	10,2	27,0	25	4,0
TDO 55	55	10,2	32,0	25	4,0
TDO 60	60	12,2	37,0	26	4,0
TDO 63	63	12,2	40,0	25	4,0
TDO 70	70	12,2	44,0	30	5,0
TDO 80	80	12,2	54,0	30	5,0
TDO 100	100	12,2	72,0	35	6,0
TDO 110	110	12,2	78,0	40	6,0
TDO 115	115	20,2	83,0	30	8,0
TDO 125	125	20,2	85,0	40	8,0
TDO 140	140	20,2	100,0	40	10,0
TDO 150	150	20,2	105,0	40	10,0
TDO 200	200	20,2	146,0	40	10,0
TDO 250	250	30,2	200,0	40	12,0
TDO 300	300	35,2	250,0	40	12,0

**Web:** <http://cat.hansa-flex.com/en/TDO>

## TDO FPM

## Complete piston TDOP FPM

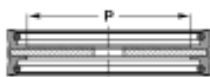

Toleranz / Tolerance		
D	d	E
H11	f8	± 0,50

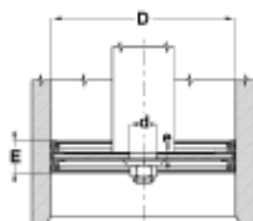
**Design:** Complete pistons**Application:** Hydraulics

Identification	D	d	P	E	e
	mm	mm	mm	mm	mm
TDO 080 FPM	80	12,2	54	30	5,0
TDO 100 FPM	100	12,2	72	35	6,0

**Web:** <http://cat.hansa-flex.com/en/TDOFPM>

## Ice scraper DR

Low spatial requirement. Effective wiping under extreme conditions. Suitable for ice, sludge and especially sticky particles. The floating metallic wiper lip allows the rods to be offset.

**Design:** Wipers

**Sliding speed max.:** 1,0 m/s

**Temp. min.:** -40 °C

**Temp. max.:** 120 °C

**Media:** Mineral oils, Water-air

**Installation:** is pressed into an open groove

**Material:**

(1) Metallic wiper lip: brass (INOX optional), (2) Elastomer wiper lip: NBR (FPM optional), (3) Sleeve: steel (INOX optional), (4) Distance pieces: steel (INOX optional)

**Application:** Hydraulics

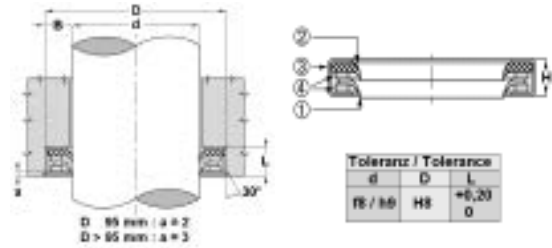

Identification	d	D	L	H
	mm	mm	mm	mm
DR 14	14	27	7,0	6,5
DR 16	16	29	7,0	6,5
DR 20	20	33	7,0	6,5
DR 22	22	35	7,0	6,5
DR 25	25	38	7,0	6,5
DR 28	28	41	7,0	6,5
DR 30	30	43	7,5	7,0
DR 35	35	48	7,5	7,0
DR 36	36	49	7,5	7,0
DR 38	38	51	7,5	7,0
DR 40	40	53	7,5	7,0

Identification	d	D	L	H
	mm	mm	mm	mm
DR 45	45	58	7,5	7,0
DR 50	50	64	8,0	7,5
DR 50-R-9975-R	50	64	8,0	7,5
DR 55	55	69	8,0	7,5
DR 60	60	74	8,0	7,5
DR 70	70	84	8,0	7,5
DR 75	75	89	8,0	7,5
DR 80	80	96	8,5	8,0
DR 90	90	106	8,5	8,0
DR 150	150	170	9,0	8,5

**Web:** <http://cat.hansa-flex.com/en/DR>

## DSR

## Wiper DSR



Toleranz / Tolerance			
d	D	C	L
H11	H11	H11	+0,20 ø

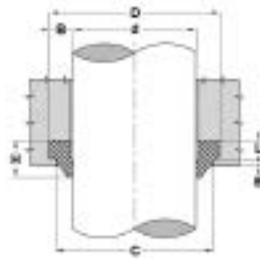

Easy assembly.

**Design:** Wipers**Sliding speed max.:** 0,5 m/s**Temp. min.:** -30 °C**Temp. max.:** 110 °C**Media:** Mineral oils, Water emulsions**Installation:** bend the wiper into a kidney shape and press into the locating groove**Material:** NBR**Application:** Hydraulics**Ordering information:** Alternative material possible: FPM.

Identification	d	D	L	C	E
	mm	mm	mm	mm	mm
DSR 4	4	12	4,0	10	1,0
DSR 8	8	16	4,0	14	1,0
DSR 10	10	18	4,0	16	1,0
DSR 12	12	20	4,0	18	1,0
DSR 14	14	22	4,0	20	1,0
DSR 15	15	23	4,0	21	1,0
DSR 16	16	24	4,0	22	1,0
DSR 18	18	26	4,0	24	1,0
DSR 20	20	28	4,0	26	1,0
DSR 22	22	30	4,0	28	1,0
DSR 24	24	32	4,0	30	1,0
DSR 25	25	33	4,0	31	1,0
DSR 28	28	36	4,0	34	1,0
DSR 30	30	38	4,0	36	1,0
DSR 32	32	40	4,0	38	1,0
DSR 35	35	43	4,0	41	1,0
DSR 36	36	44	4,0	42	1,0
DSR 38	38	46	4,0	44	1,0
DSR 40	40	48	4,0	46	1,0
DSR 42	42	50	4,0	48	1,0
DSR 45	45	53	4,0	51	1,0
DSR 48	48	56	4,0	54	1,0
DSR 50	50	58	4,0	56	1,0
DSR 52	52	60	4,0	58	1,0
DSR 55	55	63	4,0	61	1,0
DSR 56	56	64	4,0	62	1,0
DSR 60	60	68	4,0	66	1,0
DSR 62	62	70	4,0	68	1,0
DSR 63	63	71	4,0	69	1,0
DSR 65	65	73	4,0	71	1,0
DSR 70	70	78	4,0	76	1,0
DSR 75	75	83	4,0	81	1,0
DSR 80	80	88	4,0	86	1,0
DSR 85	85	93	4,0	91	1,0
DSR 90	90	98	4,0	96	1,0
DSR 95	95	103	4,0	101	1,0
DSR 100	100	108	4,0	106	1,0
DSR 105	105	117	5,5	114	1,5
DSR 110	110	122	5,5	119	1,5
DSR 120	120	132	5,5	129	1,5
DSR 125	125	137	5,5	134	1,5
DSR 130	130	142	5,5	139	1,5
DSR 140	140	152	5,5	149	1,5
DSR 150	150	162	5,5	159	1,5
DSR 160	160	172	5,5	169	1,5
DSR 170	170	182	5,5	179	1,5
DSR 180	180	192	5,5	189	1,5
DSR 190	190	202	5,5	199	1,5
DSR 200	200	212	5,5	209	1,5
DSR 220	220	235	6,5	231	2,0
DSR 250	250	265	6,5	261	2,0

**Web:** <http://cat.hansa-flex.com/en/DSR>

## DSR FPM

## Wiper DSR-FPM

Easy assembly.

**Design:** Wipers  
**Sliding speed max.:** 0,5 m/s  
**Temp. min.:** -30 °C  
**Temp. max.:** 110 °C  
**Media:** Mineral oils, Water emulsions  
**Installation:** bend the wiper into a kidney shape and press into the locating groove  
**Material:** FPM  
**Application:** Hydraulics

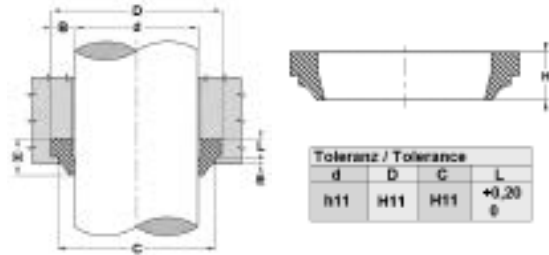

Identification	d	D	L	C	E
	mm	mm	mm	mm	mm
DSR 100 FPM	100	108	4,0	106	1,0
DSR 18 FPM	18	26	4,0	24	1,0

**Web:** <http://cat.hansa-flex.com/en/DSRFPM>

## DSR-P

## Wiper DSR-P

Easy assembly. High abrasion resistance.

**Design:** Wipers  
**Sliding speed max.:** 0,5 m/s  
**Temp. min.:** -30 °C  
**Temp. max.:** 80 °C  
**Media:** Mineral oils  
**Installation:** bend the wiper into a kidney shape and press into the locating groove  
**Material:** PUR  
**Application:** Hydraulics

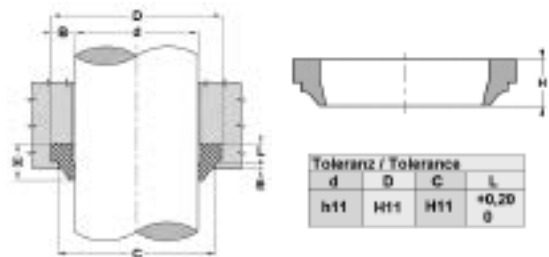

Identification	d	D	L	C	E
	mm	mm	mm	mm	mm
DSR-P 12	12	20	4,0	18	1,0
DSR-P 16	16	24	4,0	22	1,0
DSR-P 18	18	26	4,0	24	1,0
DSR-P 20	20	28	4,0	26	1,0
DSR-P 22	22	30	4,0	28	1,0
DSR-P 25	25	33	4,0	31	1,0
DSR-P 28	28	36	4,0	34	1,0
DSR-P 30	30	38	4,0	36	1,0
DSR-P 32	32	40	4,0	38	1,0
DSR-P 35	35	43	4,0	41	1,0
DSR-P 36	36	44	4,0	42	1,0
DSR-P 40	40	48	4,0	46	1,0
DSR-P 42	42	50	4,0	48	1,0
DSR-P 45	45	53	4,0	51	1,0
DSR-P 50	50	58	4,0	56	1,0
DSR-P 55	55	63	4,0	61	1,0
DSR-P 56	56	65	4,0	62	1,0
DSR-P 60	60	68	4,0	66	1,0
DSR-P 63	63	71	4,0	69	1,0
DSR-P 65	65	73	4,0	71	1,0
DSR-P 70	70	78	4,0	76	1,0
DSR-P 75	75	83	4,0	81	1,0
DSR-P 80	80	88	4,0	86	1,0
DSR-P 85	85	93	4,0	91	1,0
DSR-P 90	90	98	4,0	96	1,0
DSR-P 95	95	103	4,0	101	1,0
DSR-P 100	100	108	4,0	106	1,0
DSR-P 110	110	122	5,5	119	1,5
DSR-P 120	120	132	5,5	129	1,5
DSR-P 125	125	137	5,5	134	1,5
DSR-P 130	130	142	5,5	139	1,5
DSR-P 135	135	147	5,5	144	1,5
DSR-P 140	140	152	5,5	149	1,5

**Web:** <http://cat.hansa-flex.com/en/DSRP>

**DSR U**

**Double wiper DSR-U**

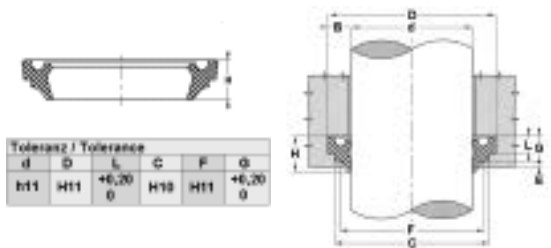

Toleranz / Tolerance					
d	D	L	C	F	G
h11	H11	+6,20 0	H18	H11	+6,20 0

Easy assembly.

- Design:** Wipers
- Sliding speed max.:** 0,5 m/s
- Temp. min.:** -30 °C
- Temp. max.:** 110 °C
- Media:** Mineral oils, Water emulsions
- Installation:** bend the wiper into a kidney shape and press into the locating groove
- Application:** Hydraulics
- Material:** NBR

Identification	D	d	L	C	F	G	E	H
	mm	mm	mm	mm	mm	mm	mm	mm
DSR 10-U	18	10	4,0	16	13,5	6,0	2	8
DSR 12-U	20	12	4,0	18	15,5	6,0	2	8
DSR 14-U	22	14	4,0	20	17,5	6,0	2	8
DSR 15-U	23	15	4,0	21	18,5	6,0	2	8
DSR 16-U	24	16	4,0	22	19,5	6,0	2	8
DSR 18-U	26	18	4,0	24	21,5	6,0	2	8
DSR 20-U	28	20	4,0	26	23,5	6,0	2	8
DSR 22-U	30	22	4,0	28	25,5	6,0	2	8
DSR 24-U	32	24	4,0	30	27,5	6,0	2	8
DSR 25-U	33	25	4,0	31	28,5	6,0	2	8
DSR 28-U	36	28	4,0	34	31,5	6,0	2	8
DSR 30-U	38	30	4,0	36	33,5	6,0	2	8
DSR 32-U	40	32	4,0	38	35,5	6,0	2	8
DSR 35-U	43	35	4,0	41	38,5	6,0	2	8
DSR 36-U	44	36	4,0	42	39,5	6,0	2	8
DSR 37-U	45	37	4,0	43	40,5	6,0	2	8
DSR 38-U	46	38	4,0	44	41,5	6,0	2	8
DSR 40-U	48	40	4,0	46	43,5	6,0	2	8
DSR 42-U	50	42	4,0	48	45,5	6,0	2	8
DSR 45-U	53	45	4,0	51	48,5	6,0	2	8
DSR 46-U	54	46	4,0	52	49,5	6,0	2	8
DSR 48-U	56	48	4,0	54	51,5	6,0	2	8
DSR 50-U	58	50	4,0	56	53,5	6,0	2	8
DSR 55-U	63	55	4,0	61	58,5	6,0	2	8
DSR 56-U	64	56	4,0	62	59,5	6,0	2	8
DSR 60-U	68	60	4,0	66	63,5	6,0	2	8
DSR 63-U	71	63	4,0	69	66,5	6,0	2	8
DSR 65-U	73	65	4,0	71	68,5	6,0	2	8
DSR 70-U	78	70	4,0	76	73,5	6,0	2	8
DSR 75-U	83	75	4,0	81	78,5	6,0	2	8
DSR 80-U	88	80	4,0	86	83,5	6,0	2	8
DSR 85-U	93	85	4,0	91	88,5	6,0	2	8
DSR 90-U	98	90	4,0	96	93,5	6,0	2	8
DSR 100-U	108	100	4,0	106	103,5	6,0	2	8
DSR 110-U	122	110	5,5	119	115,0	8,2	3	11
DSR 125-U	137	125	5,5	134	130,0	8,2	3	11
DSR 130-U	142	130	5,5	139	135,0	8,2	3	11
DSR 140-U	152	140	5,5	149	145,0	8,2	3	11
DSR 145-U	157	145	5,5	154	150,0	8,2	3	11
DSR 150-U	162	150	5,5	159	155,0	8,2	3	11
DSR 160-U	172	160	5,5	169	165,0	8,2	3	11
DSR 200-U	212	200	5,5	209	205,0	8,2	3	11
DSR 220-U	235	220	6,5	231	227,0	9,5	3	13
DSR 360-U	375	360	6,5	371	367,0	9,5	3	13

**Web:** <http://cat.hansa-flex.com/en/DSRU>

**DSR U FPM**

**Double wiper DSR-U-FPM**

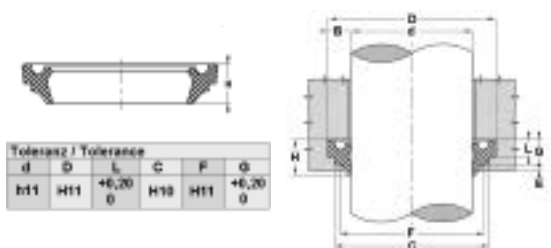

Toleranz / Tolerance					
d	D	L	C	F	G
h11	H11	+6,20 0	H18	H11	+6,20 0

Easy assembly.

- Design:** Wipers
- Sliding speed max.:** 0,5 m/s
- Temp. min.:** -30 °C
- Temp. max.:** 110 °C
- Media:** Mineral oils, Water emulsions
- Installation:** bend the wiper into a kidney shape and press into the locating groove
- Application:** Hydraulics
- Material:** FPM

Identification	D	d	E	L	C
	mm	mm	mm	mm	mm
DSR 56-U FPM	64	56	1,0	4,0	62

**Web:** <http://cat.hansa-flex.com/en/DSRUFPM>

## DSR UP

## Double wiper DSR-UP

Also wipes off leak oil from seal chamber. Easy assembly.

- Design:** Wipers  
**Sliding speed max.:** 0,5 m/s  
**Temp. min.:** -30 °C  
**Temp. max.:** 80 °C  
**Media:** Mineral oils  
**Installation:** bend the wiper into a kidney shape and press into the locating groove  
**Application:** Hydraulics  
**Material:** PUR

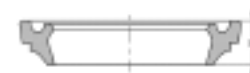
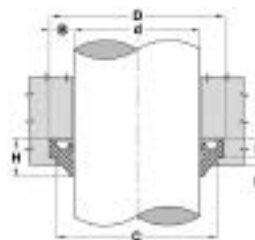

Toleranz / Tolerance					
d	D	L	C	F	G
h11	H11	+0,20 0	H10	H11	+0,20 0

Identification	D	d	L	C	F	G	E	H
	mm	mm	mm	mm	mm	mm	mm	mm
DSR 18-UP	26	18	4,0	24	21,5	6,0	2	8
DSR 22-UP	22	22	4,0	28	25,5	6,0	2	8
DSR 32-UP	40	32	4,0	38	35,5	6,0	2	8
DSR 35-UP	43	35	4,0	41	38,5	6,0	2	8
DSR 36-UP	44	36	4,0	42	39,5	6,0	2	8
DSR 40-UP	48	40	4,0	46	43,5	6,0	2	8
DSR 45-UP	53	45	4,0	51	48,5	6,0	2	8
DSR 50-UP	58	50	4,0	56	53,5	6,0	2	8
DSR 55-UP	63	55	4,0	61	58,5	6,0	2	8
DSR 56-UP	64	56	4,0	62	59,5	6,0	2	8
DSR 60-UP	68	60	4,0	66	63,5	6,0	2	8
DSR 63-UP	71	63	4,0	69	66,5	6,0	2	8
DSR 80-UP	88	80	4,0	86	83,5	6,0	2	8
DSR 90-UP	98	90	4,0	96	93,5	6,0	2	8
DSR 100-UP	108	100	4,0	106	103,5	6,0	2	8

**Web:** <http://cat.hansa-flex.com/en/DSRUP>

## GA

## Wiper GA

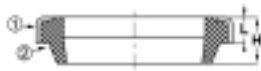

Toleranz / Tolerance		
d	D	L
h11	H8	+0,25 g

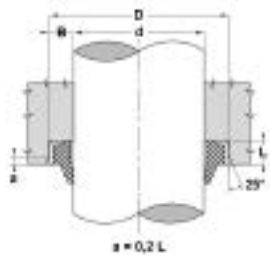

Low spatial requirement. No penetration of dirt via the outer metal ring.  
Simple solution.

**Design:** Wipers  
**Sliding speed max.:** 0,5 m/s  
**Temp. min.:** -30 °C  
**Temp. max.:** 100 °C  
**Media:** Mineral oils, Water emulsions  
**Installation:** is pressed into an open groove  
**Material:** (1) Sleeve: Steel, (2) Wiper: NBR 90° Shore A  
**Application:** Hydraulics

**Ordering information:** For special operating conditions (fluid, temperature, pressure ...) please contact us. Alternative material possible: FPM.

Identification	d mm	D mm	L mm	H mm	Standard grooves
GA 10 16-3	10	16,0	3,0	4,5	
GA 10 19-3	10	18,9	2,9	5,0	
GA 10 20-5	10	20,0	5,0	8,0	
GA 12 18-3	12	18,0	3,5	5,0	
GA 12 20-4	12	20,0	4,0	6,0	
GA 12 22-5	12	22,0	5,0	8,0	
GA 14 20-3	14	20,0	3,0	4,5	
GA 14 22-3	14	22,0	3,0	4,0	
GA 16 22-3	16	22,0	3,0	4,0	
GA 16 26-5	16	26,0	5,0	8,0	
GA 18 28-5	18	28,0	5,0	7,0	
GA 18 28-7	18	28,0	7,0	10,0	ISO 5597
GA 20 26-3	20	26,0	3,5	5,0	
GA 20 28-3	20	28,0	3,5	5,0	
GA 20 28-5	20	28,0	5,0	7,0	
GA 20 30-4	20	30,0	4,0	6,0	
GA 20 30-5	20	30,0	5,0	8,0	
GA 20 30-7	20	30,0	7,0	10,0	ISO 5597
GA 20 35-7	20	35,0	7,0	10,0	
GA 22 28-5	22	28,0	5,0	9,0	
GA 22 30-4	22	30,0	4,0	7,0	
GA 22 32-5	22	32,0	5,0	7,0	
GA 22 32-7	22	32,0	7,0	10,0	ISO 5597
GA 22 35-5	22	35,0	5,0	8,0	
GA 25 35-5	25	35,0	5,0	8,0	
GA 25 35-7	25	35,0	7,0	10,0	ISO 5597
GA 28 38-5	28	38,0	5,0	8,0	
GA 28 38-7	28	38,0	7,0	10,0	
GA 28 40-7	28	40,0	7,0	10,0	
GA 30 40-5	30	40,0	5,0	8,0	
GA 30 40-7	30	40,0	7,0	10,0	
GA 30 45-5	30	45,0	5,0	8,0	
GA 32 40-4	32	40,0	4,0	7,0	
GA 32 42-5	32	42,0	5,0	7,0	
GA 32 42-7	32	42,0	7,0	10,0	
GA 32 45-4	32	45,0	4,0	8,0	
GA 32 45-7	32	45,0	7,0	10,0	
GA 33 43-5	33	43,0	5,0	8,0	
GA 35 45-5	35	45,0	5,0	8,0	
GA 35 45-7	35	45,0	7,0	10,0	ISO 5597
GA 35 47-7	35	47,0	7,0	10,0	
GA 36 45-7	36	45,0	7,0	10,0	
GA 36 46-5	36	46,0	5,0	8,0	
GA 38 48-7	38	48,0	7,0	10,0	
GA 40 50-5	40	50,0	5,0	8,0	
GA 40 50-7	40	50,0	7,0	10,0	ISO 5597
GA 40 52-5	40	52,0	5,0	8,0	
GA 42 52-7	42	52,0	7,0	10,0	
GA 45 55-7	45	55,0	7,0	10,0	ISO 5597
GA 45 60-7	45	60,0	7,0	10,0	
GA 48 60-7	48	60,0	7,0	10,0	
GA 50 56-5	50	56,0	5,0	8,0	
GA 50 60-5	50	60,0	5,0	8,0	
GA 50 60-7	50	60,0	7,0	10,0	ISO 5597
GA 50 65-5	50	65,0	5,0	8,0	
GA 50 65-7	50	65,0	7,0	10,0	
GA 52 62-7	52	62,0	7,0	10,0	
GA 55 63-7	55	63,0	7,0	10,0	
GA 55 65-7	55	65,0	7,0	10,0	
GA 55 70-7	55	70,0	7,0	10,0	
GA 55 80-5	55	80,0	5,0	8,0	
GA 56 65-7	56	65,0	7,0	10,0	
GA 56 66-5	56	66,0	5,0	8,0	
GA 56 66-7	56	66,0	7,0	10,0	ISO 5597
GA 60 70-5	60	70,0	5,0	7,0	
GA 60 70-7	60	70,0	7,0	10,0	
GA 60 74-5	60	74,0	5,0	8,0	
GA 60 75-7	60	75,0	7,0	10,0	
GA 63 75-7	63	75,0	7,0	10,0	
GA 63 83-5	63	83,0	5,0	8,0	
GA 65 75-7	65	75,0	7,0	10,0	
GA 70 80-5	70	80,0	5,0	7,0	
GA 70 80-7	70	80,0	7,0	10,0	ISO 5597
GA 75 85-7	75	85,0	7,0	10,0	





(Continued)

GA

Wiper GA

Identification	d mm	D mm	L mm	H mm	Standard grooves
GA 75 87-5	75	87,0	5,0	7,0	
GA 80 90-7	80	90,0	7,0	10,0	ISO 5597
GA 85 95-7	85	95,0	7,0	10,0	
GA 90 100-5	90	100,0	5,0	7,0	
GA 90 100-7	90	100,0	7,0	10,0	ISO 5597
GA 95 105-7	95	105,0	7,0	10,0	
GA 100 110-5	100	110,0	5,0	7,0	
GA 100 110-7	100	110,0	7,0	10,0	
GA 105 115-7	105	115,0	7,0	10,0	
GA 110 120-7	110	120,0	7,0	10,0	
GA 115 125-7	115	125,0	7,0	10,0	
GA 120 130-7	120	130,0	7,0	10,0	
GA 125 140-7	125	140,0	7,0	10,0	
GA 125 140-9	125	140,0	9,0	12,0	ISO 5597
GA 130 145-9	130	145,0	9,0	12,0	
GA 135 145-7	135	145,0	7,0	10,0	
GA 135 150-9	135	150,0	9,0	12,0	
GA 140 150-7	140	150,0	7,0	10,0	
GA 140 155-9	140	155,0	9,0	12,0	ISO 5597
GA 150 165-9	150	165,0	9,0	12,0	
GA 160 175-9	160	175,0	9,0	12,0	ISO 5597
GA 170 185-10	170	185,0	10,0	14,0	
GA 180 195-10	180	195,0	10,0	14,0	
GA 200 220-12	200	220,0	12,0	16,0	

Web: <http://cat.hansa-flex.com/en/GA>

GA FPM

Wiper GA-FPM

Low spatial requirement. No penetration of dirt via the outer metal ring.  
Simple solution.

- Design:** Wipers
- Sliding speed max.:** 0,5 m/s
- Temp. min.:** -20 °C
- Temp. max.:** 200 °C
- Media:** Mineral oils, Water emulsions
- Installation:** is pressed into an open groove
- Material:** (1) Sleeve: Steel, Wiper: FPM
- Application:** Hydraulics

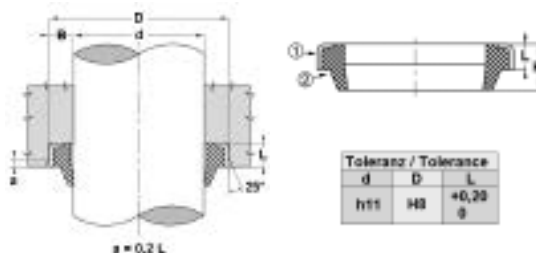

**Ordering information:** For special operating conditions (fluid, temperature, pressure ...) please contact us.

Identification	d mm	D mm	L mm	H mm	Identification	d mm	D mm	L mm	H mm
GA 16 22-3 FPM	16	22	3,0	4	GA 45 60-7 FPM	45	60	7,0	10
GA 25 35-7 FPM	25	35	7,0	10	GA 50 56-5 FPM	50	56	5,0	8
GA 30 40-7 FPM	30	40	7,0	10	GA 60 70-7 FPM	60	70	7,0	10
GA 32 45-4 FPM	32	45	4,0	8	GA 63 75-7 FPM	63	75	7,0	10
GA 45 55-7 FPM	45	55	7,0	10	GA 70 80-7 FPM	70	80	7,0	10

Web: <http://cat.hansa-flex.com/en/GAFPM>

GAR ABS

Wiper GA-R

Low spatial requirement. No penetration of dirt via the outer metal ring.  
Simple solution.

- Design:** Wipers
- Sliding speed max.:** 0,5 m/s
- Temp. min.:** -30 °C
- Temp. max.:** 100 °C
- Media:** Mineral oils, Water emulsions
- Installation:** is pressed into an open groove
- Material:** (1) Sleeve: Steel, (2) Wiper: NBR 90° Shore A
- Application:** Hydraulics

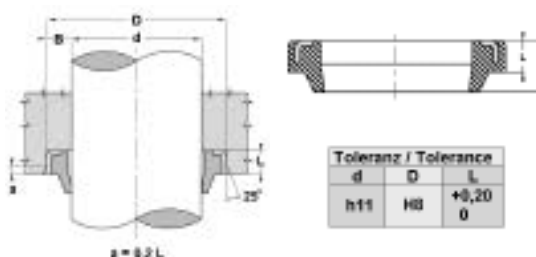

**Ordering information:** For special operating conditions (fluid, temperature, pressure ...) please contact us. Alternative material possible: FPM.

Identification	d mm	D mm	L mm	H mm	Identification	d mm	D mm	L mm	H mm
GA 12 18-3-R	12	18,0	3,5	5,0	GA 16 22-3-R	16	22,0	3,5	5,0
GA 14 20-3-R	14	20,0	3,5	5,0	GA 18 28-5-R	18	28,0	5,0	7,0
GA 15 21-3-R	15	21,0	3,5	5,0	GA 20 30-5-R	20	30,0	5,0	7,0

## GAR ABS

(Continued)

## Wiper GA-R

Identification	d mm	D mm	L mm	H mm
GA 22 32-5-R	22	32,0	5,0	7,0
GA 25 35-5-R	25	35,0	5,0	7,0
GA 28 38-5-R	28	38,0	5,0	7,0
GA 30 40-5-R	30	40,0	5,0	7,0
GA 30 40-7-R	30	40,0	7,0	10,0
GA 32 42-5-R	32	42,0	5,0	7,0
GA 36 46-5-R	36	46,0	5,0	7,0
GA 40 50-5-R	40	50,0	5,0	8,0
GA 42 52-5-R	42	52,0	5,0	7,0
GA 45 55-5-R	45	55,0	5,0	7,0

Identification	d mm	D mm	L mm	H mm
GA 50 60-5-R	50	60,0	5,0	7,0
GA 55 65-5-R	55	65,0	5,0	7,0
GA 56 66-5-R	56	66,0	5,0	7,0
GA 60 70-5-R	60	70,0	5,0	7,0
GA 63 73-5-R	63	73,0	5,0	7,0
GA 65 75-5-R	65	75,0	5,0	7,0
GA 70 80-5-R	70	80,0	5,0	7,0
GA 75 83-7-R	75	83,0	7,0	10,0
GA 80 88-7-R	80	88,0	7,0	10,0
GA 80 90-7-R	80	90,0	7,0	10,0

**Web:** <http://cat.hansa-flex.com/en/GARABS>

NW

## Wiper NW

Easy assembly. Simple solution. High abrasion resistance.

**Design:** Wipers  
**Sliding speed max.:** 4,0 m/s  
**Temp. min.:** -30 °C  
**Temp. max.:** 110 °C  
**Media:** Mineral oils  
**Installation:** press wiper into the locating groove  
**Material:** Wiper: PA + MoS2  
**Application:** Hydraulics

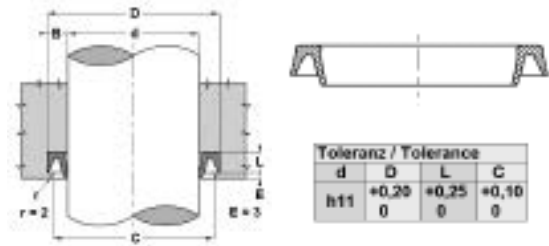

Identification	d mm	D mm	L mm	C mm
NW 500	12,70	22,22	4,4	20,62
NW 16	16,00	26,00	4,5	24,50
NW 750	19,05	31,75	6,0	30,15
NW 20	20,00	33,00	6,0	31,50
NW 875	22,22	34,92	6,0	33,32
NW 25	25,00	38,00	6,0	36,50
NW 1000	25,40	38,10	6,0	36,50
NW 1125	28,57	41,27	6,0	99,70
NW 1250	31,80	44,45	6,0	72,29

Identification	d mm	D mm	L mm	C mm
NW 1500	38,10	50,80	6,0	49,20
NW 1750	44,45	57,15	6,0	52,37
NW 50	50,00	63,00	6,0	61,50
NW 2000	50,80	63,50	6,0	61,90
NW 2500	63,50	76,20	6,0	74,60
NW 2750	69,85	82,55	6,0	80,65
NW 70	70,00	83,00	6,0	81,50
NW 3000	76,20	88,90	6,0	87,30

**Web:** <http://cat.hansa-flex.com/en/NW>

## PPW

## Piston wiper PPW

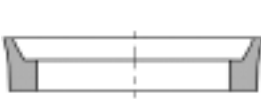

Toleranz / Tolerance			
D	d	E	P
H11	+0,10 0	+0,25 0	± 0,10

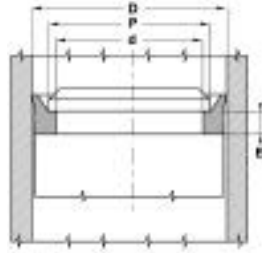

Easy assembly. Simple solution. High abrasion resistance.

**Design:** Piston wiper  
**Sliding speed max.:** 0,5 m/s  
**Temp. min.:** -30 °C  
**Temp. max.:** 80 °C  
**Media:** Mineral oils  
**Installation:** on one-piece pistons  
**Material:** PUR

**Ordering information:** We are able to produce wipers with diameters of 20 to 510 mm with short lead times.

Identification	d mm	D mm	E mm	P mm
PPW 040	31,4	40	5,3	37
PPW 050	41,4	50	5,3	47
PPW 060	51,4	60	5,3	57
PPW 063	54,4	63	5,3	60
PPW 075	66,4	75	5,3	72
PPW 080	71,4	80	5,3	77
PPW 090	81,4	90	5,3	87
PPW 095	86,4	95	5,3	92
PPW 100	91,4	100	5,3	97
PPW 110	101,4	110	5,3	107
PPW 115	106,4	115	5,3	112
PPW 125	116,4	125	5,3	122
PPW 140	131,4	140	5,3	137

**Web:** <http://cat.hansa-flex.com/en/PPW>

## PW G

## Wiper PW-G

Low spatial requirement. High abrasion resistance. Simple solution.

**Sliding speed max.:** 0,8 m/s

**Temp. min.:** -30 °C

**Temp. max.:** 80 °C

**Media:** Mineral oils

**Installation:** is pressed into an open groove

**Material:** (1) Sleeve: Steel, (2) Wiper: PUR

**Application:** Hydraulics

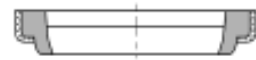
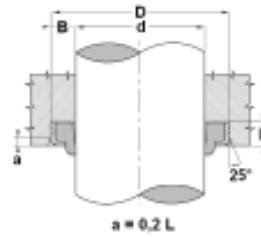

Toleranz / Tolerance		
d	D	L
h11	H8	+0,20 0

Identification	d mm	D mm	L mm
PW 8-1G	8	14	3,5
PW 10-2G	10	16	3,5
PW 10-1G	10	20	5,0
PW 12-3G	12	18	3,5
PW 12-2G	12	20	4,0
PW 12-1G	12	22	5,0
PW 14-2G	14	20	3,5
PW 14-G	14	22	4,5
PW 14-1G	14	25	3,5
PW 15-2G	15	21	3,5
PW 16-2G	16	22	3,0
PW 16-1G	16	26	5,0
PW 18-G	18	26	4,5
PW 18-2G	18	28	5,0
PW 20-2G	20	30	4,0
PW 20-3G	20	30	5,0
PW 20-1G	20	30	7,0
PW 22-2G	22	28	5,0
PW 22-3G	22	32	5,0
PW 22-1G	22	32	7,0
PW 25-2G	25	32	5,0
PW 25-3G	25	35	5,0
PW 28-3G	28	38	5,0
PW 28-2G	28	38	7,0
PW 28-1G	28	40	7,0
PW 30-3G	30	40	5,0
PW 30-1G	30	40	7,0
PW 30-2G	30	45	5,0
PW 32-4G	32	42	5,0
PW 32-3G	32	42	7,0
PW 32-2G	32	45	4,0
PW 33-1G	33	43	7,0
PW 35-1G	35	45	7,0
PW 36-1G	36	45	7,0
PW 38-1G	38	48	7,0

Identification	d mm	D mm	L mm
PW 40-2G	40	50	5,0
PW 42-2G	42	52	5,0
PW 42-1G	42	52	7,0
PW 45-3G	45	55	5,0
PW 45-2G	45	55	7,0
PW 45-G	45	57	7,0
PW 45-1G	45	60	7,0
PW 50-2G	50	60	5,0
PW 50-1G	50	60	7,0
PW 55-2G	55	65	5,0
PW 55-1G	55	65	7,0
PW 56-2G	56	66	5,0
PW 56-1G	56	66	7,0
PW 60-4G	60	70	5,0
PW 60-1G	60	70	7,0
PW 60-3G	60	74	5,0
PW 63-2G	63	73	5,0
PW 63-1G	63	75	7,0
PW 65-2G	65	75	5,0
PW 65-1G	65	75	7,0
PW 70-2G	70	80	5,0
PW 70-1G	70	80	7,0
PW 75-2G	75	83	7,0
PW 75-1G	75	85	7,0
PW 80-2G	80	88	7,0
PW 80-1G	80	90	7,0
PW 90-1G	90	100	7,0
PW 95-1G	95	105	7,0
PW 100-1G	100	110	7,0
PW 100-G	100	114	8,0
PW 105-1G	105	115	7,0
PW 110-1G	110	120	7,0
PW 110-G	110	124	8,0
PW 120-1G	120	130	7,0

**Web:** <http://cat.hansa-flex.com/en/PWG>

## PW U

## Wiper PW-U

Low spatial requirement. High abrasion resistance. Simple solution.

**Sliding speed max.:** 0,5 m/s

**Temp. min.:** -30 °C

**Temp. max.:** 80 °C

**Media:** Mineral oils

**Installation:** is pressed into an open groove

**Material:** (1) Sleeve: Steel, (2) Wiper: PUR

**Application:** Hydraulics

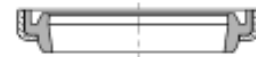
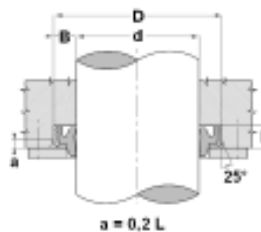

Toleranz / Tolerance		
d	D	L
h11	H8	+0,20 0

Identification	d mm	D mm	L mm
PW 20-U	20	32	6,0
PW 22-U	22	34	6,0
PW 25-U	25	37	6,0
PW 30-U	30	42	6,0
PW 35-U	35	47	7,0
PW 40-U	40	52	7,0
PW 45-U	45	57	7,0
PW 50-U	50	62	7,0
PW 55-U	55	69	8,0
PW 60-U	60	74	8,0
PW 65-U	65	79	8,0

Identification	d mm	D mm	L mm
PW 70-U	70	84	8,0
PW 75-U	75	89	8,0
PW 80-U	80	94	8,0
PW 85-U	85	99	8,0
PW 90-U	90	104	8,0
PW 95-U	95	109	8,0
PW 100-U	100	114	8,0
PW 105-U	105	121	9,0
PW 110-U	110	126	9,0
PW 120-U	120	136	9,0

**Web:** <http://cat.hansa-flex.com/en/PWU>

**SWP**

**Wiper SWP**

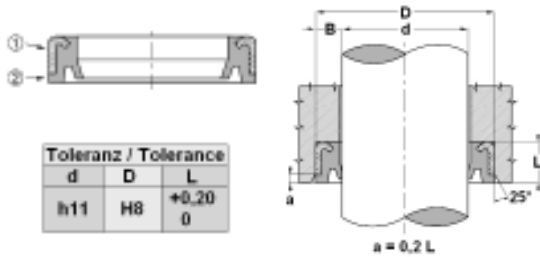

Low spatial requirement. High abrasion resistance. For earth-moving equipment and difficult working conditions.

- Design:** Wipers
- Sliding speed max.:** 0,5 m/s
- Temp. min.:** -30 °C
- Temp. max.:** 80 °C
- Media:** Mineral oils
- Installation:** is pressed into an open groove
- Design:** Metric
- Material:** (1) Sleeve: Steel, (2) Wiper: PUR
- Application:** Hydraulics

Identification	d mm	D mm	L mm
SWP 25 38	25,0	38,0	7,5
SWP 30 40	30,0	40,0	4,0
SWP 30 43	30,0	43,0	7,5
SWP 35 45	35,0	45,0	4,0
SWP 35 50	35,0	50,0	7,5
SWP 36 48	36,0	48,0	6,0
SWP 38 50	38,0	50,0	7,5
SWP 40 50	40,0	50,0	4,0
SWP 40 52	40,0	52,0	6,0
SWP 45 55	45,0	55,0	4,0
SWP 45 60	45,0	60,0	7,5
SWP 50 60	50,0	60,0	4,0
SWP 50 65	50,0	65,0	7,5
SWP 55 65	55,0	65,0	3,2
SWP 55 68	55,0	68,0	4,0
SWP 55 70	55,0	70,0	7,5
SWP 56 70	56,0	70,0	7,5
SWP 60 70	60,0	70,0	7,0
SWP 60 75-1	60,0	75,0	4,0
SWP 60 75	60,0	75,0	7,5
SWP 63 78	63,0	78,0	7,5
SWP 65 80-1	65,0	80,0	5,0
SWP 65 80	65,0	80,0	7,5
SWP 70 80	70,0	80,0	5,0
SWP 70 84	70,0	84,0	7,5
SWP 70 85-1	70,0	85,0	4,0

Identification	d mm	D mm	L mm
SWP 70 85	70,0	85,0	7,5
SWP 71 86	71,0	86,0	5,0
SWP 75 90	75,0	90,0	7,5
SWP 75 95	75,0	95,0	10,0
SWP 76 96	76,5	96,5	10,0
SWP 80 94	80,0	94,0	8,0
SWP 80 95-1	80,0	95,0	5,0
SWP 80 95	80,0	95,0	7,5
SWP 80 100	80,0	100,0	10,0
SWP 85 100	85,0	100,0	10,0
SWP 85 105	85,0	105,0	10,0
SWP 90 104	90,0	104,0	8,0
SWP 90 105	90,0	105,0	6,0
SWP 90 110	90,0	110,0	10,0
SWP 95 115	95,0	115,0	10,0
SWP 100 115-2	100,0	115,0	4,0
SWP 100 115-1	100,0	115,0	6,5
SWP 100 115	100,0	115,0	7,5
SWP 100 120	100,0	120,0	10,0
SWP 105 120	105,0	120,0	7,5
SWP 110 125	110,0	125,0	9,0
SWP 110 130	110,0	130,0	10,0
SWP 115 130	115,0	130,0	7,5
SWP 120 140	120,0	140,0	10,0
SWP 130 145	130,0	145,0	7,5
SWP 160 175	160,0	175,0	10,0

Web: <http://cat.hansa-flex.com/en/SWP>

**SWP-I**

**Wiper SWP-I**

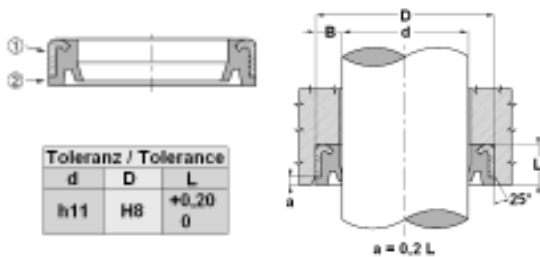

Low spatial requirement. High abrasion resistance. For earth-moving equipment and difficult working conditions.

- Design:** Wipers
- Sliding speed max.:** 0,5 m/s
- Temp. min.:** -30 °C
- Temp. max.:** 80 °C
- Media:** Mineral oils
- Installation:** is pressed into an open groove
- Design:** Inches
- Material:** (1) Sleeve: Steel, (2) Wiper: PUR
- Application:** Hydraulics

Identification	d mm	D mm	L mm
SWP-I 075 125	19,05	31,75	6,30
SWP-I 100 150	25,40	38,10	8,00
SWP-I 112 162	28,57	41,27	8,00
SWP-I 125 175	31,75	44,45	6,30
SWP-I 137 187	34,92	47,62	8,00
SWP-I 150 187	38,10	47,62	6,30
SWP-I 150 200	38,10	50,80	6,30
SWP-I 150 225	38,10	57,15	9,50
SWP-I 162 212	41,27	53,97	6,30
SWP-I 175 225	44,45	57,15	6,30
SWP-I 175 212	44,45	53,90	4,80
SWP-I 200 250	50,80	63,50	7,93
SWP-I 200 262	50,80	66,67	6,30

Identification	d mm	D mm	L mm
SWP-I 200 275	50,80	69,85	9,50
SWP-I 225 275	57,15	69,85	6,30
SWP-I 225 287	57,15	73,02	6,30
SWP-I 250 300	63,50	76,20	7,92
SWP-I 250 325	63,50	82,55	9,50
SWP-I 275 325	69,82	82,55	8,00
SWP-I 275 375	69,85	95,25	12,70
SWP-I 300 350	76,20	88,90	7,92
SWP-I 325 375-1	82,55	95,25	7,92
SWP-I 325 375	82,55	95,25	9,50
SWP-I 325 425	82,55	107,95	12,70
SWP-I 350 450	88,90	114,30	12,70

Web: <http://cat.hansa-flex.com/en/SWPI>

## UWR

## Rod seal UWR

Easy assembly. Also wipes off leak oil from seal chamber.

**Design:** Double wiper seal  
**Sliding speed max.:** 0,5 m/s  
**Temp. min.:** -30 °C  
**Temp. max.:** 110 °C  
**Media:** Mineral oils, Water  
**Installation:** bend the wiper into a kidney shape and press into the locating groove  
**Material:** NBR  
**Application:** Hydraulics

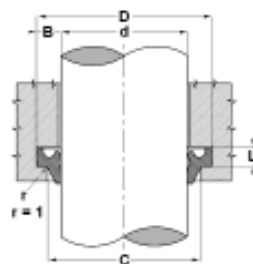

Toleranz / Tolerance			
d	D	L	C
H11	+0,20 0	+0,10 0	+0,20 0

**Ordering information:** For special operating conditions (fluid, temperature, pressure ...) please contact us. We are able to produce wipers with diameters of 20 to 510 mm with short lead times. Alternative material possible: FPM.

Identification	D	d	L	C	Identification	D	d	L	C
	mm	mm	mm	mm		mm	mm	mm	mm
UWR 470 80	20,6	12,0	5,3	15,0	UWR 165 196	50,0	42,0	5,3	45,0
UWR 620 87	22,6	16,0	3,8	19,0	UWR 177 208	53,6	45,0	5,3	48,0
UWR 781 10	28,6	20,0	5,3	23,0	UWR 255 287	73,6	65,0	5,3	68,0
UWR 118 149	38,6	30,0	5,3	33,0	UWR 260 292	74,6	66,0	5,3	69,0
UWR 137 169	43,6	35,0	5,3	38,0	UWR 301 348	88,7	76,5	7,1	82,5
UWR 157 188	48,6	40,0	5,3	43,0	UWR 307 362	92,2	78,0	7,1	85,0

**Web:** <http://cat.hansa-flex.com/en/UWR>

## UWR-P

## Rod seal UWR-P

Easy assembly. Also wipes off leak oil from seal chamber.

**Design:** Double wiper seal  
**Sliding speed max.:** 0,5 m/s  
**Temp. min.:** -30 °C  
**Temp. max.:** 80 °C  
**Media:** Mineral oils  
**Installation:** bend the wiper into a kidney shape and press into the locating groove  
**Material:** PUR  
**Application:** Hydraulics

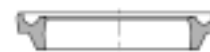
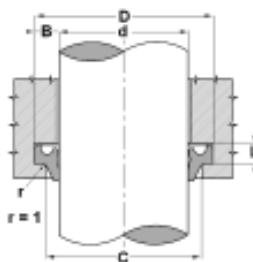

Toleranz / Tolerance			
d	D	L	C
h11	+0,20 0	+0,10 0	+0,20 0

Identification	d	D	L	C	Identification	d	D	L	C
	mm	mm	mm	mm		mm	mm	mm	mm
UWR-P 12	12	18,6	3,8	15,0	UWR-P 50-1	50	50,0	5,0	53,0
UWR-P 18	18	24,6	3,8	21,0	UWR-P 50	50	58,6	5,3	53,0
UWR-P 20	20	28,6	5,3	23,0	UWR-P 55	55	63,6	5,3	58,0
UWR-P 22	22	30,6	5,3	25,0	UWR-P 56	56	64,6	5,3	59,0
UWR-P 24	24	32,6	5,3	27,0	UWR-P 60	60	68,6	5,3	63,0
UWR-P 25-1	25	25,0	4,0	27,5	UWR-P 63	63	71,6	5,3	66,0
UWR-P 25	25	33,6	5,3	28,0	UWR-P 65	65	73,6	5,3	68,0
UWR-P 28-1	28	28,0	5,0	31,0	UWR-P 70	70	78,6	5,3	73,0
UWR-P 28	28	36,6	5,3	31,0	UWR-P 75	75	83,6	5,3	78,0
UWR-P 30	30	38,6	5,3	33,0	UWR-P 80	80	88,6	5,3	83,0
UWR-P 32	32	40,6	5,3	35,0	UWR-P 85	85	97,2	7,1	91,0
UWR-P 35-1	35	35,0	5,0	38,0	UWR-P 90-1	90	90,0	6,0	93,0
UWR-P 35	35	43,6	5,3	38,0	UWR-P 90	90	102,2	7,1	96,0
UWR-P 36	36	44,6	5,3	39,0	UWR-P 100	100	112,2	7,1	106,0
UWR-P 40	40	48,6	5,3	43,0	UWR-P 110	110	122,2	7,1	116,6
UWR-P 45	45	53,6	5,3	48,0					

**Web:** <http://cat.hansa-flex.com/en/UWRP>

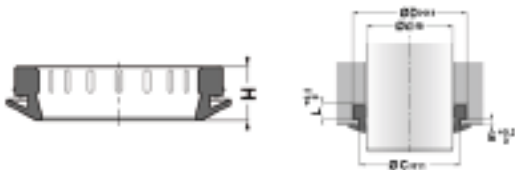
**WAH****Wiper, WAH**

<b>Design:</b>	Wipers
<b>Sliding speed max.:</b>	4,0 m/s
<b>Temp. min.:</b>	-40 °C
<b>Temp. max.:</b>	110 °C
<b>Media:</b>	Mineral oil
<b>Installation:</b>	bend the wiper into a kidney shape and press into the locating groove
<b>Application:</b>	For the usage at higher pollution, for e.g.; Mining, foundries
<b>Material:</b>	PU 93° Shore A

Identification	C mm	D mm	d mm	E mm	H mm	L mm
WAH-35	42,0	45,0	35	1,5	10,0	6,3
WAH-36	41,5	44,0	36	1,5	8,0	5,0
WAH-40	45,5	48,0	40	1,5	8,0	5,0
WAH-45	50,5	53,0	45	1,5	8,0	5,0
WAH-50	55,5	58,0	50	1,5	8,0	5,0
WAH-56	63,0	66,0	56	1,5	10,0	6,3
WAH-60	67,0	70,0	60	1,5	10,0	6,3
WAH-63	70,0	73,0	63	1,5	10,0	6,3
WAH-70	78,4	82,6	70	2,0	12,0	8,0
WAH-80	87,0	90,0	80	1,5	10,0	6,3
WAH-90	96,0	102,2	90	2,8	12,4	7,1

**Web:** <http://cat.hansa-flex.com/en/WAH>

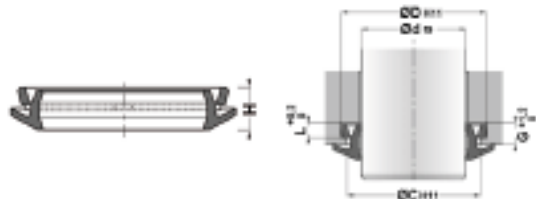
**WUH****Wiper, WUH**

<b>Design:</b>	Wipers
<b>Sliding speed max.:</b>	4,0 m/s
<b>Temp. min.:</b>	-40 °C
<b>Temp. max.:</b>	110 °C
<b>Media:</b>	Mineral oil
<b>Installation:</b>	bend the wiper into a kidney shape and press into the locating groove
<b>Application:</b>	For the usage at higher pollution, for e.g.; Mining, foundries
<b>Material:</b>	PU 93° Shore A

Identification	C mm	D mm	d mm	G mm	H mm	L mm
WUH-26	32,0	34,0	26	5,00	8,7	4,0
WUH-30	36,0	38,0	30	5,00	8,7	4,0
WUH-32	38,0	40,0	32	5,00	8,7	4,0
WUH-36	42,0	44,0	36	5,00	8,7	4,0
WUH-40	46,0	48,0	40	5,00	8,7	4,0
WUH-45	51,0	53,0	45	5,00	8,7	4,0
WUH-50	56,0	58,0	50	5,00	8,7	4,0
WUH-52	58,0	60,0	52	5,00	8,7	4,0
WUH-56	62,0	64,0	56	5,00	8,7	4,0
WUH-60	66,0	68,0	60	5,00	8,7	4,0
WUH-68	74,0	76,0	68	5,00	8,7	4,0
WUH-70	76,0	78,0	70	5,00	8,7	4,0
WUH-75	81,0	83,0	75	5,00	8,7	4,0
WUH-80	86,0	88,0	80	5,00	8,7	4,0
WUH-100	107,0	110,0	100	8,10	11,7	6,3

**Web:** <http://cat.hansa-flex.com/en/WUH>



WRM

Wiper WRM

Easy assembly. Simple solution. Low spatial requirement.

- Design:** Wipers
- Sliding speed max.:** 0,5 m/s
- Temp. min.:** -30 °C
- Temp. max.:** 110 °C
- Media:** Mineral oils, Water emulsions
- Installation:** bend the wiper into a kidney shape and press into the locating groove
- Material:** NBR 90° Shore A
- Application:** Hydraulics

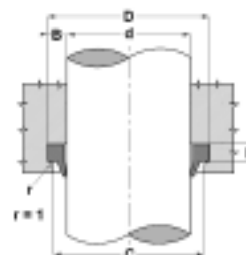

Toleranz / Tolerance			
d	D	L	C
h11	+0,20 0	+0,10 0	+0,20 0

**Ordering information:** Alternative material possible: FPM.

Identification	d	D	L	C	Identification	d	D	L	C
	mm	mm	mm	mm		mm	mm	mm	mm
WRM 470 70	12,0	18,6	3,8	15,0	WRM 295 345	75,0	87,2	7,1	81,0
WRM 510 74	13,0	19,6	3,8	16,0	WRM 301 348	76,5	88,7	7,1	82,5
WRM 590 82	15,0	21,6	3,8	18,0	WRM 307 362	78,0	92,2	7,1	85,0
WRM 620 87	16,0	22,6	3,8	19,0	WRM 314 346	80,0	88,6	5,3	83,0
WRM 700 94	18,0	24,6	3,8	21,0	WRM 314 362	80,0	92,2	7,1	86,0
WRM 781 10	20,0	28,6	5,3	23,0	WRM 334 366	85,0	93,6	5,3	88,0
WRM 861 18	22,0	30,6	5,3	25,0	WRM 346 393	88,0	100,2	7,1	94,0
WRM 981 29	25,0	33,6	5,3	28,0	WRM 354 401	90,0	102,2	7,1	96,0
WRM 102 133	26,0	34,6	5,3	29,0	WRM 374 421	95,0	107,2	7,1	101,0
WRM 106 137	27,0	35,6	5,3	30,0	WRM 393 440	100,0	112,2	7,1	106,0
WRM 110 141	28,0	36,6	5,3	31,0	WRM 413 460	105,0	117,2	7,1	111,0
WRM 118 149	30,0	38,6	5,3	33,0	WRM 433 480	110,0	122,2	7,1	116,0
WRM 125 157	32,0	40,6	5,3	35,0	WRM 452 500	115,0	127,2	7,1	121,0
WRM 137 169	35,0	43,6	5,3	38,0	WRM 472 504	120,0	128,0	7,0	123,0
WRM 141 173	36,0	44,6	5,3	39,0	WRM 472 519	120,0	132,2	7,1	126,0
WRM 157 188	40,0	48,6	5,3	43,0	WRM 492 539	125,0	137,2	7,1	131,0
WRM 165 196	42,0	50,6	5,3	45,0	WRM 492 551	125,0	140,2	10,1	132,0
WRM 177 208	45,0	53,6	5,3	48,0	WRM 531 578	135,0	147,2	7,1	141,0
WRM 177 216	45,0	55,6	5,3	49,0	WRM 551 598	140,0	152,2	7,1	146,0
WRM 196 228	50,0	58,6	5,3	53,0	WRM 551 610	140,0	155,2	10,1	147,0
WRM 196 236	50,0	60,6	5,3	54,0	WRM 570 618	145,0	157,2	7,1	151,0
WRM 216 248	55,0	63,6	5,3	58,0	WRM 590 637	150,0	162,2	7,1	156,0
WRM 220 251	56,0	64,6	5,3	59,0	WRM 629 661	160,0	168,6	5,3	163,0
WRM 220 259	56,0	66,6	5,3	60,0	WRM 629 688	160,0	175,2	10,1	168,0
WRM 236 267	60,0	68,6	5,3	63,0	WRM 673 720	171,0	183,0	6,3	176,0
WRM 255 287	65,0	73,6	5,3	68,0	WRM 688 744	175,0	189,2	7,1	182,0
WRM 255 295	65,0	75,6	5,3	69,0	WRM 708 767	180,0	195,0	10,1	188,0
WRM 275 307	70,0	78,6	5,3	73,0	WRM 708 787	180,0	200,0	10,1	190,0
WRM 275 314	70,0	80,6	5,3	74,0	WRM 787 847	200,0	215,0	10,1	207,0
WRM 275 322	70,0	82,2	7,1	76,0	WRM 787 866	200,0	220,0	10,1	210,0
WRM 283 317	72,0	80,6	5,3	75,0	WRM 102 411 02	260,0	280,0	10,2	270,0

**Web:** <http://cat.hansa-flex.com/en/WRM>

WRM FPM

Wiper WRM-FPM

Easy assembly. Simple solution. Low spatial requirement.

- Design:** Wipers
- Sliding speed max.:** 0,5 m/s
- Temp. min.:** -30 °C
- Temp. max.:** 200 °C
- Media:** Mineral oils, Water emulsions
- Installation:** bend the wiper into a kidney shape and press into the locating groove
- Material:** FPM
- Application:** Hydraulics

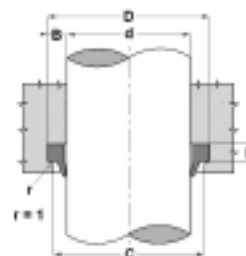

Toleranz / Tolerance			
d	D	L	C
h11	+0,20 0	+0,10 0	+0,20 0

**Ordering information:** Alternative material possible: FPM.

Identification	d	D	L	C	Identification	d	D	L	C
	mm	mm	mm	mm		mm	mm	mm	mm
WRM 078 110 FPM	20	28,6	5,3	23	WRM 220 259 FPM	56	66,6	5,3	60
WRM 086 118 FPM	22	30,6	5,3	25	WRM 236 267 FPM	60	68,6	5,3	63
WRM 098 129 FPM	25	33,6	5,3	28	WRM 275 307 FPM	70	78,6	5,3	73
WRM 110 141 FPM	28	36,6	5,3	31	WRM 275 314 FPM	70	80,6	5,3	74
WRM 118 149 FPM	30	38,6	5,3	33	WRM 433 480 FPM	110	122,2	7,1	116
WRM 137 169 FPM	35	43,6	5,3	38	WRM 708 787 FPM	180	200,0	10,2	190
WRM 157 188 FPM	40	48,6	5,3	43					

**Web:** <http://cat.hansa-flex.com/en/WRMFPM>

**WRM-H**

**Wiper WRM-H**



Toleranz / Tolerance			
d	D	L	C
h11	+0,20 0	+0,10 0	+0,20 0

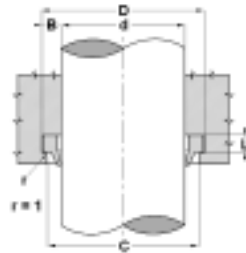

Simple solution. Easy assembly. High abrasion resistance.

- Design:** Wipers
- Sliding speed max.:** 0,8 m/s
- Temp. min.:** -30 °C
- Temp. max.:** 110 °C
- Media:** Mineral oils, Water emulsions
- Installation:** bend the wiper into a kidney shape and press into the locating groove
- Material:** Polyester
- Application:** Hydraulics

Identification	d	D	L	C	Identification	d	D	L	C
	mm	mm	mm	mm		mm	mm	mm	mm
WRM-H 20	20	28	5,0	25,5	WRM-H 50	50	58	5,0	55,5
WRM-H 25	25	33	5,0	30,5	WRM-H 60	60	70	6,3	67,0
WRM-H 28	28	36	5,0	33,5	WRM-H 70	70	80	6,3	77,0
WRM-H 30	30	38	5,0	35,5	WRM-H 80	80	90	6,3	87,0
WRM-H 32	32	40	5,0	37,5	WRM-H 90	90	100	6,3	97,0
WRM-H 36	36	44	5,0	41,5	WRM-H 100	100	115	9,5	110,0
WRM-H 40	40	48	5,0	45,5	WRM-H 110	110	125	9,5	120,0
WRM-H 45	45	53	5,0	50,5	WRM-H 125	125	140	9,5	135,0

**Web:** <http://cat.hansa-flex.com/en/WRMH>

**WRM-P**

**Wiper WRM-P**



Toleranz / Tolerance			
d	D	L	C
h11	+0,20 0	+0,10 0	+0,20 0

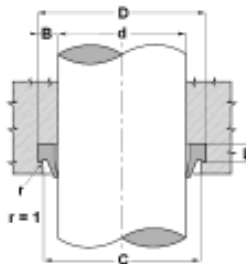

Easy assembly. Simple solution. High abrasion resistance.

- Design:** Wipers
- Sliding speed max.:** 0,8 m/s
- Temp. min.:** -30 °C
- Temp. max.:** 80 °C
- Media:** Mineral oils
- Installation:** bend the wiper into a kidney shape and press into the locating groove
- Design:** Metric
- Material:** PUR
- Application:** Hydraulics

**Ordering information:** We are able to produce wipers with diameters of 20 to 510 mm with short lead times.

Identification	d	D	L	C	Identification	d	D	L	C
	mm	mm	mm	mm		mm	mm	mm	mm
WRM-P 04	4	12,0	3,0	9,0	WRM-P 60	60	68,6	5,3	63,0
WRM-P 05-S	5	12,0	2,8	9,0	WRM-P 60-S	60	70,6	5,5	66,5
WRM-P 06-S	6	12,0	3,0	9,0	WRM-P 63	63	71,6	5,3	66,0
WRM-P 08	8	14,6	3,8	11,0	WRM-P 63-1	63	73,6	5,3	67,0
WRM-P 10	10	16,6	3,8	13,0	WRM-P 65	65	73,6	5,3	68,0
WRM-P 12	12	18,6	3,8	15,0	WRM-P 65-2	65	75,6	5,3	69,0
WRM-P 14	14	20,6	3,8	17,0	WRM-P 65-1	65	76,6	6,0	71,5
WRM-P 15	15	21,6	3,8	18,0	WRM-P 70	70	78,6	5,3	73,0
WRM-P 16-1	16	22,5	3,0	19,0	WRM-P 70-2	70	80,0	5,0	74,0
WRM-P 16	16	22,6	3,8	19,0	WRM-P 70-1	70	82,6	7,1	76,0
WRM-P 18	18	24,6	3,8	21,0	WRM-P 73-1	73	83,6	7,3	76,0
WRM-P 20-1	20	26,0	3,4	23,0	WRM-P 75	75	83,6	5,3	78,0
WRM-P 20	20	28,6	5,3	23,0	WRM-P 75-1	75	87,2	7,1	81,0
WRM-P 22	22	30,6	5,3	25,0	WRM-P 78-2	78	86,0	5,0	81,0
WRM-P 25	25	25,0	5,3	28,0	WRM-P 78-S	78	88,6	5,5	84,5
WRM-P 28	28	36,6	5,3	31,0	WRM-P 80	80	88,6	5,3	83,0
WRM-P 30	30	38,6	5,3	33,0	WRM-P 80-1	80	92,6	7,1	86,0
WRM-P 30-1	30	40,0	3,0	34,5	WRM-P 85-1	85	93,6	5,3	88,0
WRM-P 32-1	32	40,0	3,7	35,0	WRM-P 85	85	97,2	7,1	91,0
WRM-P 32	32	40,6	5,3	35,0	WRM-P 90	90	102,2	7,1	96,0
WRM-P 35	35	43,6	5,3	38,0	WRM-P 92-S	92	103,6	5,5	97,0
WRM-P 35-1B	35	45,0	4,0	39,0	WRM-P 95	95	107,2	7,1	101,0
WRM-P 36	36	44,6	5,3	39,0	WRM-P 97-2	97	105,0	5,0	100,0
WRM-P 38	38	46,6	5,3	41,0	WRM-P 99	99	109,6	5,5	103,0
WRM-P 38-1	38	48,5	4,8	41,0	WRM-P 100	100	112,2	7,1	106,0
WRM-P 40	40	48,6	5,3	43,0	WRM-P 105	105	117,2	7,1	111,0
WRM-P 42	42	50,6	5,3	45,0	WRM-P 110	110	122,2	7,1	116,0
WRM-P 45	45	53,6	5,3	48,0	WRM-P 115-1	115	123,6	5,3	118,0
WRM-P 45-1	45	55,6	5,3	48,0	WRM-P 115	115	127,2	7,1	121,0
WRM-P 45-1B	45	60,0	4,2	53,0	WRM-P 120-S	120	130,6	5,5	126,5
WRM-P 50	50	58,6	5,3	53,0	WRM-P 120	120	132,2	7,1	126,0
WRM-P 50-1	50	60,6	5,3	53,0	WRM-P 125	125	137,2	7,1	131,0
WRM-P 50-1B	50	65,5	4,2	58,0	WRM-P125-1	125	140,2	10,1	132,0
WRM-P 55	55	63,6	5,3	58,0	WRM-P 130-1	130	138,6	5,3	133,0
WRM-P 55-1	55	65,6	5,3	58,0	WRM-P 130	130	142,2	7,1	136,0
WRM-P 56	56	64,6	5,3	59,0	WRM-P 135	135	147,2	7,1	141,0
WRM-P 56-1	56	66,6	5,3	59,0	WRM-P 140-2	140	148,6	6,0	143,0

(Continued)

WRM-P

## Wiper WRM-P

Identification	d mm	D mm	L mm	C mm	Identification	d mm	D mm	L mm	C mm
WRM-P 140	140	152,2	7,1	146,0	WRM-P 180-2	180	200,0	7,0	188,0
WRM-P 140-1	140	155,0	9,0	147,0	WRM-P 180-3	180	200,0	10,2	190,0
WRM-P 141-S	141	151,6	5,5	147,5	WRM-P 183-S	183	193,6	5,5	189,0
WRM-P 145	145	157,2	7,1	151,0	WRM-P 190-2	190	198,6	5,3	193,0
WRM-P 150-2	150	158,6	5,3	153,0	WRM-P 190	190	205,2	10,1	198,0
WRM-P 150	150	162,2	7,1	156,0	WRM-P 190-1	190	210,0	10,1	200,0
WRM-P 150-1	150	165,0	7,5	156,0	WRM-P 200	200	215,2	10,1	208,0
WRM-P 150-3	150	165,2	10,1	158,0	WRM-P 200-3	200	220,0	10,2	210,0
WRM-P 160-1	160	172,2	7,1	166,0	WRM-P 220	220	235,2	10,1	228,0
WRM-P 160	160	175,2	10,1	167,6	WRM-P 220-1	220	240,0	10,1	230,0
WRM-P 162-S	162	172,6	5,5	168,0	WRM-P 230	230	245,2	10,1	238,0
WRM-P 170	170	185,2	10,1	178,0	WRM-P 240	240	255,2	10,1	248,0
WRM-P 180	180	195,2	10,1	188,0	WRM-P 300-5	300	315,2	10,1	308,0

Web: <http://cat.hansa-flex.com/en/WRMP>

WRM-PI

## Wiper WRM-PI

Easy assembly. Simple solution. High abrasion resistance.

- Design:** Wipers  
**Sliding speed max.:** 0,8 m/s  
**Temp. min.:** -30 °C  
**Temp. max.:** 80 °C  
**Media:** Mineral oils  
**Installation:** bend the wiper into a kidney shape and press into the locating groove  
**Design:** Inches  
**Material:** PUR  
**Application:** Hydraulics

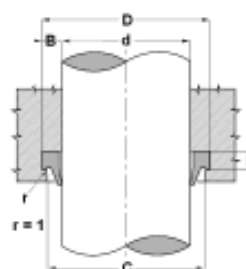

Toleranz / Tolerance			
d	D	L	C
h11	+0,20	+0,10	+0,20
	0	0	0

**Ordering information:** We are able to produce wipers with diameters of 20 to 510 mm with short lead times.

Identification	d mm	D mm	L mm	C mm	Identification	d mm	D mm	L mm	C mm
WRM-PI 050 075	12,70	19,06	3,2	16,76	WRM-PI 175 212	44,45	53,97	4,8	50,67
WRM-PI 075 112	28,57	28,57	4,8	24,88	WRM-PI 200 250	50,80	63,50	6,4	59,18
WRM-PI 087 125	22,22	31,75	4,8	28,45	WRM-PI 225 275	57,15	69,85	6,4	65,46
WRM-PI 100 137	25,40	34,92	4,8	31,62	WRM-PI 250 300	63,50	76,20	6,4	71,81
WRM-PI 112 150	28,57	38,10	4,8	34,80	WRM-PI 262 312	66,67	79,37	6,4	74,98
WRM-PI 125 162	31,75	41,27	4,8	37,97	WRM-PI 300 350	76,20	88,90	6,4	84,51
WRM-PI 137 175	34,92	44,45	4,8	41,14	WRM-PI 350 400	88,90	101,60	6,4	97,20
WRM-PI 150 187	38,10	47,62	4,8	44,32	WRM-PI 450 500	114,30	127,00	6,4	122,61
WRM-PI 162 200	41,27	50,80	4,8	47,50					

Web: <http://cat.hansa-flex.com/en/WRMPI>

## WRS

## Wiper WRS

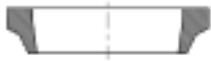

Toleranz / Tolerance			
d	D	L	C
h11	+0,20 0	+0,10 0	+0,20 0

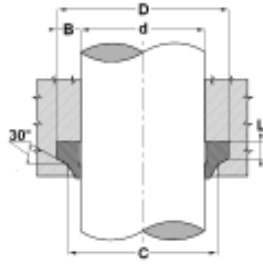

Simple solution. Easy assembly.

**Design:** Wipers

**Sliding speed max.:** 0,5 m/s

**Temp. min.:** -40 °C

**Temp. max.:** 130 °C

**Media:** Mineral oils, Water emulsions

**Installation:** bend the wiper into a kidney shape and press into the locating groove

**Material:** NBR 90° Shore A

**Application:** Hydraulics

**Ordering information:** For special operating conditions (fluid, temperature, pressure ...) please contact us. Alternative material possible: FPM.

Identification	d mm	D mm	L mm	C mm
WRS 751 25	19,05	31,75	5,3	25,45
WRS 100 150	25,40	38,10	5,3	31,80
WRS 129 179	33,00	45,70	5,3	39,40
WRS 157 207	40,00	52,70	5,3	46,40
WRS 187 237	47,62	60,32	5,3	54,02
WRS 196 246	50,00	62,70	5,3	56,40
WRS 200 250	50,80	63,50	5,3	57,20
WRS 220 270	56,00	68,70	5,3	62,40
WRS 225 275	57,15	69,85	5,3	63,55
WRS 236 286	60,00	72,70	5,3	66,40

Identification	d mm	D mm	L mm	C mm
WRS 248 298	63,00	75,70	5,3	69,40
WRS 275 325	70,00	82,70	5,3	76,40
WRS 300 350	76,20	88,90	5,3	82,40
WRS 315 365	80,00	92,70	5,3	86,40
WRS 325 375	82,55	95,25	5,3	88,95
WRS 346 396	88,00	100,70	5,3	94,40
WRS 354 404	90,00	102,70	5,3	96,40
WRS 374 424	95,00	107,70	5,3	101,40
WRS 600 650	152,40	165,10	5,3	158,40

**Web:** <http://cat.hansa-flex.com/en/WRS>

## WTF A

## Wiper WTF-A

Low dynamic friction. No stick-slip. Long service life. Low spatial requirement. Extreme temperatures -45°C to 200°C with Viton O-ring Extremely good wiper effect from inside against the residual oil film on the surface of the rod.

<b>Design:</b>	Wipers
<b>Sliding speed max.:</b>	15,0 m/s
<b>Temp. min.:</b>	-30 °C
<b>Temp. max.:</b>	110 °C
<b>Media:</b>	Mineral oils
<b>Installation:</b>	first bend the O-ring and then the PTFE ring into a kidney shape, and press into the locating groove (from 30 mm).
<b>Material:</b>	(1) Dynamic seal: PTBR, (2) Static seal: NBR
<b>Application:</b>	Hydraulics

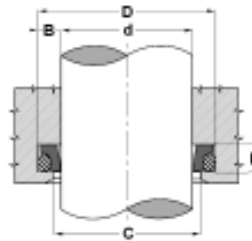

Toleranz / Tolerance			
d	D	C	L
h8	H9	H11	0 +0,20

Identification	d mm	D mm	H mm	C mm
K-DWTF 0100 A124470	10	14,8	3,7	12,7
K-DWTF 0120 A124470	12	18,8	5,0	15,5
K-DWTF 0160 A124470	16	22,8	5,0	19,5
K-DWTF 0180 A124470	18	24,8	5,0	21,5
K-DWTF 0200 A124470	20	26,8	5,0	23,5
K-DWTF 0280 A124470	28	34,8	5,0	31,5
K-DWTF 0400 A124470	40	46,8	5,0	43,5
K-DWTF 0450 A124470	45	51,8	5,0	48,5
K-DWTF 0500 A124470	50	56,8	5,0	53,5
K-DWTF 0650 A124470	65	73,8	6,0	69,0
K-DWTF 1000 A124470	100	108,8	6,0	104,0
K-DWTF 1100 A124470	110	118,8	6,0	114,0
K-DWTF 1400 A124470	140	148,8	6,0	144,0

**Web:** <http://cat.hansa-flex.com/en/WTF A>

## WTF B

## Wiper WTF-B

Low dynamic friction. No stick-slip. Low spatial requirement. Long service life. Extreme temperatures -45°C to 200°C with Viton O-ring Extremely good wiper effect from inside against the residual oil film on the surface of the rod.

<b>Design:</b>	Wipers
<b>Sliding speed max.:</b>	15,0 m/s
<b>Temp. min.:</b>	-30 °C
<b>Temp. max.:</b>	110 °C
<b>Media:</b>	Mineral oils
<b>Installation:</b>	first bend the O-ring and then the PTFE ring into a kidney shape, and press into the locating groove (from 30 mm).
<b>Material:</b>	(1) Dynamic seal: PTBR, (2) Static seal: NBR
<b>Application:</b>	Hydraulics

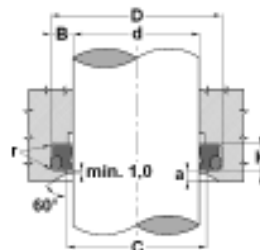

Toleranz / Tolerance			
d	D	C	L
f8 / h9	H9	H11	0 +0,20

Identification	d mm	D mm	H mm	C mm	Identification	d mm	D mm	H mm	C mm
WTF 0080 B554470	8	12,8	3,7	10,7	WTF 0600 B554470	60	66,8	5,0	63,5
WTF 0100 B554470	10	14,8	3,7	12,7	WTF 0650 B554470	65	73,8	6,0	69,0
WTF 0120 B554470	12	18,8	5,0	15,5	WTF 0700 B554470	70	78,8	6,0	74,0
WTF 0140 B554470	14	20,8	5,0	17,5	WTF 0750 B554470	75	83,8	6,0	79,0
WTF 0150 B554470	15	21,8	5,0	18,5	WTF 0800 B554470	80	88,8	6,0	84,0
WTF 0160 B554470	16	22,8	5,0	19,5	WTF 0850 B554470	85	93,8	6,0	89,0
WTF 0180 B554470	18	24,8	5,0	21,5	WTF 0900 B554470	90	98,8	6,0	94,0
WTF 0200 B554470	20	26,8	5,0	23,5	WTF 0950 B554470	95	103,8	6,0	99,0
WTF 0220 B554470	22	28,8	5,0	23,5	WTF 1000 B554470	100	108,8	6,0	104,0
WTF 0250 B554470	25	31,8	5,0	28,5	WTF 1050 B554470	105	113,8	6,0	109,0
WTF 0280 B554470	28	34,8	5,0	31,5	WTF 1100 B554470	110	118,8	6,0	114,0
WTF 0300 B554470	30	36,8	5,0	33,5	WTF 1200 B554470	120	128,8	6,0	124,0
WTF 0320 B554470	32	38,8	5,0	35,5	WTF 1500 B554470	150	158,8	6,0	154,0
WTF 0350 B554470	35	41,8	5,0	38,5	WTF 1530 B554470	153	161,8	6,0	157,0
WTF 0400 B554470	40	46,8	5,0	43,5	WTF 1700 B554470	170	178,8	6,0	174,0
WTF 0420 B554470	42	48,8	5,0	45,5	WTF 1730 B554470	173	181,8	6,0	177,0
WTF 0450 B554470	45	51,8	5,0	48,5	WTF 2100 B554470	210	218,8	6,0	214,0
WTF 0500 B554470	50	56,8	5,0	53,5	WTF 2400 B554470	240	248,8	6,0	244,0
WTF 0550 B554470	55	61,8	5,0	58,5					

**Web:** <http://cat.hansa-flex.com/en/WTF B>

## WTFP B

## Wiper WTFP-B



Toleranz / Tolerance			
d	D	C	L
f8 / h9	H9	H11	0 +0,20

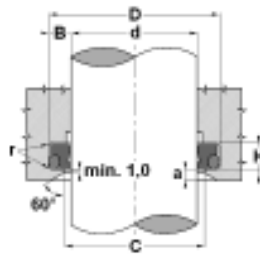

Low dynamic friction. No stick-slip. Low spatial requirement. Long service life. Extreme temperatures -45°C to 200°C with Viton O-ring. Extremely good wiper effect from inside against the residual oil film on the surface of the rod.

**Design:** Wipers  
**Sliding speed max.:** 15,0 m/s  
**Temp. min.:** -30 °C  
**Temp. max.:** 110 °C  
**Media:** Mineral oils  
**Installation:** first bend the O-ring and then the PTFE ring into a kidney shape, and press into the locating groove (from 30 mm).  
**Material:** (1) Dynamic seal: PTBR, (2) Static seal: NBR  
**Application:** Hydraulics

Identification	d	D	H	C
	mm	mm	mm	mm
WTFP 0200 B554470	20	27,6	4,2	21,5
WTFP 0220 B554470	22	29,6	4,2	23,5
WTFP 0250 B554470	25	32,6	4,2	26,5
WTFP 0280 B554470	28	35,6	4,2	29,5
WTFP 0300 B554470	30	37,6	4,2	31,5
WTFP 0320 B554470	32	39,6	4,2	33,5
WTFP 0350 B554470	35	42,6	4,2	36,5
WTFP 0360 B554470	36	43,6	4,2	37,5
WTFP 0400 B554470	40	48,8	6,3	41,5
WTFP 0420 B554470	42	50,8	6,3	43,5
WTFP 0450 B554470	45	53,8	6,3	46,5
WTFP 0500 B554470	50	58,8	6,3	51,5
WTFP 0550 B554470	55	63,8	6,3	56,5
WTFP 0560 B554470	56	64,8	6,3	57,5
WTFP 0600 B554470	60	68,8	6,3	61,5
WTFP 0630 B554470	63	71,8	6,3	64,5
WTFP 0650 B554470	65	73,8	6,3	66,5
WTFP 0700 B554470	70	82,2	8,1	72,0
WTFP 0750 B554470	75	87,2	8,1	77,0
WTFP 0800 B554470	80	92,2	8,1	82,0
WTFP 0850 B554470	85	97,2	8,1	87,0
WTFP 0900 B554470	90	102,2	8,1	92,0
WTFP 0950 B554470	95	107,2	8,1	97,0

Identification	d	D	H	C
	mm	mm	mm	mm
WTFP 1000 B554470	100	112,2	8,1	102,0
WTFP 1100 B554470	110	122,2	8,1	112,0
WTFP 1200 B554470	120	132,2	8,1	122,0
WTFP 1250 B554470	125	137,2	8,1	127,0
WTFP 1300 B554470	130	142,2	8,1	132,0
WTFP 1350 B554470	135	147,2	8,1	137,0
WTFP 1400 B554470	140	156,0	9,5	142,5
WTFP 1500 B554470	150	166,0	9,5	152,5
WTFP 1600 B554470	160	176,0	9,5	162,5
WTFP 1700 B554470	170	186,0	9,5	172,5
WTFP 1800 B554470	180	196,0	9,5	182,5
WTFP 1900 B554470	190	206,0	9,5	192,5
WTFP 2000 B554470	200	216,0	9,5	202,5
WTFP 2100 B554470	210	226,0	9,5	212,5
WTFP 2200 B554470	220	236,0	9,5	222,5
WTFP 2300 B554470	230	246,0	9,5	232,5
WTFP 2400 B554470	240	256,0	9,5	242,5
WTFP 2500 B554470	250	266,0	9,5	252,5
WTFP 2600 B554470	260	276,0	9,5	262,5
WTFP 2700 B554470	270	286,0	9,5	272,5
WTFP 2800 B554470	280	296,0	9,5	282,5
WTFP 3000 B554470	300	316,0	9,5	302,5

**Web:** <http://cat.hansa-flex.com/en/WTFPB>

## WTFP BPU

## Wiper WTFP-BPU



Toleranz / Tolerance			
d	D	C	L
f8 / h9	H9	H11	0 +0,20

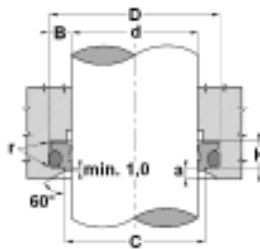

Low dynamic friction. High abrasion resistance. Low spatial requirement. Long service life. Extremely good wiper effect from inside against the residual oil film on the surface of the rod.

**Design:** Wipers  
**Sliding speed max.:** 2,0 m/s  
**Temp. min.:** -30 °C  
**Temp. max.:** 110 °C  
**Media:** Mineral oils  
**Installation:** first bend the O-ring and then the PTFE ring into a kidney shape, and press into the locating groove (from 30 mm).  
**Material:** (1) Dynamic seal: H-PU D55, (2) Static seal: NBR  
**Application:** Hydraulics

Identification	d	D	H	C
	mm	mm	mm	mm
WTFP 0250 BPU40447	25	32,6	4,2	26,5
WTFP 0350 BPU40447	35	42,6	4,2	36,5
WTFP 0500 BPU40447	50	58,8	6,3	51,5
WTFP 0550 BPU40447	55	63,8	6,3	56,5
WTFP 0560 BPU40447	56	64,8	6,3	57,5
WTFP 0600 BPU40447	60	68,8	6,3	61,5
WTFP 0700 BPU40447	70	82,2	8,1	72,0

Identification	d	D	H	C
	mm	mm	mm	mm
WTFP 0750 BPU40447	75	87,2	8,1	77,0
WTFP 0800 BPU40447	80	92,2	8,1	82,0
WTFP 0900 BPU40447	90	102,2	8,1	92,0
WTFP 0950 BPU40447	95	107,2	8,1	97,0
WTFP 1000 BPU40447	100	112,2	8,1	102,0
WTFP 1100 BPU40447	110	122,2	8,1	112,0
WTFP 1400 BPU40447	140	156,0	9,5	142,5

**Web:** <http://cat.hansa-flex.com/en/WTFPBPU>

## E-DWR

## Piston guide E-DWR

Easy working of the fitting groove and assembly. High load-bearing capacity.  
Low coefficient of wear and low coefficient of friction (between 0.05 and 0.1)  
available in many sizes.

**Design:** Guide ring  
**Sliding speed max.:** 0,8 m/s  
**Surface pressure:** at 20°C 15 N/mm<sup>2</sup>; at 100°C 10 N/mm<sup>3</sup>  
**Temp. min.:** -30 °C  
**Temp. max.:** 110 °C  
**Media:** Mineral oils, Water emulsions  
**Installation:** insert into the groove  
**Material:** acetal resin + glass fibre  
**Application:** Hydraulics

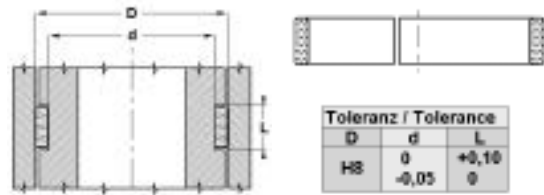

**Note:** Calculation of shear force;  $F = p \times D \times L \times n$   $F =$  maximum shear force (N)  $p =$  maximum surface pressure (N/mm<sup>2</sup>)  $D \times L =$  projected area (mm<sup>2</sup>)  $n =$  quantity of rings

**Ordering information:** We are able to produce guide rings with diameters of 20 to 510 mm with short lead times.

Identification	D	d	L	Identification	D	d	L
	mm	mm	mm		mm	mm	mm
E-DWR 20-2-9.6	20	16	9,6	E-DWR 70-3-12.8	70	64	12,8
E-DWR 22-2-9.6	22	18	9,6	E-DWR 74-3-12.8	74	68	12,8
E-DWR 25-2-9.6	25	21	9,6	E-DWR 75-3-12.8	75	69	12,8
E-DWR 28-2-9.6	28	24	9,6	E-DWR 80-3-12.8	80	74	12,8
E-DWR 30-2-9.6	30	26	9,6	E-DWR 85-3-12.8	85	79	12,8
E-DWR 32-2-9.6	32	28	9,6	E-DWR 90-3-10	90	84	10,0
E-DWR 34-2-9.6	34	30	9,6	E-DWR 100-3-12.8	100	94	12,8
E-DWR 34-2-16	34	30	16,0	E-DWR 105-3-12.8	105	99	12,8
E-DWR 35-2-9.6	35	31	9,6	E-DWR 110-3-12.8	110	104	12,8
E-DWR 36-2-9.6	36	32	9,6	E-DWR 115-3-12.8	115	109	12,8
E-DWR 40-3-9.6	40	34	9,6	E-DWR 120-3-12.8	120	114	12,8
E-DWR 40-2-9.6	40	36	9,6	E-DWR 125-3-12.8	125	119	12,8
E-DWR 45-3-9.6	45	39	9,6	E-DWR 135-3-12.8	135	129	12,8
E-DWR 45-2-9.6	45	41	9,6	E-DWR 135-3-19.2	135	129	19,2
E-DWR 50-3-9.6	50	44	9,6	E-DWR 140-3-12.8	140	134	12,8
E-DWR 50-3-12.8	50	44	12,8	E-DWR 150-3-12.8	150	144	12,8
E-DWR 55-3-12.8	55	49	12,8	E-DWR 155-3-19.2	155	149	19,2
E-DWR 56-3-12.8	56	50	12,8	E-DWR 160-3-19.2	160	154	19,2
E-DWR 60-3-12.8	60	54	12,8	E-DWR 165-3-19.2	165	159	19,2
E-DWR 63-3-12.8	63	57	12,8	E-DWR 180-3-20	180	174	20,0
E-DWR 65-3-12.8	65	59	12,8	E-DWR 250-3-19.2	250	244	19,2

**Web:** <http://cat.hansa-flex.com/en/EDWR>

## I-DWR

## Rod guide I-DWR

Easy working of the fitting groove and assembly. High load-bearing capacity.  
Low coefficient of wear and low coefficient of friction (between 0.05 and 0.1)  
available in many sizes.

**Sliding speed max.:** 0,8 m/s  
**Surface pressure:** at 20°C 15 N/mm<sup>2</sup>; at 100°C 10 N/mm<sup>3</sup>  
**Temp. min.:** -30 °C  
**Temp. max.:** 110 °C  
**Media:** Mineral oils, Water emulsions  
**Installation:** insert into the groove  
**Material:** acetal resin + glass fibre



**Note:** Calculation of shear force;  $F = p \times D \times L \times n$   $F =$  maximum shear force (N)  $p =$  maximum surface pressure (N/mm<sup>2</sup>)  $D \times L =$  projected area (mm<sup>2</sup>)  $n =$  quantity of rings

**Ordering information:** We are able to produce guide rings with diameters of 20 to 510 mm with short lead times.

Identification	D	d	L	Identification	D	d	L
	mm	mm	mm		mm	mm	mm
I-DWR 18-2-9.6	22	18	9,60	I-DWR 40-2-9.6	44	40	9,60
I-DWR 20-2-9.6	24	20	9,60	I-DWR 40-3-9.6	46	40	9,60
I-DWR 25-2-9.6	29	25	9,60	I-DWR 40-3-12.8	46	40	12,80
I-DWR 26-2-7.5	30	26	7,50	I-DWR 42-3-9.6	48	42	9,60
I-DWR 28-2-9.6	32	28	9,60	I-DWR 44-3-9.6	50	44	9,60
I-DWR 30-2-9.6	34	30	9,60	I-DWR 45-3-9.6	51	45	9,60
I-DWR 30-3-9.6	36	30	9,60	I-DWR 45-3-12.8	51	45	12,80
I-DWR 32-2-9.6	36	32	9,60	I-DWR 48-3-9.6	54	48	9,60
I-DWR 32-3-10	38	32	10,00	I-DWR 50-3-9.6	56	50	9,60
I-DWR 34-2-9.6	38	34	9,60	I-DWR 50-3-12.8	56	50	12,80
I-DWR 35-2-9.6	39	35	9,60	I-DWR 53-3-9.6	59	53	9,60
I-DWR 35-2-12.8	39	35	12,80	I-DWR 55-3-9.6	61	55	9,60
I-DWR 35-3-9.6	41	35	9,60	I-DWR 55-3-12.8	61	55	12,80
I-DWR 36-2-9.6	40	36	9,60	I-DWR 56-3-12.8	62	56	12,80
I-DWR 36-3-9.6	42	36	9,60	I-DWR 60-3-12	66	60	12,00
I-DWR 38-2-9.6	42	38	9,60	I-DWR 60-3-12.8	66	60	12,80
I-DWR 38-2-18	42	38	18,00	I-DWR 63-3-12.8	69	63	12,80

## I-DWR

(Continued)

## Rod guide I-DWR

Identification	D mm	d mm	L mm
I-DWR 65-3-12.8	71	65	12,80
I-DWR 70-3-12.8	76	70	12,80
I-DWR 75-3-12.8	81	75	12,80
I-DWR 75-3-19.2	81	75	19,20
I-DWR 76-3-12.8	82	76	12,80
I-DWR 78-3-25	84	78	25,00
I-DWR 80-3-12.8	96	80	12,80
I-DWR 90-3-12.8	96	90	12,80
I-DWR 100-3-12.8	106	100	12,80
I-DWR 105-3-12.8	111	105	12,80

Identification	D mm	d mm	L mm
I-DWR 105-3-19.2	111	105	19,20
I-DWR 110-3-12.8	116	110	12,80
I-DWR 110-3-25.75	116	110	25,75
I-DWR 115-3-12.8	121	115	12,80
I-DWR 125-3-12.8	131	125	12,80
I-DWR 130-3-12.8	136	130	12,80
I-DWR 145-3-12.8	151	145	12,80
I-DWR 160-3-19.2	166	160	19,20
I-DWR 200-3-19.2	206	200	19,20

**Web:** <http://cat.hansa-flex.com/en/IDWR>



## E-GTP

## Piston guide E-GTP

Easy working of the fitting groove and assembly. Low coefficient of friction.  
High load-bearing capacity.

**Sliding speed max.:** 1,0 m/s

**Pressure resistance as DIN**

**53454 (N/mm<sup>2</sup>):** 270 N/mm<sup>2</sup>

**Surface pressure:** 35 N/mm<sup>2</sup>

**Temp. min.:** -40 °C

**Temp. max.:** 120 °C

**Media:** Mineral oils

**Installation:** insert into the groove

**Material:** phenol resin-cotton fabric

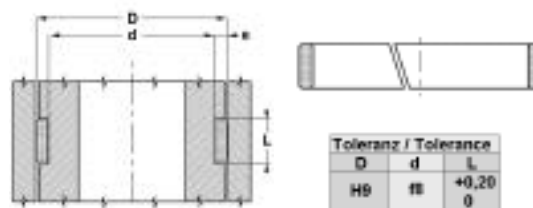

**Note:** Calculation of shear force;  $F = p \times D \times L \times n$   $F =$  maximum shear force (N)  $p =$  maximum surface pressure (N/mm<sup>2</sup>)  $D \times L =$  projected area (mm<sup>2</sup>)  $n =$  quantity of rings

Identification	D	d	L	Identification	D	d	L
	mm	mm	mm		mm	mm	mm
EGTP 250 970 600 A	60	55	9,7	EGTP 353 501 500 A	150	143	35,0
EGTP 250 970 700 A	70	65	9,7	EGTP 501 501 000 A	100	90	15,0
EGTP 251 500 550 A	55	50	15,0	EGTP 501 501 100 A	110	100	15,0
EGTP 251 500 750 A	75	70	15,0	EGTP 501 501 200 A	120	110	15,0
EGTP 251 500 850 A	85	80	15,0	EGTP 501 501 300 A	130	120	15,0
EGTP 251 500 900 A	90	85	15,0	EGTP 501 501 500 A	150	140	15,0
EGTP 251 500 950 A	95	90	15,0	EGTP 501 621 000 A	100	90	16,2
EGTP 251 501 200 A	120	115	15,0	EGTP 501 621 100 A	110	100	16,2
EGTP 302 500 900 A	90	85	15,0	EGTP 501 621 200 A	120	110	16,2
EGTP 302 501 000 A	100	94	25,0	EGTP 501 621 300 A	130	120	16,2
EGTP 303 001 200 A	120	114	30,0	EGTP 501 621 400 A	140	130	16,2
EGTP 303 001 500 A	150	144	30,0	EGTP 501 621 500 A	150	140	16,2
EGTP 353 001 300 A	130	123	30,0	EGTP 502 321 600 A	160	150	23,2
EGTP 353 501 400 A	140	133	35,0	EGTP 502 321 800 A	180	170	23,2

**Web:** <http://cat.hansa-flex.com/en/EGTP>

## I-GTP A

## Rod guide I-GTP

Easy working of the fitting groove and assembly. Low coefficient of friction.  
High load-bearing capacity.

**Design:** Guide ring

**Sliding speed max.:** 1,0 m/s

**Pressure resistance as DIN**

**53454 (N/mm<sup>2</sup>):** 270 N/mm<sup>2</sup>

**Surface pressure:** 35 N/mm<sup>2</sup>

**Temp. min.:** -40 °C

**Temp. max.:** 120 °C

**Media:** Mineral oils

**Installation:** insert into the groove

**Material:** phenol resin-cotton fabric

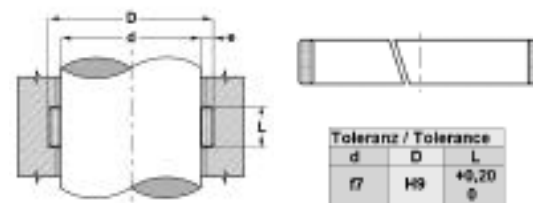

**Note:** Calculation of shear force;  $F = p \times D \times L \times n$   $F =$  maximum shear force (N)  $p =$  maximum surface pressure (N/mm<sup>2</sup>)  $D \times L =$  projected area (mm<sup>2</sup>)  $n =$  quantity of rings

Identification	D	d	L	Identification	D	d	L
	mm	mm	mm		mm	mm	mm
IGTP 250 560 280 A	33	28	5,6	IGTP 251 521 000 A	105	100	15,2
IGTP 250 970 550 A	60	55	9,7	IGTP 251 521 200 A	125	120	15,2
IGTP 251 300 600 A	65	60	13,0	IGTP 251 600 650 A	70	65	16,0
IGTP 251 500 500 A	55	50	15,0	IGTP 251 600 700 A	75	70	16,0
IGTP 251 500 700 A	75	70	15,0	IGTP 251 600 800 A	85	80	16,0
IGTP 251 500 800 A	85	80	15,0	IGTP 255 020 700 A	75	70	50,2
IGTP 251 500 850 A	90	85	15,0	IGTP 255 020 800 A	85	80	50,2
IGTP 251 500 900 A	95	90	15,0	IGTP 255 020 900 A	95	90	50,2
IGTP 251 501 150 A	120	115	15,0	IGTP 256 021 000 A	105	100	60,2
IGTP 251 520 700 A	75	70	15,2	IGTP 256 521 100 A	115	110	65,2
IGTP 251 520 800 A	85	80	15,2	IGTP 257 021 200 A	125	120	70,2
IGTP 251 520 900 A	95	90	15,2				

**Web:** <http://cat.hansa-flex.com/en/IGTPA>

**E-GTP1**

**Piston guide E-GTP1**



Toleranz / Tolerance		
D	d	L
H9	f8	+0,20 0

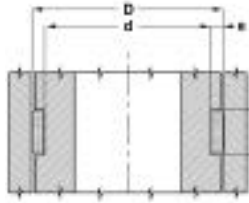

Easy working of the fitting groove and assembly. High load-bearing capacity. Low coefficient of friction (PTFE). No water absorption. Long service life.

- Design:** Guide ring
- Sliding speed max.:** 1,0 m/s
- Pressure resistance as DIN 53454 (N/mm<sup>2</sup>):** 340 N/mm<sup>2</sup>
- Surface pressure:** 50 N/mm<sup>2</sup>
- Temp. min.:** -40 °C
- Temp. max.:** 130 °C
- Media:** Mineral oils, Water emulsions
- Installation:** insert into the groove
- Material:** phenol resin-synthetic fibre fabric laminate with PTFE
- Application:** Hydraulics

**Note:** Calculation of shear force;  $F = p \times D \times L \times n$  F= maximum shear force (N) p = maximum surface pressure (N/mm<sup>2</sup>) D x L= projected area (mm<sup>2</sup>) n= quantity of rings

Identification	D mm	d mm	L mm	Standard grooves
EGTP1 250 560 250 A	25	20	5,6	ISO 10766
EGTP1 250 630 250 A	25	20	6,3	
EGTP1 250 560 300 A	30	25	5,6	
EGTP1 250 630 300 A	30	25	6,3	
EGTP1 250 970 300 A	30	25	9,7	
EGTP1 250 630 320 A	32	27	6,3	
EGTP1 250 970 320 A	32	27	9,7	
EGTP1 250 560 350 A	35	30	5,6	
EGTP1 250 970 350 A	35	30	9,7	
EGTP1 251 500 350 A	35	30	15,0	
EGTP1 250 560 400 A	40	35	5,6	ISO 10766
EGTP1 250 630 400 A	40	35	6,3	
EGTP1 250 970 400 A	40	35	9,7	
EGTP1 251 500 400 A	40	35	15,0	
EGTP1 250 560 450 A	45	40	5,6	
EGTP1 250 630 450 A	45	40	6,3	
EGTP1 250 970 450 A	45	40	9,7	
EGTP1 251 500 450 A	45	40	15,0	
EGTP1 250 560 500 A	50	45	5,6	ISO 10766
EGTP1 250 970 500 A	50	45	9,7	
EGTP1 251 500 500 A	50	45	15,0	
EGTP1 252 000 500 A	50	45	20,0	
EGTP1 252 000 500 A	50	45	25,0	
EGTP1 250 560 550 A	55	50	5,6	
EGTP1 250 970 550 A	55	50	9,7	
EGTP1 251 500 550 A	55	50	15,0	
EGTP1 252 000 550 A	55	50	20,0	
EGTP1 250 560 600 A	60	55	5,6	
EGTP1 250 970 600 A	60	55	9,7	
EGTP1 251 500 600 A	60	55	15,0	
EGTP1 252 000 600 A	60	55	20,0	
EGTP1 250 560 630 A	63	58	5,6	
EGTP1 250 970 630 A	63	58	9,7	ISO 10766
EGTP1 251 500 630 A	63	58	15,0	
EGTP1 252 000 630 A	63	58	20,0	
EGTP1 250 560 650 A	65	60	5,6	
EGTP1 250 970 650 A	65	60	9,7	
EGTP1 251 500 650 A	65	60	15,0	
EGTP1 252 000 650 A	65	60	20,0	
EGTP1 250 560 700 A	70	65	5,6	
EGTP1 250 970 700 A	70	65	9,7	
EGTP1 251 500 700 A	70	65	15,0	
EGTP1 252 000 700 A	70	65	20,0	
EGTP1 250 560 750 A	75	70	5,6	
EGTP1 250 970 750 A	75	70	9,7	
EGTP1 251 500 750 A	75	70	15,0	
EGTP1 252 000 750 A	75	70	20,0	
EGTP1 252 500 750 A	75	70	25,0	
EGTP1 250 560 800 A	80	75	5,6	ISO 10766
EGTP1 250 630 800 A	80	75	6,3	
EGTP1 250 970 800 A	80	75	9,7	ISO 10766
EGTP1 251 500 800 A	80	75	15,0	
EGTP1 252 000 800 A	80	75	20,0	
EGTP1 252 500 800 A	80	75	25,0	
EGTP1 250 560 850 A	85	80	5,6	
EGTP1 250 970 850 A	85	80	9,7	
EGTP1 251 500 850 A	85	80	15,0	
EGTP1 252 000 850 A	85	80	20,0	
EGTP1 252 500 850 A	85	80	25,0	
EGTP1 250 560 900 A	90	85	5,6	
EGTP1 250 970 900 A	90	85	9,7	
EGTP1 251 500 900 A	90	85	15,0	
EGTP1 252 000 900 A	90	85	20,0	
EGTP1 252 500 900 A	90	85	25,0	
EGTP1 250 970 950 A	95	90	9,7	
EGTP1 251 500 950 A	95	90	15,0	
EGTP1 252 000 950 A	95	90	20,0	
EGTP1 252 500 950 A	95	90	25,0	

Identification	D mm	d mm	L mm	Standard grooves
EGTP1 250 561 000 A	100	95	5,6	ISO 10766
EGTP1 250 971 000 A	100	95	9,7	ISO 10766
EGTP1 251 501 000 A	100	95	15,0	
EGTP1 252 001 000 A	100	95	20,0	
EGTP1 252 501 000 A	100	95	25,0	
EGTP1 250 971 050 A	105	100	9,7	
EGTP1 251 501 050 A	105	100	15,0	
EGTP1 252 001 050 A	105	100	20,0	
EGTP1 252 501 050 A	105	100	25,0	
EGTP1 250 971 100 A	110	105	9,7	
EGTP1 251 501 100 A	110	105	15,0	
EGTP1 252 001 100 A	110	105	20,0	
EGTP1 252 501 100 A	110	105	25,0	
EGTP1 250 971 150 A	115	110	9,7	
EGTP1 251 501 150 A	115	110	15,0	
EGTP1 252 001 150 A	115	110	20,0	
EGTP1 252 501 150 A	115	110	25,0	
EGTP1 250 971 200 A	120	115	9,7	
EGTP1 251 501 200 A	120	115	15,0	
EGTP1 252 001 200 A	120	115	20,0	
EGTP1 252 501 200 A	120	115	25,0	
EGTP1 250 971 250 A	125	120	9,7	ISO 10766
EGTP1 251 501 250 A	125	120	15,0	
EGTP1 252 001 250 A	125	120	20,0	
EGTP1 252 501 250 A	125	120	25,0	
EGTP1 250 971 300 A	130	125	9,7	
EGTP1 251 501 300 A	130	125	15,0	
EGTP1 252 001 300 A	130	125	20,0	
EGTP1 252 501 300 A	130	125	25,0	
EGTP1 250 971 350 A	135	130	9,7	
EGTP1 251 501 350 A	135	130	15,0	
EGTP1 250 971 400 A	140	135	9,7	ISO 10766
EGTP1 251 501 400 A	140	135	15,0	ISO 10766
EGTP1 252 001 400 A	140	135	20,0	
EGTP1 252 501 400 A	140	135	25,0	
EGTP1 251 501 450 A	145	140	15,0	
EGTP1 252 001 450 A	145	140	20,0	
EGTP1 252 501 450 A	145	140	25,0	
EGTP1 250 971 500 A	150	145	9,7	
EGTP1 251 501 500 A	150	145	15,0	
EGTP1 252 001 500 A	150	145	20,0	
EGTP1 252 501 500 A	150	145	25,0	
EGTP1 250 971 600 A	160	155	9,7	ISO 10766
EGTP1 251 501 600 A	160	155	15,0	ISO 10766
EGTP1 252 001 600 A	160	155	20,0	
EGTP1 252 501 600 A	160	155	25,0	
EGTP1 252 501 650 A	165	160	25,0	
EGTP1 250 971 700 A	170	165	9,7	
EGTP1 251 501 700 A	170	165	15,0	
EGTP1 252 001 700 A	170	165	20,0	
EGTP1 250 971 800 A	180	175	9,7	ISO 10766
EGTP1 251 501 800 A	180	175	15,0	ISO 10766
EGTP1 252 501 800 A	180	175	25,0	
EGTP1 251 501 850 A	185	180	15,0	
EGTP1 250 971 900 A	190	185	9,7	
EGTP1 250 972 000 A	200	195	9,7	ISO 10766
EGTP1 251 502 000 A	200	195	15,0	
EGTP1 252 002 000 A	200	195	20,0	
EGTP1 252 502 000 A	200	195	25,0	
EGTP1 252 502 050 A	205	200	25,0	
EGTP1 251 502 200 A	220	215	15,0	ISO 10766
EGTP1 252 502 250 A	225	220	25,0	
EGTP1 252 502 300 A	230	225	25,0	
EGTP1 252 502 400 A	240	235	25,0	
EGTP1 251 502 450 A	245	240	15,0	
EGTP1 251 502 500 A	250	245	15,0	ISO 10766
EGTP1 252 502 500 A	250	245	25,0	
EGTP1 252 503 000 A	300	294	25,0	
EGTP1 252 503 600 A	360	355	25,0	



(Continued)

E-GTP1

Piston guide E-GTP1

Web: <http://cat.hansa-flex.com/en/EGTP1>

I-GTP1 A

Rod guide I-GTP1

Easy working of the fitting groove and assembly. High load-bearing capacity.  
Low coefficient of friction (PTFE). No water absorption. Long service life.

**Design:** Guide ring  
**Sliding speed max.:** 1,0 m/s  
**Pressure resistance as DIN 53454 (N/mm<sup>2</sup>):** 340 N/mm<sup>2</sup>  
**Surface pressure:** 50 N/mm<sup>2</sup>  
**Temp. min.:** -40 °C  
**Temp. max.:** 130 °C  
**Media:** Mineral oils, Water emulsions  
**Installation:** insert into the groove

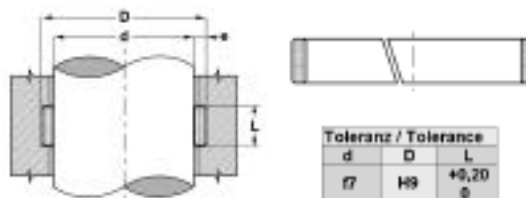

**Note:** Calculation of shear force;  $F = p \times D \times L \times n$   $F =$  maximum shear force (N)  $p =$  maximum surface pressure (N/mm<sup>2</sup>)  $D \times L =$  projected area (mm<sup>2</sup>)  $n =$  quantity of rings

Identification	D mm	d mm	L mm	Standard grooves
IGTP1 200 630 200 A	24	20	6,3	
IGTP1 250 630 220 A	27	22	6,3	
IGTP1 250 560 250 A	30	25	5,6	ISO 10766
IGTP1 250 630 250 A	30	25	6,3	
IGTP1 250 970 250 A	30	25	9,7	
IGTP1 250 560 280 A	33	28	5,6	ISO 10766
IGTP1 250 630 280 A	33	28	6,3	
IGTP1 250 560 300 A	35	30	5,6	
IGTP1 250 970 300 A	35	30	9,7	
IGTP1 250 560 320 A	37	32	5,6	ISO 10766
IGTP1 250 630 320 A	37	32	6,3	
IGTP1 250 970 320 A	37	32	9,7	ISO 10766
IGTP1 250 560 350 A	40	35	5,6	
IGTP1 251 500 350 A	40	35	15,0	
IGTP1 250 560 360 A	41	36	5,6	ISO 10766
IGTP1 250 630 360 A	41	36	6,3	
IGTP1 250 970 360 A	41	36	9,7	ISO 10766
IGTP1 251 500 360 A	41	36	15,0	
IGTP1 250 560 400 A	45	40	5,6	ISO 10766
IGTP1 250 970 400 A	45	40	9,7	ISO 10766
IGTP1 250 560 450 A	50	45	5,6	ISO 10766
IGTP1 250 970 450 A	50	45	9,7	ISO 10766
IGTP1 252 000 450 A	50	45	20,0	
IGTP1 252 500 450 A	50	45	25,0	
IGTP1 250 560 500 A	55	50	5,6	ISO 10766
IGTP1 250 970 500 A	55	50	9,7	ISO 10766
IGTP1 251 500 500 A	55	50	15,0	
IGTP1 252 000 500 A	55	50	20,0	
IGTP1 250 560 550 A	60	55	5,6	ISO 10766
IGTP1 250 970 550 A	60	55	9,7	
IGTP1 251 500 550 A	60	55	15,0	
IGTP1 250 560 560 A	61	56	5,6	ISO 10766
IGTP1 250 970 560 A	61	56	9,7	ISO 10766
IGTP1 251 500 560 A	61	56	15,0	
IGTP1 250 560 600 A	65	60	5,6	
IGTP1 250 970 600 A	65	60	9,7	
IGTP1 251 500 600 A	65	60	15,0	
IGTP1 250 970 630 A	68	63	9,7	ISO 10766
IGTP1 250 560 650 A	70	65	5,6	
IGTP1 250 970 650 A	70	65	9,7	
IGTP1 251 500 650 A	70	65	15,0	
IGTP1 252 000 650 A	70	65	20,0	

Identification	D mm	d mm	L mm	Standard grooves
IGTP1 252 500 650 A	70	65	25,0	
IGTP1 250 560 700 A	75	70	5,6	ISO 10766
IGTP1 250 970 700 A	75	70	9,7	ISO 10766
IGTP1 251 500 700 A	75	70	15,0	
IGTP1 252 000 700 A	75	70	20,0	
IGTP1 252 500 700 A	75	70	25,0	
IGTP1 200 810 750 A	80	75	8,1	
IGTP1 250 560 750 A	80	75	5,6	
IGTP1 250 630 750 A	80	75	6,3	
IGTP1 250 970 750 A	80	75	9,7	
IGTP1 251 500 750 A	80	75	15,0	
IGTP1 252 000 750 A	80	75	20,0	
IGTP1 250 560 800 A	85	80	5,6	
IGTP1 250 970 800 A	85	80	9,7	ISO 10766
IGTP1 251 500 800 A	85	80	15,0	ISO 10766
IGTP1 252 500 800 A	85	80	25,0	
IGTP1 250 560 850 A	90	85	5,6	
IGTP1 250 970 850 A	90	85	9,7	
IGTP1 251 500 850 A	90	85	15,0	
IGTP1 250 970 900 A	95	90	9,7	ISO 10766
IGTP1 251 500 900 A	95	90	15,0	ISO 10766
IGTP1 252 000 900 A	95	90	20,0	
IGTP1 252 500 900 A	95	90	25,0	
IGTP1 250 970 950 A	100	95	9,7	
IGTP1 251 500 950 A	100	95	15,0	
IGTP1 252 000 950 A	100	95	20,0	
IGTP1 252 500 950 A	100	95	25,0	
IGTP1 250 971 000 A	105	100	9,7	ISO 10766
IGTP1 251 501 000 A	105	100	15,0	ISO 10766
IGTP1 252 001 000 A	105	100	20,0	
IGTP1 252 501 000 A	105	100	25,0	
IGTP1 250 971 050 A	110	105	9,7	
IGTP1 250 971 100 A	115	110	9,7	ISO 10766
IGTP1 251 501 100 A	115	110	15,0	ISO 10766
IGTP1 252 001 100 A	115	110	20,0	
IGTP1 252 501 100 A	115	110	25,0	
IGTP1 252 001 250 A	130	125	20,0	
IGTP1 251 501 600 A	165	160	15,0	ISO 10766
IGTP1 252 501 600 A	165	160	25,0	
IGTP1 251 501 800 A	185	180	15,0	ISO 10766
IGTP1 252 502 000 A	205	200	25,0	ISO 10766
IGTP1 252 502 200 A	225	220	25,0	ISO 10766

Web: <http://cat.hansa-flex.com/en/IGTP1A>

**GT**

**Guide band, GT**



Schnittansichten / Calling options

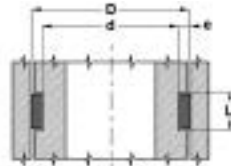

Toleranz / Tolerance		
d	D	L
H8	H9	+0,20 g

Available by the metre. Low coefficient of friction. No stick-slip. Easy working of the fitting groove and assembly.

- Design:** Guide band
- Sliding speed max.:** 15,0 m/s
- Surface pressure:** 2,5 N/mm<sup>2</sup>
- Temp. min.:** -100 °C
- Temp. max.:** 200 °C
- Media:** Mineral oils
- Installation:** insert into the groove
- Material:** PTBR

**Note:** Calculation of shear force;  $F = p \times D \times L \times n$   $F =$  maximum shear force (N)  $p =$  maximum surface pressure (N/mm<sup>2</sup>)  $D \times L =$  projected area (mm<sup>2</sup>)  $n =$  quantity of rings

**Ordering information:** For special operating conditions (fluid, temperature, pressure ...) please contact us.

Identification	e mm	L mm	Identification	e mm	L mm
GT 15 032-55	1,50	3,2	GT 25 081-55	2,50	8,1
GT 15 040-55	1,55	4,0	GT 25 097-55	2,50	9,7
GT 15 042-30	1,50	4,2	GT 25 128-55	2,50	12,8
GT 15 042-55	2,00	4,2	GT 25 150-55	2,50	15,0
GT 15 063-55	1,50	6,3	GT 25 200-55	2,50	20,0
GT 15 097-55	1,50	9,7	GT 25 250-55	2,50	25,0
GT 20 042-55	2,00	4,2	GT 25 300-55	2,50	30,0
GT 20 063-55	2,00	6,3	GT 30 096-55	3,00	9,6
GT 20 081-55	2,00	8,1	GT 30 128-55	3,00	12,8
GT 20 097-55	2,00	9,7	GT 30 150-55	3,00	15,0
GT 20 150-55	2,00	15,0	GT 30 200-55	3,00	20,0
GT 20 200-55	2,00	20,0	GT 30 250-55	3,00	25,0
GT 20 250-55	2,00	25,0	GT 30 300-55	3,00	30,0
GT 20 300-55	2,00	30,0	GT 30 400-55	3,00	40,0
GT 25 042-55	2,50	4,2	GT 40 097-55	4,00	9,7
GT 25 056-55	2,50	5,6	GT 40 250-55	4,00	25,0
GT 25 063-55	2,50	6,3			

**Web:** <http://cat.hansa-flex.com/en/GT>

**GTH**

**Guide band GTH**



Schnittansichten / Calling options

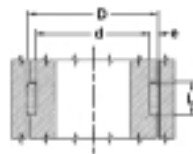

Toleranz / Tolerance		
D	d	L
H9	h8	+0,20 g

Available by the metre. Easy working of the fitting groove and assembly. Low coefficient of friction. High load-bearing capacity.

- Sliding speed max.:** 1,0 m/s
- Pressure resistance as DIN 53454 (N/mm<sup>2</sup>):** 350 N/mm<sup>2</sup>
- Surface pressure:** 50 N/mm<sup>2</sup>
- Temp. min.:** -40 °C
- Temp. max.:** 130 °C
- Media:** Mineral oils, Water emulsions
- Installation:** insert into the groove
- Material:** Guide ring: Polyester resin - synthetic fibre fabric laminate with graphite

**Note:** Calculation of shear force;  $F = p \times D \times L \times n$   $F =$  maximum shear force (N)  $p =$  maximum surface pressure (N/mm<sup>2</sup>)  $D \times L =$  projected area (mm<sup>2</sup>)  $n =$  quantity of rings

**Ordering information:** For special operating conditions (fluid, temperature, pressure ...) please contact us.

Identification	e mm	L mm	Identification	e mm	L mm
GTH 25 056	2,5	5,6	GTH 30 200	3,0	20,0
GTH 25 097	2,5	9,7	GTH 30 250	3,0	25,0
GTH 25 150	2,5	15,0	GTH 30 300	3,0	30,0
GTH 25 200	2,5	20,0	GTH 35 300	3,5	30,0
GTH 25 250	2,5	25,0	GTH 40 097	4,0	9,7
GTH 30 097	3,0	9,7	GTH 40 128	4,0	12,8
GTH 30 128	3,0	12,8	GTH 40 150	4,0	15,0
GTH 30 150	3,0	15,0	GTH 40 200	4,0	20,0
GTH 30 192	3,0	19,2	GTH 40 250	4,0	25,0

**Web:** <http://cat.hansa-flex.com/en/GTH>

Available by the metre. Easy working of the fitting groove and assembly.  
Low coefficient of friction. High load-bearing capacity.

**Sliding speed max.:** 1,0 m/s

**Pressure resistance as DIN**

**53454 (N/mm<sup>2</sup>):** 350 N/mm<sup>2</sup>

**Surface pressure:** 50 N/mm<sup>2</sup>

**Temp. min.:** -40 °C

**Temp. max.:** 130 °C

**Media:** Mineral oils, Water emulsions

**Installation:** insert into the groove

**Material:** Guide ring: Polyester resin - synthetic fibre fabric  
laminate with graphite

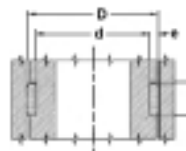

Toleranz / Tolerance		
D	d	L
H9	f8	+0,20 0



Schneidertypen / Cutting options



**Note:** Calculation of shear force;  $F = p \times D \times L \times n$   $F =$  maximum shear force (N)  $p =$  maximum surface pressure (N/mm<sup>2</sup>)  $D \times L =$  projected area (mm<sup>2</sup>)  $n =$  quantity of rings

**Ordering information:** For special operating conditions (fluid, temperature, pressure ...) please contact us.

Identification	e mm	e "	L mm	L "
GTH 31 095	3,18	1/8"	9,53	3/8"
GTH 31 127	3,18	1/8"	12,70	1/2"
GTH 31 159	3,18	1/8"	15,87	5/8"
GTH 31 191	3,18	1/8"	19,05	3/4"
GTH 31 254	3,18	1/8"	25,40	1"

**Web:** <http://cat.hansa-flex.com/en/GTHZOLL>

**WP**

**Piston guide WP**

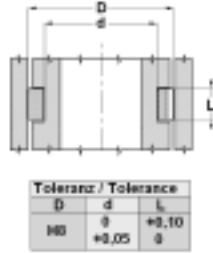
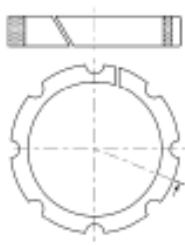

Easy working of the fitting groove and assembly. High load-bearing capacity for plunger cylinders. Note! Cannot be used as stop.

**Sliding speed max.:** 5,0 m/s

**Surface pressure:** at 20°C 15 N/mm<sup>2</sup>; at 100°C 10 N/mm<sup>2</sup>

**Temp. min.:** -30 °C

**Temp. max.:** 110 °C

**Media:** Mineral oils, Water emulsions

**Installation:** insert into the groove

**Material:** acetal resin + glass fibre

**Note:** Calculation of shear force;  $F = p \times D \times L \times n$  F= maximum shear force (N) p = maximum surface pressure (N/mm<sup>2</sup>) D x L= projected area (mm<sup>2</sup>) n= quantity of rings

Identification	D mm	d mm	L mm
WP 25	25	15	10,0
WP 30	30	20	13,0
WP 35	35	25	13,0
WP 40	40	30	13,0
WP 45	45	35	13,0

Identification	D mm	d mm	L mm
WP 55	55	45	16,0
WP 60	60	45	16,0
WP 65	65	55	16,0
WP 75	75	65	16,0
WP 85	85	75	16,0

**Web:** <http://cat.hansa-flex.com/en/WP>

Easy working of the fitting groove and assembly. High load-bearing capacity.  
Low coefficient of wear and low coefficient of friction (between 0.05 and 0.1)  
available in many sizes.

**Design:** Double guide ring  
**Sliding speed max.:** 5,0 m/s  
**Surface pressure:** at 20°C 15 N/mm<sup>2</sup>; at 100°C 10 N/mm<sup>2</sup>  
**Temp. min.:** -30 °C  
**Temp. max.:** 110 °C  
**Media:** Mineral oils  
**Installation:** insert into the groove  
**Material:** acetal resin + glass fibre

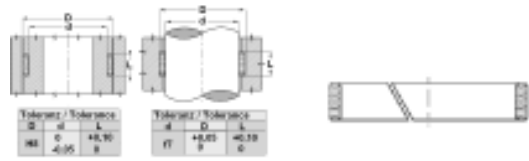

**Note:** Calculation of shear force;  $F = p \times D \times L \times n$   $F =$  maximum shear force (N)  $p =$  maximum surface pressure (N/mm<sup>2</sup>)  $D \times L =$  projected area (mm<sup>2</sup>)  $n =$  quantity of rings

**Ordering information:** We are able to produce guide rings with diameters of 20 to 510 mm with short lead times.

Identification	d	D	D	L	Identification	d	D	D	L
	mm	mm	mm	mm		mm	mm	mm	mm
WR 16-0	16		19,1	4,0	WR 65	65	70		5,6
WR 20	20	25		5,6	WR 60-2	60		65,0	15,0
WR 20-1	20	25		9,7	WR 65-1	65	70		9,7
WR 22	22		27,0	5,6	WR 67	67	75		5,6
WR 22-1	22		27,0	9,7	WR 67-1	67		72,0	9,7
WR 25-1	25	30		9,7	WR 70	70	75		5,6
WR 27	27	32		5,6	WR 70-1	70	75		9,7
WR 30	30	35		5,6	WR 70-2	70		75,0	15,0
WR 30-1	30	35		9,7	WR 75	75	80		5,6
WR 25	25		30,0	5,6	WR 70-3	70		75,0	20,0
WR 32	32	37		5,6	WR 75-1	75	80		9,7
WR 27-1	27		32,0	9,7	WR 72-1	72		77,0	9,7
WR 28	28		33,0	5,6	WR 80-1	80	85		9,7
WR 35	35	40		5,6	WR 75-2	75		80,0	15,0
WR 35-1	35	40		9,7	WR 85	85	90		5,6
WR 36-1	36	41		9,7	WR 80-2	80		85,0	15,0
WR 28-1	28		33,0	9,7	WR 85-1	85	90		9,7
WR 40	40	45		5,6	WR 80	80		85,0	5,6
WR 32-1	32		37,0	9,7	WR 83-2	83		88,0	15,0
WR 40-1	40	45		9,7	WR 95	95	100		5,6
WR 36	36		41,0	5,6	WR 85-2	85		90,0	15,0
WR 45	45	50		5,6	WR 90-1	90	95		9,7
WR 40-2	40		45,0	15,0	WR 95-1	95	100		9,7
WR 45-1	45	50		9,7	WR 90	90		95,0	5,6
WR 50	50	55		5,6	WR 92-4	92		97,0	25,0
WR 43	43		48,0	5,6	WR 95-2	95		100,0	15,0
WR 50-1	50	55		9,7	WR 100-2	100		105,0	15,0
WR 55-1	55	60		9,7	WR 100	100		105,0	5,6
WR 45-2	45		50,0	15,0	WR 100-1	100		105,0	9,7
WR 56-1	56	61		9,7	WR 105-2	105		110,0	15,0
WR 47	47		52,0	5,6	WR 105-1	105		110,0	9,7
WR 58	58	63		5,6	WR 110-2	110		115,0	15,0
WR 47-1	47		52,0	9,7	WR 110-1	110		115,0	9,7
WR 50-2	50		55,0	15,0	WR 115-1	115		120,0	9,7
WR 63	63	68		5,6	WR 120-2	120		125,0	15,0
WR 55	55		60,0	5,6	WR 120	120		125,0	5,6
WR 56	56		61,0	5,6	WR 120-1	120	125		9,7
WR 58-1	58	63		9,7	WR 125-2	125		130,0	15,0
WR 63-1	63	68		9,7	WR 135-2	135		140,0	15,0
WR 60	60	65		5,6	WR 155-2	155		160,0	15,0
WR 60-1	60	65		9,7	WR 195-2	195		200,0	15,0

**Web:** <http://cat.hansa-flex.com/en/WRFUEHRUNG>

**BK-1**

**Sliding bush BK-1**

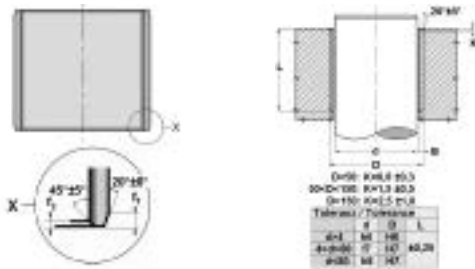

Suitable for dry running and maintenance-free. Noise and frequency absorption. hydrodynamic operation possible High permitted load. Good chemical resistance. Good friction characteristics. No stick-slip. Broad temperature range. High slide speed. No water absorption. low play during operation. Extremely space-saving.

- Design:** Maintenance-free PTFE coated friction bearing
- pv:** Continuous operation: 1.8 N/mm<sup>2</sup> x m/s, Short-term operation: 3.6 N/mm<sup>2</sup> x m/s
- Permissible load:** static: 250 N/mm<sup>2</sup>, low slide speed: 140 N/mm<sup>2</sup>, Rotation, oscillation: 55 N/mm<sup>2</sup>
- Sliding rate:** Dry running = 2 m/s, hydrodynamic operation: >2 m/s
- Thermal expansion coefficient:** parallel to ring surface: 11 x 10<sup>-6</sup> K<sup>-1</sup>, perpendicular to ring surface: 30 x 10<sup>-6</sup> K<sup>-1</sup>
- Coefficient of thermal conductivity:** > 40 W (m x K)<sup>-1</sup>
- Temp. min.:** -200 °C
- Temp. max.:** 270 °C
- Surface pressure:** 250 (≤ N/mm<sup>2</sup>)
- Material:** Steel back onto which a porous bronze layer is sintered, subsequently a PTFE lead mixture is rolled into the bronze layer
- Surface:** zinc or copper plated
- Application:** BK-1 bushes are suitable for transmission, rotational and oscillating movements, Rod guide for pneumatic and hydraulic cylinders, Attachment lugs of pneumatic and hydraulic cylinders, Conveyor-belt systems, textile machinery, automobiles ...
- Standard:** ISO 3547, DIN 1494

**Note:** Peak to valley height of shaft to be observed Ra < 0.4 µm. Hardness of shaft to be observed 350 < HB < 600.

Identification	d mm	D mm	L mm	f1 mm	f2 mm
BK-1-06 05	6	8,0	5	0,5	0,3
BK-1-06 10	6	8,0	10	0,5	0,3
BK-1-08 06	8	10,0	6	0,5	0,3
BK-1-08 10	8	10,0	10	0,5	0,3
BK-1-08 12	8	10,0	12	0,5	0,3
BK-1-10 07	10	12,0	7	0,5	0,3
BK-1-10 08	10	12,0	8	0,5	0,3
BK-1-10 10	10	12,0	10	0,5	0,3
BK-1-10 12	10	12,0	12	0,5	0,3
BK-1-10 15	10	12,0	15	0,5	0,3
BK-1-10 20	10	12,0	20	0,5	0,3
BK-1-12 08	12	14,0	8	0,5	0,3
BK-1-12 12	12	14,0	12	0,5	0,3
BK-1-12 15	12	14,0	15	0,5	0,3
BK-1-12 20	12	14,0	20	0,5	0,3
BK-1-12 25	12	14,0	25	0,5	0,3
BK-1-13 10	13	15,0	10	0,5	0,3
BK-1-14 25	14	16,0	25	0,5	0,3
BK-1-15 10	15	17,0	10	0,5	0,3
BK-1-15 12	15	17,0	12	0,5	0,3
BK-1-15 15	15	17,0	15	0,5	0,3
BK-1-15 20	15	17,0	20	0,5	0,3
BK-1-15 25	15	17,0	25	0,5	0,3
BK-1-16 15	16	18,0	15	0,5	0,3
BK-1-16 20	16	18,0	20	0,5	0,3
BK-1-16 25	16	18,0	25	0,5	0,3
BK-1-17 12	17	19,0	12	0,5	0,3
BK-1-18 15	18	20,0	15	0,5	0,3
BK-1-18 20	18	20,0	20	0,5	0,3
BK-1-18 25	18	20,0	25	0,5	0,3
BK-1-20 10	20	23,0	10	0,8	0,4
BK-1-20 20	20	23,0	20	0,8	0,4
BK-1-20 25	20	23,0	25	0,8	0,4
BK-1-20 30	20	23,0	30	0,8	0,4
BK-1-22 20	22	25,0	20	0,8	0,4
BK-1-22 25	22	25,0	25	0,8	0,4
BK-1-22 30	22	25,0	30	0,8	0,4
BK-1-24 15	24	27,0	15	0,8	0,4
BK-1-24 25	24	27,0	25	0,8	0,4
BK-1-24 30	24	27,0	30	0,8	0,4
BK-1-25 12	25	28,0	12	0,8	0,4
BK-1-25 15	25	28,0	15	0,8	0,4
BK-1-25 20	25	28,0	20	0,8	0,4
BK-1-25 25	25	28,0	25	0,8	0,4
BK-1-25 30	25	28,0	30	0,8	0,4
BK-1-25 35	25	28,0	35	0,8	0,4
BK-1-25 40	25	28,0	40	0,8	0,4
BK-1-25 50	25	28,0	50	0,8	0,4
BK-1-26 20	26	29,0	20	1,0	0,5





(Continued)

BK-1

## Sliding bush BK-1

Identification	d mm	D mm	L mm	f1 mm	f2 mm
BK-1- 26 30	26	29,0	30	1,0	0,5
BK-1- 28 20	28	32,0	20	1,0	0,5
BK-1- 28 25	28	32,0	25	1,0	0,5
BK-1- 28 30	28	32,0	30	1,0	0,5
BK-1- 28 35	28	32,0	35	1,0	0,5
BK-1- 30 12	30	34,0	12	1,0	0,5
BK-1- 30 15	30	34,0	15	1,0	0,5
BK-1- 30 20	30	34,0	20	1,0	0,5
BK-1- 30 25	30	34,0	25	1,0	0,5
BK-1- 30 30	30	34,0	30	1,0	0,5
BK-1- 30 35	30	34,0	35	1,0	0,5
BK-1- 30 40	30	34,0	40	1,0	0,5
BK-1- 32 20	32	36,0	20	1,0	0,5
BK-1- 32 25	32	36,0	25	1,0	0,5
BK-1- 32 30	32	36,0	30	1,0	0,5
BK-1- 32 40	32	36,0	40	1,0	0,5
BK-1- 35 20	35	39,0	20	1,0	0,5
BK-1- 35 25	35	39,0	25	1,0	0,5
BK-1- 35 30	35	39,0	30	1,0	0,5
BK-1- 35 35	35	39,0	35	1,0	0,5
BK-1- 35 40	35	39,0	40	1,0	0,5
BK-1- 35 50	35	39,0	50	1,0	0,5
BK-1- 38 20	38	42,0	20	1,0	0,5
BK-1- 38 40	38	42,0	40	1,0	0,5
BK-1- 40 12	40	44,0	12	1,0	0,5
BK-1- 40 20	40	44,0	20	1,0	0,5
BK-1- 40 25	40	44,0	25	1,0	0,5
BK-1- 40 30	40	44,0	30	1,0	0,5
BK-1- 40 35	40	44,0	35	1,0	0,5
BK-1- 40 40	40	44,0	40	1,0	0,5
BK-1- 40 50	40	44,0	50	1,0	0,5
BK-1- 45 20	45	50,0	20	1,2	0,6
BK-1- 45 25	45	50,0	25	1,2	0,6
BK-1- 45 30	45	50,0	30	1,2	0,6
BK-1- 45 35	45	50,0	35	1,2	0,6
BK-1- 45 40	45	50,0	40	1,2	0,6
BK-1- 45 45	45	50,0	45	1,2	0,6
BK-1- 45 50	45	50,0	50	1,2	0,6
BK-1- 50 15	50	55,0	15	1,2	0,6
BK-1- 50 20	50	55,0	20	1,2	0,6
BK-1- 50 25	50	55,0	25	1,2	0,6
BK-1- 50 30	50	55,0	30	1,2	0,6
BK-1- 50 35	50	55,0	35	1,2	0,6
BK-1- 50 40	50	55,0	40	1,2	0,6
BK-1- 50 50	50	55,0	50	1,2	0,6
BK-1- 50 60	50	55,0	60	1,2	0,6
BK-1- 55 30	55	60,0	30	1,2	0,6
BK-1- 55 35	55	60,0	35	1,2	0,6
BK-1- 55 40	55	60,0	40	1,2	0,6
BK-1- 55 50	55	60,0	50	1,2	0,6
BK-1- 55 60	55	60,0	60	1,2	0,6
BK-1- 60 30	60	65,0	30	1,2	0,6
BK-1- 60 40	60	65,0	40	1,2	0,6
BK-1- 60 50	60	65,0	50	1,2	0,6
BK-1- 60 60	60	65,0	60	1,2	0,6
BK-1- 60 70	60	65,0	70	1,2	0,6
BK-1- 65 40	65	70,0	40	1,2	0,6
BK-1- 65 50	65	70,0	50	1,2	0,6
BK-1- 65 60	65	70,0	60	1,2	0,6
BK-1- 65 70	65	70,0	70	1,2	0,6
BK-1- 70 30	70	75,0	30	1,2	0,6
BK-1- 70 40	70	75,0	40	1,2	0,6
BK-1- 70 60	70	75,0	60	1,2	0,6
BK-1- 70 70	70	75,0	70	1,2	0,6
BK-1- 75 30	75	80,0	30	1,2	0,6
BK-1- 75 50	75	80,0	50	1,2	0,6
BK-1- 75 60	75	80,0	60	1,2	0,6
BK-1- 80 40	80	85,0	40	1,2	0,6
BK-1- 80 60	80	85,0	60	1,2	0,6
BK-1- 80 80	80	85,0	80	1,2	0,6
BK-1- 80 100	80	85,0	100	1,2	0,6
BK-1- 85 40	85	90,0	40	1,2	0,6
BK-1- 90 40	90	95,0	40	1,2	0,6
BK-1- 90 60	90	95,0	60	1,2	0,6
BK-1- 90 100	90	95,0	100	1,2	0,6
BK-1- 100 50	100	105,0	50	1,2	0,6
BK-1- 100 60	100	105,0	60	1,2	0,6
BK-1- 100 95	100	105,0	95	1,2	0,6
BK-1- 110 50	110	115,0	50	1,2	0,6
BK-1- 110 60	110	115,0	60	1,2	0,6
BK-1- 120 60	120	125,0	60	1,2	0,6
BK-1- 120 100	120	125,0	100	1,2	0,6
BK-1- 125 100	125	130,0	100	1,2	0,6
BK-1- 140 80	140	145,0	80	1,2	0,6
BK-1- 160 80	160	165,0	80	1,2	0,6
BK-1- 160 100	160	165,0	100	1,2	0,6

Web: <http://cat.hansa-flex.com/en/BK1>

## BK-1 F

## Sliding bush BK-1-F

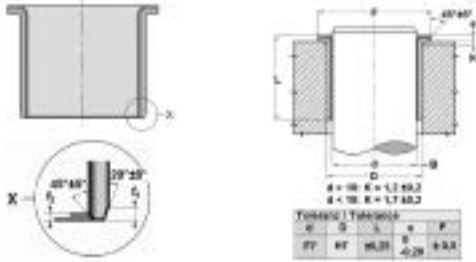

Suitable for dry running and maintenance-free. Noise and frequency absorption. hydrodynamic operation possible. High permitted load. Good chemical resistance. Good friction characteristics. No stick-slip. Broad temperature range. High slide speed. No water absorption. low play during operation. Extremely space-saving.

<b>Design:</b>	Maintenance-free PTFE coated friction bearing
<b>p<sub>v</sub>:</b>	Continuous operation: 1.8 N/mm <sup>2</sup> x m/s, Short-term operation: 3.6 N/mm <sup>2</sup> x m/s
<b>Permissible load:</b>	static: 250 N/mm <sup>2</sup> , low slide speed: 140 N/mm <sup>2</sup> , Rotation, oscillation: 55 N/mm <sup>2</sup>
<b>Sliding rate:</b>	Dry running = 2 m/s, hydrodynamic operation: >2 m/s
<b>Thermal expansion coefficient:</b>	parallel to ring surface: 11 x 10 <sup>-6</sup> K <sup>-1</sup> , perpendicular to ring surface: 30 x 10 <sup>-6</sup> K <sup>-1</sup>
<b>Coefficient of thermal conductivity:</b>	> 40 W (m x K) <sup>-1</sup>
<b>Temp. min.:</b>	-200 °C
<b>Temp. max.:</b>	270 °C
<b>Surface pressure:</b>	250 (≤ N/mm <sup>2</sup> )
<b>Material:</b>	Steel back onto which a porous bronze layer is sintered, subsequently a PTFE lead mixture is rolled into the bronze layer
<b>Surface:</b>	zinc or copper plated
<b>Application:</b>	BK-1 bushes are suitable for transmission, rotational and oscillating movements, Rod guide for pneumatic and hydraulic cylinders, Attachment lugs of pneumatic and hydraulic cylinders, Conveyor-belt systems, textile machinery, automobiles ...
<b>Standard:</b>	ISO 3547, DIN 1494

**Note:** Peak to valley height of shaft to be observed Ra < 0.4 μm. Hardness of shaft to be observed 350 < HB < 600.

Identification	d mm	D mm	L mm	e mm	F mm	f1 mm	f2 mm
BK-1-06 070 F	6	8	7,0	1,0	12	0,5	0,3
BK-1-10 120 F	10	12	12,0	1,0	18	0,5	0,3
BK-1-12 120 F	12	14	12,0	1,0	20	0,5	0,3
BK-1-14 120 F	14	16	12,0	1,0	22	0,5	0,3
BK-1-15 120 F	15	17	12,0	1,0	23	0,5	0,3
BK-1-15 170 F	15	17	17,0	1,0	23	0,5	0,3
BK-1-18 120 F	18	20	12,0	1,0	26	0,5	0,3
BK-1-18 170 F	18	20	17,0	1,0	26	0,5	0,3
BK-1-20 115 F	20	23	11,5	1,5	31	0,8	0,4
BK-1-20 165 F	20	23	16,5	1,5	31	0,8	0,4
BK-1-20 215 F	20	23	21,5	1,5	31	0,8	0,4
BK-1-25 165 F	25	28	16,5	1,5	36	0,8	0,4
BK-1-25 215 F	25	28	21,5	1,5	36	0,8	0,4
BK-1-30 160 F	30	34	16,0	2,0	42	1,0	0,5
BK-1-30 260 F	30	34	26,0	2,0	42	1,0	0,5
BK-1-35 160 F	35	39	16,0	2,0	49	1,0	0,5
BK-1-35 260 F	35	39	26,0	2,0	49	1,0	0,5

**Web:** <http://cat.hansa-flex.com/en/BK1F>

## Sliding bush BK-2

Maintenance-free operation. Noise and frequency absorption. Multi-lubrication. hydrodynamic operation possible High permitted load. Good friction characteristics. High slide speed. No water absorption. To be used when oil film formation difficult. low play during operation. Extremely space-saving.

<b>Design:</b>	Multi-lubrication, POM coated friction bearing with lubrication pockets
<b>Construction type:</b>	Operation with lubrication: 5 N/mm <sup>2</sup> x m/s
<b>pv:</b>	static: 140 N/mm <sup>2</sup> , Rotation, oscillation: 70 N/mm <sup>2</sup>
<b>Permissible load:</b>	
<b>Sliding rate:</b>	Dry running = 2 m/s, hydrodynamic operation: 5 m/s
<b>Friction coefficient:</b>	dry: 0.15 to 0.25, lubricated: 0.05 to 0.15
<b>Thermal expansion coefficient:</b>	parallel to ring surface: 11 x 10 <sup>-6</sup> K <sup>-1</sup> , perpendicular to ring surface: 48 x 10 <sup>-6</sup> K <sup>-1</sup>
<b>Coefficient of thermal conductivity:</b>	> 32 W (m x K) <sup>-1</sup>
<b>Temp. min.:</b>	-20 °C
<b>Temp. max.:</b>	100 °C
<b>Surface pressure:</b>	140 (≤ N/mm <sup>2</sup> )
<b>Material:</b>	Steel back onto which a porous bronze layer is sintered, subsequently the acetal resin POM is rolled into the bronze layer
<b>Surface:</b>	zinc or copper plated
<b>Application:</b>	BK-2 bushes are suitable for rotational and oscillating movements, Attachment lugs of pneumatic and hydraulic cylinders, Conveyor-belt systems, textile machinery, automobiles ...
<b>Standard:</b>	ISO 3547, DIN 1494

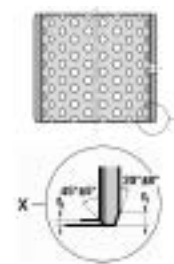
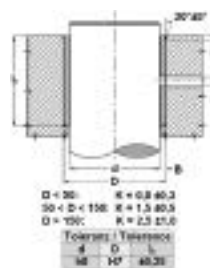

**Note:** An initial lubrication with grease is recommended and continual lubrication significantly increases the service life of the friction bearing. Peak to valley height of shaft to be observed Ra < 0.8 μm. Hardness of shaft to be observed 200 < HB < 600.

Identification	d mm	D mm	L mm	f1 mm	f2 mm	g mm
BK-2- 10 20	10	12	20	0,5	0,3	4,0
BK-2- 15 25	15	17	25	0,5	0,3	4,0
BK-2- 20 15	20	23	15	0,8	0,4	4,0
BK-2- 20 20	20	23	20	0,8	0,4	4,0
BK-2- 20 25	20	23	25	0,8	0,4	4,0
BK-2- 20 30	20	23	30	0,8	0,4	4,0
BK-2- 22 25	22	25	25	0,8	0,4	6,0
BK-2- 22 30	22	25	30	0,8	0,4	6,0
BK-2- 24 15	24	27	15	0,8	0,4	6,0
BK-2- 24 25	24	27	25	0,8	0,4	6,0
BK-2- 25 15	25	28	15	0,8	0,4	6,0
BK-2- 25 20	25	28	20	0,8	0,4	6,0
BK-2- 25 25	25	28	25	0,8	0,4	6,0
BK-2- 25 30	25	28	30	0,8	0,4	6,0
BK-2- 28 25	28	32	25	1,0	0,5	6,0
BK-2- 28 30	28	32	30	1,0	0,5	6,0
BK-2- 30 20	30	34	20	1,0	0,5	6,0
BK-2- 30 30	30	34	30	1,0	0,5	6,0
BK-2- 30 40	30	34	40	1,0	0,5	6,0
BK-2- 32 25	32	36	25	1,0	0,5	6,0
BK-2- 32 30	32	36	30	1,0	0,5	6,0
BK-2- 32 40	32	36	40	1,0	0,5	6,0
BK-2- 35 20	35	39	20	1,0	0,5	6,0
BK-2- 35 30	35	39	30	1,0	0,5	6,0
BK-2- 35 35	35	39	35	1,0	0,5	6,0
BK-2- 35 40	35	39	40	1,0	0,5	6,0
BK-2- 35 50	35	39	50	1,0	0,5	6,0
BK-2- 40 20	40	44	20	1,0	0,5	8,0
BK-2- 40 30	40	44	30	1,0	0,5	8,0
BK-2- 40 40	40	44	40	1,0	0,5	8,0
BK-2- 40 50	40	44	50	1,0	0,5	8,0
BK-2- 45 30	45	50	30	1,2	0,6	8,0
BK-2- 45 40	45	50	40	1,2	0,6	8,0
BK-2- 45 45	45	50	45	1,2	0,6	8,0
BK-2- 45 50	45	50	50	1,2	0,6	8,0
BK-2- 50 30	50	55	30	1,2	0,6	8,0
BK-2- 50 35	50	55	35	1,2	0,6	8,0
BK-2- 50 40	50	55	40	1,2	0,6	8,0
BK-2- 50 50	50	55	50	1,2	0,6	8,0
BK-2- 50 60	50	55	60	1,2	0,6	8,0
BK-2- 55 40	55	60	40	1,2	0,6	8,0
BK-2- 55 60	55	60	60	1,2	0,6	8,0
BK-2- 60 30	60	65	30	1,2	0,6	8,0
BK-2- 60 40	60	65	40	1,2	0,6	8,0
BK-2- 60 50	60	65	50	1,2	0,6	8,0
BK-2- 60 60	60	65	60	1,2	0,6	8,0
BK-2- 60 70	60	65	70	1,2	0,6	8,0

## BK-2

(Continued)

## Sliding bush BK-2

Identification	d mm	D mm	L mm	f1 mm	f2 mm	g mm
BK-2- 65 60	65	70	60	1,2	0,6	8,0
BK-2- 70 30	70	75	30	1,2	0,6	8,0
BK-2- 70 40	70	75	40	1,2	0,6	8,0
BK-2- 70 50	70	75	50	1,2	0,6	8,0
BK-2- 70 70	70	75	70	1,2	0,6	8,0
BK-2- 70 80	70	75	80	1,2	0,6	8,0
BK-2- 75 40	75	80	40	1,2	0,6	9,5
BK-2- 80 40	80	85	40	1,2	0,6	9,5
BK-2- 80 50	80	85	50	1,2	0,6	9,5
BK-2- 80 60	80	85	60	1,2	0,6	9,5
BK-2- 80 80	80	85	80	1,2	0,6	9,5
BK-2- 85 60	85	90	60	1,2	0,6	9,5
BK-2- 90 40	90	95	40	1,2	0,6	9,5
BK-2- 90 60	90	95	60	1,2	0,6	9,5
BK-2- 90 80	90	95	80	1,2	0,6	9,5
BK-2- 90 90	90	95	90	1,2	0,6	9,5
BK-2- 95 60	95	100	60	1,2	0,6	9,5
BK-2- 100 60	100	105	60	1,2	0,6	9,5
BK-2- 110 60	110	115	60	1,2	0,6	9,5
BK-2- 120 60	120	125	60	1,2	0,6	9,5
BK-2- 125 60	125	130	60	1,2	0,6	9,5
BK-2- 130 60	130	135	60	1,2	0,6	9,5
BK-2- 130 80	130	135	80	1,2	0,6	9,5

**Web:** <http://cat.hansa-flex.com/en/BK2>

## Sliding bush BK090

Maintenance-free operation. Multi-lubricationable. Not suitable for dirty conditions. Shock and vibration resistant. High permitted load. Good friction characteristics. No water absorption. low play during operation. Extremely space-saving.

<b>Design:</b>	Multi-lubrication friction bearing in rolled bronze
<b>Construction type:</b>	The bushes are suitable for rotational and oscillating movements
<b>pv:</b>	for grease lubrication: $2.8 \text{ N/mm}^2 \times \text{m/s}$ , for oil lubrication: $10 \text{ N/mm}^2 \times \text{m/s}$
<b>Permissible load:</b>	static: $140 \text{ N/mm}^2$ , Rotation, oscillation: $70 \text{ N/mm}^2$
<b>Sliding speed max.:</b>	1,0 m/s
<b>Friction coefficient:</b>	lubricated: 0.05 to 0.15
<b>Thermal expansion coefficient:</b>	$11 \times 10^{-6} \text{ K}^{-1}$
<b>Coefficient of thermal conductivity:</b>	$> 60 \text{ W (m x K)}^{-1}$
<b>Temp. min.:</b>	-50 °C
<b>Temp. max.:</b>	150 °C
<b>Surface pressure:</b>	$140 (\leq \text{N/mm}^2)$
<b>Material:</b>	CuSn8 bronze
<b>Application:</b>	Hydraulics
<b>Standard:</b>	ISO 3547, DIN 1494

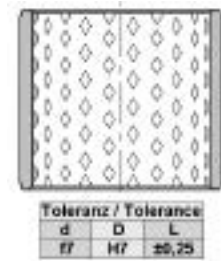
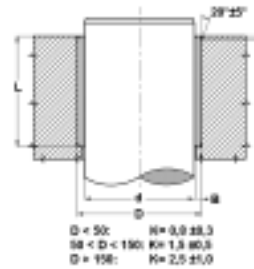

**Note:** An initial lubrication with grease is recommended and continual lubrication significantly increases the service life of the friction bearing. Peak to valley height of shaft to be observed  $R_a < 0.8 \mu\text{m}$ . Hardness of shaft to be observed  $150 < \text{HB} < 600$ .

Identification	d mm	D mm	L mm
BK 090-10 10	10	12	10
BK 090-14 15	14	16	15
BK 090-15 15	15	17	15
BK 090-16 20	16	18	20
BK 090-16 25	16	18	25
BK 090-18 15	18	21	15
BK 090-20 15	20	23	15
BK 090-20 20	20	23	20
BK 090-20 25	20	23	25
BK 090-20 30	20	23	30
BK 090-22 20	22	25	20
BK 090-22 25	22	25	25
BK 090-22 30	22	25	30
BK 090-25 15	25	28	15
BK 090-25 20	25	28	20
BK 090-25 25	25	28	25
BK 090-25 30	25	28	30
BK 090-28 20	28	31	20
BK 090-28 25	28	31	25
BK 090-28 30	28	31	30
BK 090-30 20	30	34	20
BK 090-30 25	30	34	25
BK 090-30 30	30	34	30
BK 090-30 40	30	34	40
BK 090-32 20	32	36	20
BK 090-32 30	32	36	30
BK 090-32 40	32	36	40
BK 090-35 15	35	39	15
BK 090-35 20	35	39	20
BK 090-35 30	35	39	30
BK 090-35 35	35	39	35
BK 090-35 40	35	39	40
BK 090-35 50	35	39	50
BK 090-40 20	40	44	20
BK 090-40 25	40	44	25
BK 090-40 30	40	44	30
BK 090-40 40	40	44	40
BK 090-40 50	40	44	50
BK 090-45 20	45	50	20
BK 090-45 25	45	50	25
BK 090-45 30	45	50	30
BK 090-45 40	45	50	40
BK 090-45 50	45	50	50
BK 090-45 60	45	50	60
BK 090-50 30	50	55	30
BK 090-50 40	50	55	40
BK 090-50 50	50	55	50
BK 090-50 60	50	55	60
BK 090-55 20	55	60	20
BK 090-55 40	55	60	40
BK 090-55 50	55	60	50
BK 090-55 60	55	60	60
BK 090-60 30	60	65	30
BK 090-60 35	60	65	35
BK 090-60 40	60	65	40
BK 090-60 50	60	65	50
BK 090-60 60	60	65	60



## BK 090

(Continued)

## Sliding bush BK090

Identification	d mm	D mm	L mm
BK 090-65 40	65	70	40
BK 090-65 50	65	70	50
BK 090-65 60	65	70	60
BK 090-70 40	70	75	40
BK 090-70 50	70	75	50
BK 090-70 60	70	75	60
BK 090-70 70	70	75	70
BK 090-70 80	70	75	80
BK 090-75 40	75	80	40
BK 090-75 60	75	80	60
BK 090-75 80	75	80	80
BK 090-80 40	80	85	40
BK 090-80 50	80	85	50
BK 090-80 60	80	85	60
BK 090-80 80	80	85	80
BK 090-85 40	85	90	40
BK 090-85 80	85	90	80
BK 090-90 50	90	95	50
BK 090-90 60	90	95	60
BK 090-90 90	90	95	90
BK 090-100 50	100	105	50
BK 090-100 60	100	105	60
BK 090-110 60	110	115	60
BK 090-120 50	120	125	50
BK 090-130 60	130	135	60
BK 090-130 100	130	135	100
BK 090-140 100	140	145	100
BK 090-150 60	150	155	60
BK 090-180 60	180	185	60

Web: <http://cat.hansa-flex.com/en/BK090>

## BK 090 F

## Sliding bush BK090-F

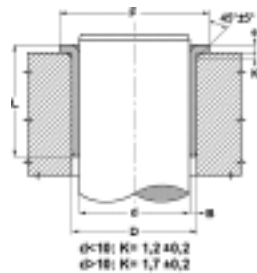
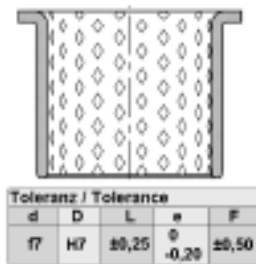

Maintenance-free operation. Multi-lubricationable. Not suitable for dirty conditions. Shock and vibration resistant. High permitted load. Good friction characteristics. No water absorption. low play during operation. Extremely space-saving.

<b>Design:</b>	Multi-lubrication friction bearing in rolled bronze
<b>Construction type:</b>	The bushes are suitable for rotational and oscillating movements
<b>pv:</b>	for grease lubrication: 2.8 N/mm <sup>2</sup> x m/s, for oil lubrication: 10 N/mm <sup>2</sup> x m/s
<b>Permissible load:</b>	static: 140 N/mm <sup>2</sup> , Rotation, oscillation: 70 N/mm <sup>2</sup>
<b>Sliding speed max.:</b>	1,0 m/s
<b>Friction coefficient:</b>	lubricated: 0.05 to 0.15
<b>Thermal expansion coefficient:</b>	11 x 10 <sup>-6</sup> K <sup>-1</sup>
<b>Coefficient of thermal conductivity:</b>	> 60 W (m x K) <sup>-1</sup>
<b>Temp. min.:</b>	-50 °C
<b>Temp. max.:</b>	150 °C
<b>Surface pressure:</b>	140 (≤ N/mm <sup>2</sup> )
<b>Material:</b>	CuSn8 bronze
<b>Application:</b>	Hydraulics
<b>Standard:</b>	ISO 3547, DIN 1494

**Note:** An initial lubrication with grease is recommended and continual lubrication significantly increases the service life of the friction bearing. Peak to valley height of shaft to be observed Ra < 0.8 µm. Hardness of shaft to be observed 150 < HB < 600.

Identification	d mm	D mm	L mm	e mm	F mm
BK 090-25 25 F	25	28	25	1,5	35
BK 090-30 30 F	30	34	30	2,0	45
BK 090-35 35 F	35	39	35	2,0	50
BK 090-40 40 F	40	44	40	2,0	55
BK 090-45 30 F	45	50	30	2,5	60
BK 090-50 50 F	50	55	50	2,5	65
BK 090-60 30 F	60	65	30	2,5	75
BK 090-60 60 F	60	65	60	2,5	75
BK 090-60 65 F	60	65	65	2,5	75
BK 090-65 30 F	65	70	30	2,5	80
BK 090-70 40 F	70	75	40	2,5	85
BK 090-70 70 F	70	75	70	2,5	85
BK 090-80 40 F	80	85	40	2,5	100
BK 090-80 80 F	80	85	80	2,5	100

(Continued)

BK 090 F

## Sliding bush BK090-F

Identification	d mm	D mm	L mm	e mm	F mm
BK 090-90 90 F	90	95	90	2,5	110
BK 090-120 90 F	120	125	90	2,5	140

**Web:** <http://cat.hansa-flex.com/en/BK090F>



**Pneumatic seals**



**Rod seals Pneumatic**

Dampinp saels type CIM	136
Rod U-ring, DDI, DDIM, DDIM-P	137
U-rings, DUM, DUM-N	139
Rod wiper seals type NPSL, NPSL-P	140

**Piston seals Pneumatic**

Piston groove rings type DDE, DDEM, DDEM-P	141
U-rings, DUM, DUM-N	142
Sets of groove ring seals type GPP	142
Complete pistons pneumatics type TDOP	142

**CIM**

**Damping seal**

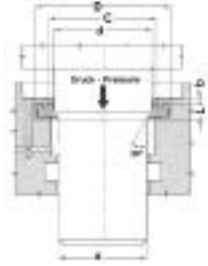

Toleranz / Tolerance				
d	D	C	L	b
h10	H11	H11	+/-0,1	+0,2 0

Low spatial requirement. Easy fitting without special tools High abrasion resistance. Low dynamic friction. Long service life.

**Operating pressure:** up to 16 bar

**Sliding speed max.:** 1,0 m/s

**Temp. min.:** -30 °C

**Temp. max.:** 80 °C

**Media:** Air, Mineral oils

**Material:**

Identification	d	D	C	L	a	b
	mm	mm	mm	mm	mm	mm
K-D CIM 6	6,0	10,0	8,0	3,7	4,5	2,0
K-D CIM 8	8,0	11,6	10,0	3,3	7,0	2,0
K-D CIM 9	9,5	15,0	12,0	4,5	8,0	2,0
K-D CIM 10	10,0	18,0	15,0	7,0	8,0	2,0
K-D CIM 12	12,0	18,0	15,5	4,8	10,0	2,0
K-D CIM 12/1	12,0	20,0	17,0	7,0	10,0	2,0
K-D CIM 14	14,0	22,0	19,0	7,0	12,0	2,0
K-D CIM 16	16,0	22,0	21,0	7,0	14,0	2,0
K-D CIM 16/1	16,0	24,0	21,0	7,0	14,0	2,0
K-D CIM 18	18,0	26,0	23,0	7,0	16,0	2,0
K-D CIM 20	20,0	28,0	24,0	7,0	17,5	2,0
K-D CIM 22	22,0	30,0	26,0	7,0	19,5	2,0
K-D CIM 25	25,0	33,0	29,0	7,0	22,5	2,0
K-D CIM 28	28,0	36,0	32,0	7,0	22,5	2,0
K-D CIM 30	30,0	40,0	35,0	7,0	27,5	2,0
K-D CIM 32	32,0	42,0	37,0	7,0	29,0	2,0
K-D CIM 36	36,0	46,0	41,0	7,0	33,0	2,0
K-D CIM 40	40,0	50,0	45,0	7,0	37,0	2,0
K-D CIM 50	50,0	60,0	55,0	7,0	47,0	2,0

**Web:** <http://cat.hansa-flex.com/en/CIM>

## DDI

## Rod seal DDI

Low-friction seal. Simple solution.

**Design:** Rod U-ring  
**Operating pressure:** up to 120 bar  
**Sliding speed max.:** 0,5 m/s  
**Design:** Inches  
**Temp. min.:** -30 °C  
**Temp. max.:** 100 °C  
**Media:** Mineral oils, Water-air  
**Installation:** in closed grooves A, in open grooves B  
**Material:** NBR 90° Shore A  
**Application:** Hydraulics + pneumatics



Toleranz / Tolerance		
d	D	L
H8 / f7	H9	+0,5 0

**Note:** Dimensions see page Rod seals ...

**Ordering information:** Other sizes on request We are able to produce seals with diameters of 20 to 510 mm with short lead times.

**Web:** <http://cat.hansa-flex.com/en/DDIDITSTANGENPNEU>

2

## DDIM

## Rod seal DDIM

Low-friction seal. Simple solution.

**Design:** Rod U-ring  
**Operating pressure:** up to 120 bar  
**Sliding speed max.:** 0,5 m/s  
**Design:** Metric  
**Temp. min.:** -30 °C  
**Temp. max.:** 100 °C  
**Media:** Mineral oils, Water-air  
**Installation:** in closed grooves A, in open grooves B  
**Material:** NBR 90° Shore A  
**Application:** Hydraulics + pneumatics



Toleranz / Tolerance		
d	D	L
H8 / f7	H9	+0,5 0

**Note:** Dimensions see page Rod seals ...

**Ordering information:** Other sizes on request

**Web:** <http://cat.hansa-flex.com/en/DDIMDITSTANGENPNEU>

**Product versions:**

DDIM P - Rod seal DDIM-P, PUR 90° Shore A

**DDIM P****Rod seal DDIM-P**

Toleranz / Tolerance		
d	D	L
H8 / f7	H9	+0,3 0

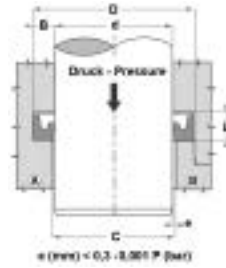

Low-friction seal. Simple solution.

- Design:** Rod lip seal  
**Operating pressure:** up to 16 bar  
**Sliding speed max.:** 1,0 m/s  
**Temp. min.:** -30 °C  
**Temp. max.:** 80 °C  
**Media:** Air  
**Installation:** in closed grooves A, in open grooves B  
**Material:** PUR 90° Shore A  
**Application:** Hydraulics + pneumatics

**Note:** Dimensions see page Rod seals ...

**Ordering information:** Other sizes on request

**Web:** <http://cat.hansa-flex.com/en/DDIMPDITSTANGENPNEU>

**Product versions:**

**DDIM** - Rod seal DDIM, NBR 90° Shore A

## DUM

## U-ring DUM

Low-friction seal. Simple solution. For rods and pistons.

- Design:** U-ring  
**Operating pressure:** up to 120 bar  
**Sliding speed max.:** 0,5 m/s  
**Design:** Metric  
**Temp. min.:** -30 °C  
**Temp. max.:** 100 °C  
**Media:** Mineral oils, Water-air  
**Installation:** on one-piece pistons A, on multi-part pistons B  
**Material:** Seal: NBR 90° Shore A  
**Application:** Hydraulics + pneumatics

**Note:** Dimensions see page Rod seals ...

**Ordering information:** We are able to produce seals with diameters of 20 to 510 mm with short lead times.

**Web:** <http://cat.hansa-flex.com/en/DUMDITSTANGENPNEU>

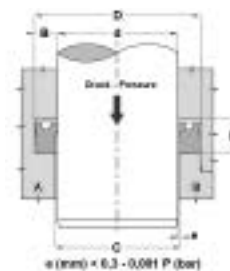

Toleranz / Tolerance		
d	D	L
H8 / f7	H9	+0.5 0

## NPSL

### Combination element NPSL



Toleranz / Tolerance				
d	D	h	A	E
H8 / f8	H7	± 0,10	+0,30 0	+0,25 0

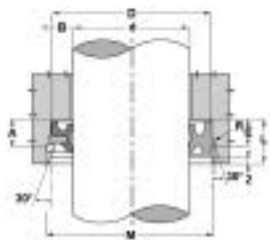

Low-friction seal. Combination element, seal/wiper.

- Design:** Rod wiper seal
- Operating pressure:** up to 10 bar
- Sliding speed max.:** 1,0 m/s
- Temp. min.:** -30 °C
- Temp. max.:** 90 °C
- Media:** Mineral oils, Water-air
- Installation:** in open grooves B
- Material:** NBR 75° Shore A
- Application:** Pneumatics

Identification	d	D	h	H	M	A	R
	mm	mm	mm	mm	mm	mm	mm
NPSL 16 26-7	16	26	7,0	9,5	28,00	8,50	1,10
NPSL 18 26-6	18	26	6,0	8,5	28,00	7,50	1,10
NPSL 20 30-7	20	30	7,0	9,5	32,00	8,80	1,40
NPSL 22 32-7	22	32	7,0	9,5	34,50	8,80	1,40
NPSL 25 35-7	25	35	7,0	9,5	37,50	8,80	1,40
NPSL 30 40-7	30	40	7,0	9,5	42,50	8,80	1,40
NPSL 32 42-7	32	42	7,0	9,5	44,50	8,80	1,40
NPSL 40 50-7	40	50	7,0	9,5	52,50	8,80	1,40

Web: <http://cat.hansa-flex.com/en/NPSL>

## NPSL-P

### Combination element NPSL-P

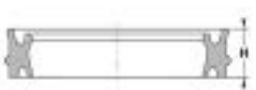

Toleranz / Tolerance				
d	D	h	A	E
H8 / f8	H7	± 0,10	+0,20 0	+0,25 0

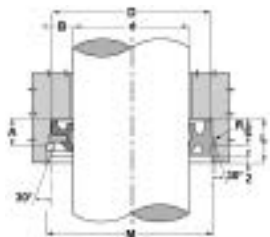

Low-friction seal. Combination element, seal/wiper.

- Design:** Rod wiper seal
- Operating pressure:** up to 10 bar
- Sliding speed max.:** 1,0 m/s
- Temp. min.:** -30 °C
- Temp. max.:** 90 °C
- Media:** Mineral oils, Water-air
- Installation:** in open grooves B
- Material:** Polyurethane 93° Shore A
- Application:** Pneumatics

Identification	d	D	h	H	L	M	E	R
	mm	mm	mm	mm	mm	mm	mm	mm
NPSL-P 12	12	22	7,0	10,4	13	24,20	8,80	1,10
NPSL-P 16	16	26	7,0	10,4	13	28,20	8,80	1,10
NPSL-P 18	18	28	7,0	10,4	13	30,20	8,80	1,10
NPSL-P 20	20	30	7,0	10,4	13	32,20	8,80	1,40
NPSL-P 22	22	32	7,3	10,4	14	34,80	9,40	1,40
NPSL-P 25	25	35	7,3	10,4	14	37,80	9,40	1,40
NPSL-P 30	30	40	7,3	10,4	14	42,80	9,40	1,40
NPSL-P 32	32	42	7,3	10,4	14	44,80	9,40	1,40
NPSL-P 40	40	50	7,3	10,4	14	52,80	9,40	1,40
NPSL-P 45	45	55	7,7	10,4	15	58,60	10,40	1,80

Web: <http://cat.hansa-flex.com/en/NPSLP>

## DDE

## Piston seal, DDE

Low-friction seal. Simple solution.

**Design:** Piston U-ring  
**Operating pressure:** up to 80 bar  
**Sliding speed max.:** 0,5 m/s  
**Design:** Inches  
**Temp. min.:** -30 °C  
**Temp. max.:** 100 °C  
**Media:** Mineral oils, Water-air  
**Installation:** on one-piece pistons A, on multi-part pistons B  
**Material:** NBR 75° Shore A  
**Application:** Hydraulics + pneumatics

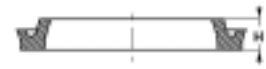
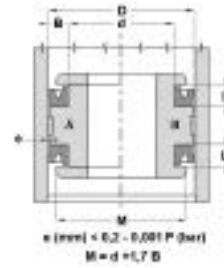

Toleranz / Tolerance		
D	d	L
H9 / e8	h9	+0,50 0

**Note:** Dimensions, see under chapter Hydraulics / Piston seals

**Ordering information:** We are able to produce seals with diameters of 20 to 510 mm with short lead times.

**Web:** <http://cat.hansa-flex.com/en/DDEDITKOLBENPNEU>

2

## DDEM

## Piston seal DDEM

Low-friction seal. Simple solution.

**Design:** Piston U-ring  
**Operating pressure:** up to 80 bar  
**Sliding speed max.:** 0,5 m/s  
**Design:** Metric  
**Temp. min.:** -30 °C  
**Temp. max.:** 100 °C  
**Media:** Mineral oils, Water-air  
**Installation:** on one-piece pistons A, on multi-part pistons B  
**Material:** NBR 75° Shore A  
**Application:** Hydraulics + pneumatics

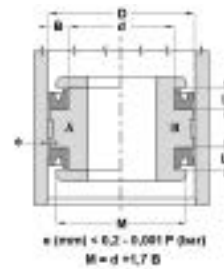

Toleranz / Tolerance		
D	d	L
H9 / e8	h9	+0,50 0

**Note:** Dimensions, see under chapter Hydraulics / Piston seals

**Ordering information:** We are able to produce seals with diameters of 20 to 510 mm with short lead times.

**Web:** <http://cat.hansa-flex.com/en/DDEMDITKOLBENPNEU>

## DDEM P

## Piston seal, DDEM-P

Low-friction seal. Simple solution.

**Design:** Piston U-ring  
**Operating pressure:** up to 16 bar  
**Sliding speed max.:** 1,0 m/s  
**Design:** Metric  
**Temp. min.:** -30 °C  
**Temp. max.:** 80 °C  
**Media:** Air  
**Installation:** on one-piece pistons A, on multi-part pistons B  
**Material:** PUR 90° Shore A  
**Application:** Hydraulics + pneumatics

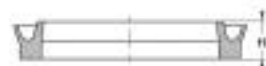
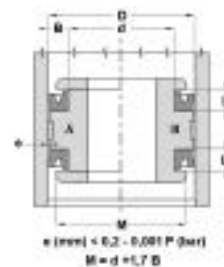

Toleranz / Tolerance		
D	d	L
H9 / e8	h9	+0,50 0

**Note:** Dimensions, see under chapter Hydraulics / Piston seals

**Ordering information:** We are able to produce seals with diameters of 20 to 510 mm with short lead times.

**Web:** <http://cat.hansa-flex.com/en/DDEMPDITKOLBENPNEU>

**DUM**

**U-ring DUM**

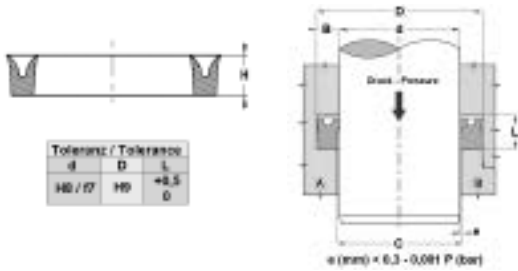

Low-friction seal. Simple solution. For rods and pistons.

- Design:** U-ring
- Operating pressure:** up to 120 bar
- Sliding speed max.:** 0,5 m/s
- Design:** Metric
- Temp. min.:** -30 °C
- Temp. max.:** 100 °C
- Media:** Mineral oils, Water-air
- Installation:** on one-piece pistons A, on multi-part pistons B
- Material:** Seal: NBR 90° Shore A
- Application:** Hydraulics + pneumatics

**Note:** Dimensions see page Rod seals ...

**Ordering information:** We are able to produce seals with diameters of 20 to 510 mm with short lead times.

**Web:** <http://cat.hansa-flex.com/en/DUMDITKOLBENPNEU>

**GPP**

**GPP**

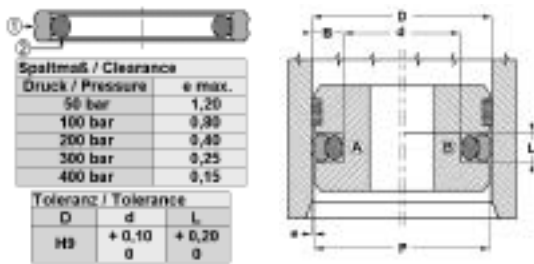

Easy assembly. Low spatial requirement. Extremely good sealing effect. High abrasion resistance.

- Operating pressure:** up to 16 bar
- Sliding speed max.:** 1,0 m/s
- Temp. min.:** -30 °C
- Temp. max.:** 80 °C
- Media:** Mineral oils
- Installation:** on one-piece pistons A, on multi-part pistons B
- Material:** (1) Dynamic seal: PUR, (2) Static seal: NBR
- Application:** Pneumatics

Identification	D mm	d mm	L mm
GPP 16	16	9	2,5
GPP 25	25	18	2,5
GPP 63	63	51	4,0

**Web:** <http://cat.hansa-flex.com/en/GPP>

**TDOP**

**Complete piston TDOP**

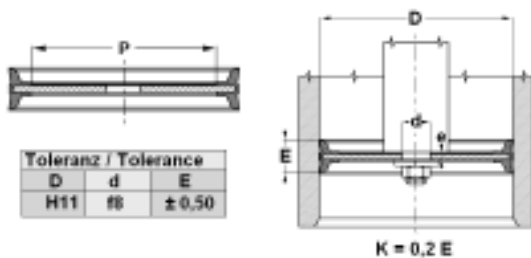

Complete pistons.

- Design:** Complete pistons
- Operating pressure:** up to 10 bar
- Sliding speed max.:** 1,0 m/s
- Temp. min.:** -30 °C
- Temp. max.:** 110 °C
- Media:** Mineral oils, Water-air
- Installation:** push onto piston recess with the rubber side and affix with washer and nut.
- Material:** NBR 85° Shore A, with steel core
- Application:** Pneumatics

**Note:** Tolerance: D= H11; d= f8; E= +/-0,5

**Ordering information:** For special operating conditions (fluid, temperature, pressure ...) please contact us. Alternative material possible: FPM, EPDM.

Identification	D mm	d mm	P mm	E mm	e mm
TDOP 25	25	8	15,6	12	3,8
TDOP 32	32	8	20,0	15	3,8
TDOP 40	40	10	27,0	18	4,8
TDOP 50	50	10	37,0	18	4,8



(Continued)

TDOP

## Complete piston TDOP

Identification	D mm	d mm	P mm	E mm	e mm
TDOP 60	60	12	43,0	22	6,0
TDOP 63	63	12	43,0	22	6,0
TDOP 063-1	63	16	43,0	22	6,0
TDOP 65	65	12	43,0	25	6,0
TDOP 70	70	12	50,0	25	6,0
TDOP 80	80	16	55,0	24	6,0
TDOP 100	100	20	75,0	26	7,0
TDOP 125	125	20	95,0	26	9,6
TDOP 160	160	27	129,0	30	10,8
TDOP 200	200	27	169,0	35	11,4

**Web:** <http://cat.hansa-flex.com/en/TDOP>



## Seal kits and measuring equipment

**Seal kits**

Packing sets for single-acting HF cylinders	146
Packing sets for double-acting HF (high-flow) cylinders	147
Packing sets for guide heads wide	148

**measuring equipment**

measuring equipment	149
Installation Tools	150

## HK GKG T

### Packing set HKGKGT



**Design:** complete packing set for HANSA-FLEX standard cylinders  
 for single-acting cylinders  
**Construction type:** for plunger rods

Identification	Ø S mm	Weight kg
HK GKG T 020 030	20	0,29
HK GKG T 025 035	25	0,33
HK GKG T 030 040	30	0,20
HK GKG T 035 045	35	0,44
HK GKG T 040 050	40	0,20
HK GKG T 045 055	45	0,59

Ø S = piston rod diameter

Identification	Ø S mm	Weight kg
HK GKG T 050 060	50	0,20
HK GKG T 060 070	60	0,75
HK GKG T 070 000	70	0,75
HK GKG T 080 000	80	1,98
HK GKG T 100 000	100	2,10

Ø S = piston rod diameter

**Web:** <http://cat.hansa-flex.com/en/HKGKGT>

## HK KIT

### Packing set HKKIT



**Design:** Packing set for cylinder HKHFRT

Identification	Ø S mm	Weight kg
HK KIT HFRT 125	25	0,2
HK KIT HFRT 230	30	0,2
HK KIT HFRT 340	40	0,2

Ø S = piston rod diameter

**Web:** <http://cat.hansa-flex.com/en/HKKIT>

## HK GKG

## Packing set HKGKG

**Design:** complete packing set for HANSA-FLEX standard cylinders  
**Design:** for double-acting cylinders



Identification	Ø A mm	Ø S mm	Weight kg
HK GKG 0030 016	30	16	0,20
HK GKG 0032 020	32	20	0,20
HK GKG 0035 020	35	20	0,20
HK GKG 0035 022	35	22	0,20
HK GKG 0040 020	40	20	0,20
HK GKG 0040 022	40	22	0,20
HK GKG 0040 025	40	25	0,20
HK GKG 0045 022	45	22	0,20
HK GKG 0045 025	45	25	0,20
HK GKG 0050 020	50	20	0,20
HK GKG 0050 025	50	25	0,25
HK GKG 0050 030	50	30	0,25
HK GKG 0050 035	50	35	0,20
HK GKG 0055 025	55	25	0,20
HK GKG 0055 030	55	30	0,20
HK GKG 0055 035	55	35	0,20
HK GKG 0060 025	60	25	0,20
HK GKG 0060 030	60	30	0,25
HK GKG 0060 035	60	35	0,25
HK GKG 0060 040	60	40	0,30
HK GKG 0063 030	63	30	0,20
HK GKG 0063 035	63	35	0,20
HK GKG 0063 040	63	40	0,20
HK GKG 0065 030	65	30	0,20
HK GKG 0065 035	65	35	0,20
HK GKG 0065 040	65	40	0,20
HK GKG 0065 045	65	45	0,20
HK GKG 0070 025	70	25	0,20
HK GKG 0070 030	70	30	0,20
HK GKG 0070 035	70	35	0,30
HK GKG 0070 040	70	40	0,30
HK GKG 0070 045	70	45	0,20
HK GKG 0070 050	70	50	0,20
HK GKG 0075 030	75	30	0,20
HK GKG 0075 035	75	35	0,20
HK GKG 0075 040	75	40	0,20

Ø A = piston diameter    Ø S = piston rod diameter

Identification	Ø A mm	Ø S mm	Weight kg
HK GKG 0075 045	75	45	0,20
HK GKG 0080 030	80	30	0,20
HK GKG 0080 035	80	35	0,20
HK GKG 0080 040	80	40	0,30
HK GKG 0080 045	80	45	0,20
HK GKG 0080 050	80	50	0,40
HK GKG 0080 055	80	55	0,20
HK GKG 0080 060	80	60	0,20
HK GKG 0085 035	85	35	0,20
HK GKG 0085 040	85	40	0,20
HK GKG 0085 050	85	50	0,20
HK GKG 0090 040	90	40	0,20
HK GKG 0090 045	90	45	0,20
HK GKG 0090 050	90	50	0,20
HK GKG 0090 060	90	60	0,20
HK GKG 0100 040	100	40	0,20
HK GKG 0100 045	100	45	0,20
HK GKG 0100 050	100	50	0,40
HK GKG 0100 055	100	55	0,20
HK GKG 0100 060	100	60	0,40
HK GKG 0100 070	100	70	0,20
HK GKG 0110 045	110	45	0,20
HK GKG 0110 050	110	50	0,20
HK GKG 0110 060	110	60	0,20
HK GKG 0110 070	110	70	0,20
HK GKG 0120 050	120	50	0,20
HK GKG 0120 060	120	60	0,20
HK GKG 0120 070	120	70	0,20
HK GKG 0125 060	125	60	0,20
HK GKG 0125 070	125	70	0,20
HK GKG 0140 070	140	70	0,20
HK GKG 0140 080	140	80	0,20
HK GKG 0150 070	150	70	0,20
HK GKG 0150 080	150	80	0,20
HK GKG 0160 080	160	80	0,20
HK GKG 0160 090	160	90	0,20

Ø A = piston diameter    Ø S = piston rod diameter

**Web:** <http://cat.hansa-flex.com/en/HKGKG>

## HK GKG 2S

## Packing set HKGKG2S



Identification	Ø A mm	Ø S mm
HK GKG 2S 0040 025	40	25
HK GKG 2S 0050 030	50	30
HK GKG 2S 0060 030	60	30
HK GKG 2S 0060 035	60	35

Ø A = piston diameter    Ø S = piston rod diameter

Identification	Ø A mm	Ø S mm
HK GKG 2S 0070 040	70	40
HK GKG 2S 0080 040	80	40
HK GKG 2S 0100 050	100	50

Ø A = piston diameter    Ø S = piston rod diameter

**Web:** <http://cat.hansa-flex.com/en/HKGKG2S>

## HK DSF

### Packing set for hydraulic cylinder DSF



**Design:** Packing set for guide head

Identification	for guide yoke	Weight kg
HK DSF 32 16		0,2
HK DSF 40 28		0,2
HK DSF 40 30		0,2
HK DSF 45 20		0,2
HK DSF 45 30		0,2
HK DSF 50 28		0,2

Identification	for guide yoke	Weight kg
HK DSF 63 25		0,2
HK DSF 6336		0,3
HK DSF 63 45		0,2
HK DSF 125 80		0,3
HK DSF 140 100		0,3
HK DSF 150 100		0,3

**Web:** <http://cat.hansa-flex.com/en/HKDSF>

**MK**
**Measuring cone for O-rings**

With the measuring cone set MKS5-284, all popular O rings within the diameter range of 5 - 285 mm can be measured. In order to comply with the demands made on a measuring device an especially tough high-quality material was used for its manufacture. The measuring cone set is comprised of seven individual segments which can be inserted into each other for storing or transportation. When set up, a measuring tower of maximum 1.64 m is formed.

**Design:** Measuring cone for O-rings

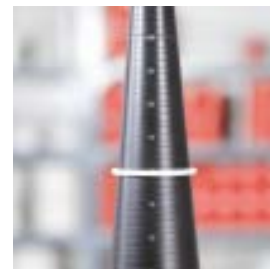

Identification	Measuring range
MKS 5-284	5 - 284 mm
MK 5-44	5 - 44 mm
MK 45-84	45 - 84 mm
K-DMK 85-124	
K-DMK 125-164	

**Web:** <http://cat.hansa-flex.com/en/MK>

**MT**
**Measuring equipment for seal identification**

The internal measuring probe is used for determining the exact diameter of grooves in the inside of seal housings, pipes and guides etc.

**Design:** Internal measuring probe



Identification	Measuring range
MT 150	150 mm
MT 200	200 mm
MT 300	300 mm

**Web:** <http://cat.hansa-flex.com/en/MT>

**UNI-MESSSCHIEBER**
**Universal Vernier callipers**

For an exact description of seals, information is generally required on the metallic installation space. The required measuring instruments are normally only suitable for one application. This vernier caliper gauge, on the other hand, can be universally used for measurements on seal housings, pistons and rods. It can determine the exact depth and width of inside and outside grooves. It is thus an ideal measuring tool for repair and maintenance workshops.

**Design:** Monitor with three display possibilities

**Measurable dimensions:** Inside and outside diameter, groove depth, groove width



Identification	Measuring range	Inside measurement	Groove width inside	Groove depth inside
UNI-MESSSCHIEBER	0 - 200 mm / 0 - 8"	above 20 mm	above 3 mm	up to 20 mm / 3/4"

**Web:** <http://cat.hansa-flex.com/en/UNIMESSSCHIEBER>

## DEMONTAGE-SET

### Disassembly SET



Set of disassembly tools for O-rings and U-rings, 8 pcs., in plastic box.

**Application:** The disassembly tool set can be used for almost every range of O-rings and U-rings.

#### Identification

DEMONTAGE SET

**Web:** <http://cat.hansa-flex.com/en/DEMONTAGESET>

3

## DICHTUNGS PICK SET

### Seal pick Set



**Design:** Seal fitting set

**Included in scope of supply:** 5 tools

**Material:** Stainless steel

#### Identification

DICHTUNGS PICK SET

**Web:** <http://cat.hansa-flex.com/en/DICHTUNGSPICKSET>

## DICHTUNGS ZANGE

### Seal pliers



For fitting rod seals in the seal housing.

**Design:** Assembly pliers for seals

**Material:** Steel

#### Identification

DICHTUNGSZANGE

**Web:** <http://cat.hansa-flex.com/en/DICHTUNGSZANGE>



**O-RING PICK SET**

## O-ring pick set

**Design:** Fitting set for O-ring  
**Included in scope of supply:** 5 tools  
**Material:** Stainless steel

**Identification**

O-RINGPICKSET

**Web:** <http://cat.hansa-flex.com/en/ORINGPICKSET>



## Static seals

<b>O-rings</b>	
NBR O-rings	154
Viton O-rings	175
EPDM O-rings	181
Silicone O-rings	181
O-ring cord	182
O-ring assortments	183
<b>Quad rings</b>	
NBR quad rings	186
<b>Support rings</b>	
NBR support rings	187
PTFE support rings	189
Polyester support ring	191
<b>Usit rings</b>	
NBR/steel Usit ring	195
<b>Flange seals</b>	
PUR SAE flange seal	198

**OR 70° Shore NBR**

**O-ring, 70SH NBR**

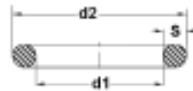

**Design:** O-ring  
**Temp. min.:** -30 °C  
**Temp. max.:** 100 °C  
**Material:** NBR 70 Shore A

Identification	d1 mm	d2 mm	s mm	Packaging unit
OR 1.15-1	1,15	3,15	1,00	-*
OR 1.24-2.62	1,24	6,48	2,62	-*
OR 1.5-1	1,50	3,50	1,00	-*
OR 1.5-1.5	1,50	4,50	1,50	100 piece
OR 1.78-1.02	1,78	3,82	1,02	100 piece
OR 1.78-1.78	1,78	5,34	1,78	-*
OR 1.8-1	1,80	3,80	1,00	-*
OR 1.8-1.2	1,80	4,20	1,20	100 piece
OR 1.85-1.5	1,85	4,85	1,50	-*
OR 2-0.5	2,00	3,00	0,50	100 piece
OR 2-1	2,00	4,00	1,00	-*
OR 2-1.5	2,00	5,00	1,50	100 piece
OR 2-2	2,00	6,00	2,00	100 piece
OR 2.06-2.62	2,06	7,30	2,62	-*
OR 2.2-1	2,20	4,20	1,00	-*
OR 2.4-1.9	2,40	6,20	1,90	100 piece
OR 2.5-1	2,50	4,50	1,00	-*
OR 2.5-1.5	2,50	5,50	1,50	-*
OR 2.5-2	2,50	6,50	2,00	-*
OR 2.57-1.78	2,57	6,13	1,78	-*
OR 2.6-1.2	2,60	5,00	1,20	100 piece
OR 2.6-1.8	2,60	6,20	1,80	100 piece
OR 2.6-1.9	2,60	6,40	1,90	100 piece
OR 2.8-1.5	2,80	5,80	1,50	-*
OR 2.84-2.62	2,84	8,08	2,62	-*
OR 2.9-1.78	2,90	6,46	1,78	100 piece
OR 3-1	3,00	5,00	1,00	100 piece
OR 3-1.5	3,00	6,00	1,50	100 piece
OR 3-1.8	3,00	6,60	1,80	-*
OR 3-2	3,00	7,00	2,00	100 piece
OR 3-2.4	3,00	7,80	2,40	100 piece
OR 3-2.5	3,00	8,00	2,50	-*
OR 3-2.7	3,00	8,40	2,70	-*
OR 3.17-1.78	3,17	6,73	1,78	-*
OR 3.2-2.5	3,20	8,20	2,50	100 piece
OR 3.3-2.4	3,30	8,10	2,40	100 piece
OR 3.4-1.9	3,40	7,20	1,90	100 piece
OR 3.5-1	3,50	5,50	1,00	-*
OR 3.5-1.5	3,50	6,50	1,50	100 piece
OR 3.5-2	3,50	7,50	2,00	-*
OR 3.6-2.4	3,60	8,40	2,40	100 piece
OR 3.63-2.62	3,63	8,87	2,62	-*
OR 3.68-1.78	3,68	7,24	1,78	-*
OR 3.7-1	3,70	5,70	1,00	100 piece
OR 3.8-1.5	3,80	6,80	1,50	100 piece
OR 4-1	4,00	6,00	1,00	100 piece
OR 4-1.5	4,00	7,00	1,50	100 piece
OR 4-1.75	4,00	7,50	1,75	100 piece
OR 4-1.85	4,00	7,70	1,85	100 piece
OR 4-2	4,00	8,00	2,00	100 piece
OR 4-2.2	4,00	8,40	2,20	100 piece
OR 4-2.5	4,00	9,00	2,50	100 piece
OR 4-3	4,00	10,00	3,00	100 piece
OR 4.2-1.9	4,20	8,00	1,90	100 piece
OR 4.3-2.4	4,30	9,10	2,40	100 piece
OR 4.34-3.53	4,34	11,40	3,53	-*
OR 4.42-2.62	4,42	9,66	2,62	-*
OR 4.47-1.78	4,47	8,03	1,78	-*
OR 4.48-1.78	4,48	8,04	1,78	100 piece
OR 4.5-1	4,50	6,50	1,00	100 piece
OR 4.5-1.5	4,50	7,50	1,50	100 piece
OR 4.5-1.7	4,50	7,90	1,70	-*
OR 4.5-2	4,50	8,50	2,00	100 piece
OR 4.5-2.5	4,50	9,50	2,50	100 piece
OR 4.76-1.78	4,76	8,32	1,78	-*
OR 4.8-1.8	4,80	8,40	1,80	100 piece
OR 4.9-1.9	4,90	8,70	1,90	100 piece
OR 5-1	5,00	7,00	1,00	100 piece
OR 5-1.2	5,00	7,40	1,20	100 piece
OR 5-1.5	5,00	8,00	1,50	100 piece
OR 5-2	5,00	9,00	2,00	100 piece
OR 5-2.5	5,00	10,00	2,50	100 piece
OR 5-3	5,00	11,00	3,00	100 piece
OR 5.1-1.6	5,10	8,30	1,60	-*
OR 5.23-2.62	5,23	10,47	2,62	-*

Packaging unit: -\* upon request

Identification	d1 mm	d2 mm	s mm	Packaging unit
OR 5.28-1.78	5,28	8,84	1,78	100 piece
OR 5.3-2.4	5,30	10,10	2,40	100 piece
OR 5.3-2.5	5,30	10,30	2,50	100 piece
OR 5.5-1	5,50	7,50	1,00	100 piece
OR 5.5-1.5	5,50	8,50	1,50	100 piece
OR 5.5-2	5,50	9,50	2,00	100 piece
OR 5.5-2.5	5,50	10,50	2,50	-*
OR 5.5-3	5,50	11,50	3,00	-*
OR 5.6-2.4	5,60	10,40	2,40	100 piece
OR 5.7-1.9	5,70	9,50	1,90	100 piece
OR 5.8-1.5	5,80	8,80	1,50	-*
OR 5.94-3.53	5,94	13,00	3,53	100 piece
OR 6-1	6,00	8,00	1,00	100 piece
OR 6-1.5	6,00	9,00	1,50	100 piece
OR 6-1.6	6,00	9,20	1,60	100 piece
OR 6-1.8	6,00	9,60	1,80	100 piece
OR 6-2	6,00	10,00	2,00	100 piece
OR 6-2.5	6,00	11,00	2,50	100 piece
OR 6-3	6,00	12,00	3,00	100 piece
OR 6-3.5	6,00	13,00	3,50	100 piece
OR 6-6	6,00	18,00	6,00	-*
OR 6.02-2.62	6,02	11,26	2,62	-*
OR 6.07-1.63	6,07	9,33	1,63	100 piece
OR 6.07-1.78	6,07	9,63	1,78	100 piece
OR 6.1-1.6	6,10	9,30	1,60	-*
OR 6.3-2.4	6,30	11,10	2,40	-*
OR 6.35-1.78	6,35	9,91	1,78	-*
OR 6.4-1.9	6,40	10,20	1,90	-*
OR 6.5-1	6,50	8,50	1,00	-*
OR 6.5-1.5	6,50	9,50	1,50	100 piece
OR 6.5-2	6,50	10,50	2,00	-*
OR 6.5-2.5	6,50	11,50	2,50	-*
OR 6.5-3	6,50	12,50	3,00	-*
OR 6.75-1.78	6,75	10,31	1,78	100 piece
OR 7-1	7,00	9,00	1,00	-*
OR 7-1.5	7,00	10,00	1,50	100 piece
OR 7-1.8	7,00	10,60	1,80	-*
OR 7-2	7,00	11,00	2,00	100 piece
OR 7-2.5	7,00	12,00	2,50	100 piece
OR 7-3	7,00	13,00	3,00	100 piece
OR 7-4	7,00	15,00	4,00	100 piece
OR 7-6	7,00	19,00	6,00	-*
OR 7.1-1.6	7,10	10,30	1,60	100 piece
OR 7.2-1.9	7,20	11,00	1,90	100 piece
OR 7.3-2.4	7,30	12,10	2,40	100 piece
OR 7.5-1	7,50	9,50	1,00	-*
OR 7.5-1.5	7,50	10,50	1,50	100 piece
OR 7.5-2	7,50	11,50	2,00	100 piece
OR 7.5-2.4	7,50	12,30	2,40	-*
OR 7.5-2.5	7,50	12,50	2,50	-*
OR 7.5-3	7,50	13,50	3,00	-*
OR 7.52-3.53	7,52	14,58	3,53	100 piece
OR 7.59-2.62	7,59	12,83	2,62	-*
OR 7.66-1.78	7,66	11,22	1,78	-*
OR 7.94-1.78	7,94	11,50	1,78	-*
OR 8-1	8,00	10,00	1,00	-*
OR 8-1.5	8,00	11,00	1,50	100 piece
OR 8-1.6	8,00	11,20	1,60	100 piece
OR 8-1.7	8,00	11,40	1,70	100 piece
OR 8-2	8,00	12,00	2,00	100 piece
OR 8-2.2	8,00	12,40	2,20	100 piece
OR 8-2.4	8,00	12,80	2,40	-*
OR 8-2.5	8,00	13,00	2,50	100 piece
OR 8-3	8,00	14,00	3,00	100 piece
OR 8-3.5	8,00	15,00	3,50	100 piece
OR 8-4	8,00	16,00	4,00	100 piece
OR 8.1-1.6	8,10	11,30	1,60	100 piece
OR 8.3-2.4	8,30	13,10	2,40	100 piece
OR 8.5-1	8,50	10,50	1,00	-*
OR 8.5-1.5	8,50	11,50	1,50	-*
OR 8.5-2	8,50	12,50	2,00	100 piece
OR 8.5-2.5	8,50	13,50	2,50	-*
OR 8.5-3	8,50	14,50	3,00	100 piece
OR 8.73-1.78	8,73	12,29	1,78	100 piece
OR 8.9-1.9	8,90	12,70	1,90	100 piece

Packaging unit: -\* upon request



(Continued)

OR 70° Shore NBR

O-ring, 70SH NBR

Identification	d1	d2	s	Packaging unit	Identification	d1	d2	s	Packaging unit
	mm	mm	mm			mm	mm	mm	
OR 8.9-2.7	8,90	14,30	2,70	.*	OR 12.42-1.78	12,42	15,98	1,78	100 piece
OR 8.92-1.83	8,92	12,58	1,83	100 piece	OR 12.5-1	12,50	14,50	1,00	100 piece
OR 9-1	9,00	11,00	1,00	100 piece	OR 12.5-1.5	12,50	15,50	1,50	.*
OR 9-1.5	9,00	12,00	1,50	100 piece	OR 12.5-2	12,50	16,50	2,00	.*
OR 9-2	9,00	13,00	2,00	100 piece	OR 12.5-2.5	12,50	17,50	2,50	100 piece
OR 9-2.5	9,00	14,00	2,50	100 piece	OR 12.5-3	12,50	18,50	3,00	.*
OR 9-2.62	9,00	14,24	2,62	100 piece	OR 12.6-2.4	12,60	17,40	2,40	.*
OR 9-3	9,00	15,00	3,00	100 piece	OR 12.7-2.62	12,70	17,94	2,62	.*
OR 9-3.5	9,00	16,00	3,50	100 piece	OR 12.8-2.4	12,80	17,60	2,40	100 piece
OR 9-6	9,00	21,00	6,00	.*	OR 13-1	13,00	15,00	1,00	100 piece
OR 9.1-1.6	9,10	12,30	1,60	.*	OR 13-1.5	13,00	16,00	1,50	100 piece
OR 9.12-3.53	9,12	16,18	3,53	100 piece	OR 13-1.7	13,00	16,40	1,70	100 piece
OR 9.13-2.62	9,13	14,37	2,62	.*	OR 13-2	13,00	17,00	2,00	100 piece
OR 9.19-2.62	9,19	14,43	2,62	100 piece	OR 13-2.5	13,00	18,00	2,50	100 piece
OR 9.25-1.78	9,25	12,81	1,78	100 piece	OR 13-3	13,00	19,00	3,00	100 piece
OR 9.3-2.4	9,30	14,10	2,40	100 piece	OR 13-3.5	13,00	20,00	3,50	100 piece
OR 9.5-1	9,50	11,50	1,00	100 piece	OR 13-4	13,00	21,00	4,00	100 piece
OR 9.5-1.5	9,50	12,50	1,50	100 piece	OR 13-5	13,00	23,00	5,00	100 piece
OR 9.5-2	9,50	13,50	2,00	100 piece	OR 13-6	13,00	25,00	6,00	.*
OR 9.5-2.5	9,50	14,50	2,50	.*	OR 13.1-1.6	13,10	16,30	1,60	.*
OR 9.5-3	9,50	15,50	3,00	.*	OR 13.1-2.62	13,10	18,34	2,62	.*
OR 9.52-1.78	9,52	13,08	1,78	.*	OR 13.3-2.4	13,30	18,10	2,40	100 piece
OR 9.6-2.4	9,60	14,40	2,40	.*	OR 13.5-1	13,50	15,50	1,00	.*
OR 9.9-2.62	9,90	15,14	2,62	.*	OR 13.5-1.5	13,50	16,50	1,50	.*
OR 10-1	10,00	12,00	1,00	100 piece	OR 13.5-2	13,50	17,50	2,00	.*
OR 10-1.5	10,00	13,00	1,50	100 piece	OR 13.5-2.5	13,50	18,50	2,50	.*
OR 10-1.8	10,00	13,60	1,80	100 piece	OR 13.5-3	13,50	19,50	3,00	.*
OR 10-2	10,00	14,00	2,00	100 piece	OR 13.64-5.34	13,64	24,32	5,34	.*
OR 10-2.2	10,00	14,40	2,20	100 piece	OR 13.87-3.53	13,87	20,93	3,53	.*
OR 10-2.4	10,00	14,80	2,40	100 piece	OR 13.94-2.62	13,94	19,18	2,62	.*
OR 10-2.5	10,00	15,00	2,50	100 piece	OR 13.95-2.62	13,95	19,19	2,62	100 piece
OR 10-3	10,00	16,00	3,00	100 piece	OR 14-1	14,00	16,00	1,00	100 piece
OR 10-3.5	10,00	17,00	3,50	100 piece	OR 14-1.5	14,00	17,00	1,50	100 piece
OR 10-4	10,00	18,00	4,00	.*	OR 14-1.6	14,00	17,20	1,60	.*
OR 10-5	10,00	20,00	5,00	100 piece	OR 14-1.78	14,00	17,56	1,78	100 piece
OR 10-6	10,00	22,00	6,00	.*	OR 14-2	14,00	18,00	2,00	100 piece
OR 10.1-1.6	10,10	13,30	1,60	.*	OR 14-2.3	14,00	18,60	2,30	.*
OR 10.3-2.4	10,30	15,10	2,40	100 piece	OR 14-2.5	14,00	19,00	2,50	100 piece
OR 10.5-1	10,50	12,50	1,00	.*	OR 14-3	14,00	20,00	3,00	100 piece
OR 10.5-1.5	10,50	13,50	1,50	100 piece	OR 14-3.5	14,00	21,00	3,50	.*
OR 10.5-2	10,50	14,50	2,00	.*	OR 14-4	14,00	22,00	4,00	100 piece
OR 10.5-2.5	10,50	15,50	2,50	.*	OR 14-5	14,00	24,00	5,00	.*
OR 10.5-3	10,50	16,50	3,00	.*	OR 14-6	14,00	26,00	6,00	.*
OR 10.69-3.53	10,69	17,75	3,53	100 piece	OR 14.1-1.6	14,10	17,30	1,60	.*
OR 10.78-2.62	10,78	16,02	2,62	.*	OR 14.3-2.4	14,30	19,10	2,40	100 piece
OR 10.8-1.8	10,80	14,40	1,80	100 piece	OR 14.4-2	14,40	18,40	2,00	100 piece
OR 10.82-1.78	10,82	14,38	1,78	100 piece	OR 14.5-1	14,50	16,50	1,00	.*
OR 11-1	11,00	13,00	1,00	100 piece	OR 14.5-1.5	14,50	17,50	1,50	.*
OR 11-1.2	11,00	13,40	1,20	100 piece	OR 14.5-2	14,50	18,50	2,00	.*
OR 11-1.5	11,00	14,00	1,50	100 piece	OR 14.5-2.5	14,50	19,50	2,50	.*
OR 11-1.8	11,00	14,60	1,80	100 piece	OR 14.5-3	14,50	20,50	3,00	.*
OR 11-2	11,00	15,00	2,00	100 piece	OR 15-1	15,00	17,00	1,00	100 piece
OR 11-2.5	11,00	16,00	2,50	100 piece	OR 15-1.5	15,00	18,00	1,50	100 piece
OR 11-2.75	11,00	16,50	2,75	100 piece	OR 15-2	15,00	19,00	2,00	100 piece
OR 11-3	11,00	17,00	3,00	100 piece	OR 15-2.5	15,00	20,00	2,50	100 piece
OR 11-3.5	11,00	18,00	3,50	100 piece	OR 15-2.6	15,00	20,20	2,60	100 piece
OR 11-4	11,00	19,00	4,00	.*	OR 15-3	15,00	21,00	3,00	100 piece
OR 11-6	11,00	23,00	6,00	.*	OR 15-3.2	15,00	21,40	3,20	100 piece
OR 11.1-1.6	11,10	14,30	1,60	.*	OR 15-3.5	15,00	22,00	3,50	100 piece
OR 11.11-1.78	11,11	14,67	1,78	.*	OR 15-4	15,00	23,00	4,00	100 piece
OR 11.3-2.4	11,30	16,10	2,40	100 piece	OR 15-4.5	15,00	24,00	4,50	.*
OR 11.5-1	11,50	13,50	1,00	.*	OR 15-5	15,00	25,00	5,00	100 piece
OR 11.5-1.5	11,50	14,50	1,50	.*	OR 15-5.6	15,00	26,20	5,60	.*
OR 11.5-2	11,50	15,50	2,00	100 piece	OR 15-6	15,00	27,00	6,00	.*
OR 11.5-2.5	11,50	16,50	2,50	.*	OR 15.08-2.62	15,08	20,32	2,62	100 piece
OR 11.5-3	11,50	17,50	3,00	.*	OR 15.1-1.6	15,10	18,30	1,60	.*
OR 11.89-1.98	11,89	15,85	1,98	100 piece	OR 15.1-2.7	15,10	20,50	2,70	100 piece
OR 11.91-2.62	11,91	17,15	2,62	.*	OR 15.24-5.34	15,24	25,92	5,34	.*
OR 12-1	12,00	14,00	1,00	100 piece	OR 15.3-1.78	15,30	18,86	1,78	100 piece
OR 12-1.5	12,00	15,00	1,50	100 piece	OR 15.3-2.4	15,30	20,10	2,40	100 piece
OR 12-1.7	12,00	15,40	1,70	100 piece	OR 15.47-3.53	15,47	22,53	3,53	100 piece
OR 12-1.9	12,00	15,80	1,90	100 piece	OR 15.5-1	15,50	17,50	1,00	.*
OR 12-2	12,00	16,00	2,00	100 piece	OR 15.5-1.5	15,50	18,50	1,50	.*
OR 12-2.5	12,00	17,00	2,50	100 piece	OR 15.5-2	15,50	19,50	2,00	.*
OR 12-3	12,00	18,00	3,00	100 piece	OR 15.5-2.5	15,50	20,50	2,50	.*
OR 12-3.2	12,00	18,40	3,20	.*	OR 15.5-3	15,50	21,50	3,00	.*
OR 12-3.5	12,00	19,00	3,50	100 piece	OR 15.54-2.62	15,54	20,78	2,62	100 piece
OR 12-4	12,00	20,00	4,00	100 piece	OR 15.6-1.78	15,60	19,16	1,78	100 piece
OR 12-4.5	12,00	21,00	4,50	100 piece	OR 15.88-2.62	15,88	21,12	2,62	100 piece
OR 12-5	12,00	22,00	5,00	100 piece	OR 16-1	16,00	18,00	1,00	100 piece
OR 12-6	12,00	24,00	6,00	.*	OR 16-1.5	16,00	19,00	1,50	100 piece
OR 12-7	12,00	26,00	7,00	.*	OR 16-2	16,00	20,00	2,00	100 piece
OR 12.07-5.34	12,07	22,75	5,34	.*	OR 16-2.5	16,00	21,00	2,50	100 piece
OR 12.1-1.6	12,10	15,30	1,60	100 piece	OR 16-3	16,00	22,00	3,00	100 piece
OR 12.1-2.7	12,10	17,50	2,70	100 piece	OR 16-3.5	16,00	23,00	3,50	100 piece
OR 12.29-3.53	12,29	19,35	3,53	100 piece	OR 16-4	16,00	24,00	4,00	.*
OR 12.3-2.4	12,30	17,10	2,40	100 piece	OR 16-4.5	16,00	25,00	4,50	100 piece
OR 12.37-2.62	12,37	17,61	2,62	100 piece	OR 16-5	16,00	26,00	5,00	.*

Packaging unit: .\* upon request

Packaging unit: .\* upon request

Web: <http://cat.hansa-flex.com/en/OR70SHORENBR>

**OR 70° Shore NBR**

(Continued)

**O-ring, 70SH NBR**

Identification	d1 mm	d2 mm	s mm	Packaging unit
OR 16-6	16,00	28,00	6,00	-*
OR 16.1-1.6	16,10	19,30	1,60	-*
OR 16.3-2.4	16,30	21,10	2,40	100 piece
OR 16.36-2.21	16,36	20,78	2,21	100 piece
OR 16.5-1	16,50	18,50	1,00	-*
OR 16.5-1.5	16,50	19,50	1,50	-*
OR 16.5-2	16,50	20,50	2,00	100 piece
OR 16.5-2.5	16,50	21,50	2,50	-*
OR 16.5-3	16,50	22,50	3,00	100 piece
OR 16.81-5.34	16,81	27,49	5,34	-*
OR 16.9-2.7	16,90	22,30	2,70	100 piece
OR 17-1	17,00	19,00	1,00	100 piece
OR 17-1.5	17,00	20,00	1,50	100 piece
OR 17-1.78	17,00	20,56	1,78	-*
OR 17-2	17,00	21,00	2,00	100 piece
OR 17-2.5	17,00	22,00	2,50	100 piece
OR 17-2.7	17,00	22,40	2,70	100 piece
OR 17-3	17,00	23,00	3,00	100 piece
OR 17-3.5	17,00	24,00	3,50	100 piece
OR 17-4	17,00	25,00	4,00	100 piece
OR 17-4.5	17,00	26,00	4,50	-*
OR 17-5	17,00	27,00	5,00	-*
OR 17.04-3.53	17,04	24,10	3,53	-*
OR 17.1-1.6	17,10	20,30	1,60	-*
OR 17.13-2.62	17,13	22,37	2,62	100 piece
OR 17.16-1.78	17,16	20,72	1,78	100 piece
OR 17.3-2.4	17,30	22,10	2,40	100 piece
OR 17.46-2.62	17,46	22,70	2,62	-*
OR 17.5-1	17,50	19,50	1,00	-*
OR 17.5-1.5	17,50	20,50	1,50	-*
OR 17.5-2	17,50	21,50	2,00	100 piece
OR 17.5-2.5	17,50	22,50	2,50	100 piece
OR 17.5-3	17,50	23,50	3,00	-*
OR 17.5-3.5	17,50	24,50	3,50	100 piece
OR 17.74-1.78	17,74	21,30	1,78	100 piece
OR 17.86-2.62	17,86	23,10	2,62	100 piece
OR 18-1	18,00	20,00	1,00	100 piece
OR 18-1.5	18,00	21,00	1,50	-*
OR 18-2	18,00	22,00	2,00	100 piece
OR 18-2.5	18,00	23,00	2,50	100 piece
OR 18-3	18,00	24,00	3,00	100 piece
OR 18-3.5	18,00	25,00	3,50	100 piece
OR 18-4	18,00	26,00	4,00	100 piece
OR 18-5	18,00	28,00	5,00	100 piece
OR 18-6	18,00	30,00	6,00	-*
OR 18.1-1.6	18,10	21,30	1,60	-*
OR 18.2-3	18,20	24,20	3,00	-*
OR 18.2-3.8	18,20	25,80	3,80	-*
OR 18.3-3.6	18,30	25,50	3,60	-*
OR 18.4-2.7	18,40	23,80	2,70	100 piece
OR 18.42-5.33	18,42	29,08	5,33	100 piece
OR 18.42-5.34	18,42	29,10	5,34	-*
OR 18.5-1	18,50	20,50	1,00	-*
OR 18.5-1.5	18,50	21,50	1,50	-*
OR 18.5-2	18,50	22,50	2,00	-*
OR 18.5-2.5	18,50	23,50	2,50	-*
OR 18.5-3	18,50	24,50	3,00	-*
OR 18.5-3.5	18,50	25,50	3,50	100 piece
OR 18.6-2.4	18,60	23,40	2,40	-*
OR 18.64-3.53	18,64	25,70	3,53	100 piece
OR 18.72-2.62	18,72	23,96	2,62	100 piece
OR 18.77-1.78	18,77	22,33	1,78	100 piece
OR 19-1	19,00	21,00	1,00	100 piece
OR 19-1.5	19,00	22,00	1,50	100 piece
OR 19-2	19,00	23,00	2,00	100 piece
OR 19-2.5	19,00	24,00	2,50	100 piece
OR 19-2.6	19,00	24,20	2,60	-*
OR 19-3	19,00	25,00	3,00	100 piece
OR 19-3.5	19,00	26,00	3,50	100 piece
OR 19-4	19,00	27,00	4,00	100 piece
OR 19-5	19,00	29,00	5,00	100 piece
OR 19-6	19,00	31,00	6,00	-*
OR 19.05-2.62	19,05	24,29	2,62	100 piece
OR 19.1-1.6	19,10	22,30	1,60	-*
OR 19.18-2.46	19,18	24,10	2,46	100 piece
OR 19.19-2.62	19,19	24,43	2,62	-*
OR 19.2-2.5	19,20	24,20	2,50	100 piece
OR 19.2-3	19,20	25,20	3,00	100 piece
OR 19.3-2.4	19,30	24,10	2,40	100 piece
OR 19.4-2.4	19,40	24,20	2,40	100 piece
OR 19.5-1	19,50	21,50	1,00	-*
OR 19.5-1.5	19,50	22,50	1,50	-*
OR 19.5-2	19,50	23,50	2,00	-*
OR 19.5-2.5	19,50	24,50	2,50	-*
OR 19.5-3	19,50	25,50	3,00	-*
OR 19.5-6	19,50	31,50	6,00	-*
OR 19.6-2.4	19,60	24,40	2,40	100 piece
OR 19.99-5.34	19,99	30,67	5,34	-*

Packaging unit: -\* upon request

Identification	d1 mm	d2 mm	s mm	Packaging unit
OR 20-1	20,00	22,00	1,00	100 piece
OR 20-1.5	20,00	23,00	1,50	100 piece
OR 20-2	20,00	24,00	2,00	100 piece
OR 20-2.4	20,00	24,80	2,40	-*
OR 20-2.5	20,00	25,00	2,50	100 piece
OR 20-2.65	20,00	25,30	2,65	100 piece
OR 20-3	20,00	26,00	3,00	100 piece
OR 20-3.5	20,00	27,00	3,50	100 piece
OR 20-4	20,00	28,00	4,00	100 piece
OR 20-4.5	20,00	29,00	4,50	100 piece
OR 20-5	20,00	30,00	5,00	100 piece
OR 20-6	20,00	32,00	6,00	-*
OR 20.2-3	20,20	26,20	3,00	100 piece
OR 20.22-3.53	20,22	27,28	3,53	100 piece
OR 20.22-4.04	20,22	28,30	4,04	-*
OR 20.29-2.62	20,29	25,53	2,62	100 piece
OR 20.3-2.4	20,30	25,10	2,40	100 piece
OR 20.35-1.78	20,35	23,91	1,78	100 piece
OR 20.5-1	20,50	22,50	1,00	-*
OR 20.5-1.5	20,50	23,50	1,50	-*
OR 20.5-2	20,50	24,50	2,00	-*
OR 20.5-2.5	20,50	25,50	2,50	100 piece
OR 20.5-3	20,50	26,50	3,00	-*
OR 21-1	21,00	23,00	1,00	-*
OR 21-1.5	21,00	24,00	1,50	100 piece
OR 21-2	21,00	25,00	2,00	100 piece
OR 21-2.5	21,00	26,00	2,50	100 piece
OR 21-3	21,00	27,00	3,00	100 piece
OR 21-3.5	21,00	28,00	3,50	100 piece
OR 21-4	21,00	29,00	4,00	100 piece
OR 21-6	21,00	33,00	6,00	-*
OR 21.1-1.6	21,10	24,30	1,60	100 piece
OR 21.2-3	21,20	27,20	3,00	-*
OR 21.3-3.6	21,30	28,50	3,60	100 piece
OR 21.5-1	21,50	23,50	1,00	-*
OR 21.5-1.5	21,50	24,50	1,50	-*
OR 21.5-2	21,50	25,50	2,00	-*
OR 21.5-2.4	21,50	26,30	2,40	-*
OR 21.5-2.5	21,50	26,50	2,50	-*
OR 21.5-3	21,50	27,50	3,00	-*
OR 21.59-5.33	21,59	32,25	5,33	-*
OR 21.6-2.4	21,60	26,40	2,40	-*
OR 21.82-3.53	21,82	28,88	3,53	100 piece
OR 21.89-2.62	21,89	27,13	2,62	100 piece
OR 21.95-1.78	21,95	25,51	1,78	100 piece
OR 22-1	22,00	24,00	1,00	100 piece
OR 22-1.5	22,00	25,00	1,50	100 piece
OR 22-1.6	22,00	25,20	1,60	-*
OR 22-1.8	22,00	25,60	1,80	100 piece
OR 22-2	22,00	26,00	2,00	100 piece
OR 22-2.5	22,00	27,00	2,50	100 piece
OR 22-2.62	22,00	27,24	2,62	100 piece
OR 22-3	22,00	28,00	3,00	100 piece
OR 22-3.5	22,00	29,00	3,50	100 piece
OR 22-4	22,00	30,00	4,00	100 piece
OR 22-4.5	22,00	31,00	4,50	100 piece
OR 22-5	22,00	32,00	5,00	100 piece
OR 22-5.5	22,00	33,00	5,50	25 piece
OR 22-6	22,00	34,00	6,00	-*
OR 22.1-1.6	22,10	25,30	1,60	100 piece
OR 22.2-3	22,20	28,20	3,00	-*
OR 22.22-2.62	22,22	27,46	2,62	100 piece
OR 22.22-3.5	22,22	29,22	3,50	100 piece
OR 22.3-2.4	22,30	27,10	2,40	-*
OR 22.5-1	22,50	24,50	1,00	-*
OR 22.5-1.5	22,50	25,50	1,50	-*
OR 22.5-2	22,50	26,50	2,00	-*
OR 22.5-2.5	22,50	27,50	2,50	-*
OR 22.5-3	22,50	28,50	3,00	-*
OR 23-1	23,00	25,00	1,00	100 piece
OR 23-1.5	23,00	26,00	1,50	100 piece
OR 23-1.75	23,00	26,50	1,75	100 piece
OR 23-2	23,00	27,00	2,00	100 piece
OR 23-2.5	23,00	28,00	2,50	100 piece
OR 23-3	23,00	29,00	3,00	100 piece
OR 23-3.5	23,00	30,00	3,50	100 piece
OR 23-3.6	23,00	30,20	3,60	-*
OR 23-4	23,00	31,00	4,00	100 piece
OR 23-5	23,00	33,00	5,00	25 piece
OR 23-6	23,00	35,00	6,00	-*
OR 23.16-5.34	23,16	33,84	5,34	-*
OR 23.3-2.4	23,30	28,10	2,40	-*
OR 23.4-3.53	23,40	30,46	3,53	100 piece
OR 23.47-2.62	23,47	28,71	2,62	100 piece
OR 23.47-2.95	23,47	29,37	2,95	100 piece
OR 23.5-1	23,50	25,50	1,00	-*
OR 23.5-1.5	23,50	26,50	1,50	-*
OR 23.5-1.78	23,50	27,06	1,78	100 piece

Packaging unit: -\* upon request

Web: <http://cat.hansa-flex.com/en/OR70SHORENBR>

(Continued)

OR 70° Shore NBR

O-ring, 70SH NBR

Identification	d1 mm	d2 mm	s mm	Packaging unit	Identification	d1 mm	d2 mm	s mm	Packaging unit
OR 23.5-2	23,50	27,50	2,00	.*	OR 28-2	28,00	32,00	2,00	100 piece
OR 23.5-2.5	23,50	28,50	2,50	100 piece	OR 28-2.5	28,00	33,00	2,50	.*
OR 23.5-3	23,50	29,50	3,00	.*	OR 28-3	28,00	34,00	3,00	100 piece
OR 23.5-6	23,50	35,50	6,00	.*	OR 28-3.5	28,00	35,00	3,50	100 piece
OR 23.53-1.78	23,53	27,09	1,78	100 piece	OR 28-4	28,00	36,00	4,00	.*
OR 24-1	24,00	26,00	1,00	100 piece	OR 28-4.5	28,00	37,00	4,50	100 piece
OR 24-1.5	24,00	27,00	1,50	100 piece	OR 28-5	28,00	38,00	5,00	25 piece
OR 24-2	24,00	28,00	2,00	100 piece	OR 28-6	28,00	40,00	6,00	.*
OR 24-2.3	24,00	28,60	2,30	.*	OR 28.17-3.53	28,17	35,23	3,53	100 piece
OR 24-2.5	24,00	29,00	2,50	100 piece	OR 28.25-2.62	28,25	33,49	2,62	100 piece
OR 24-3	24,00	30,00	3,00	100 piece	OR 28.3-1.78	28,30	31,86	1,78	100 piece
OR 24-3.5	24,00	31,00	3,50	100 piece	OR 28.39-3.53	28,39	35,45	3,53	.*
OR 24-4	24,00	32,00	4,00	100 piece	OR 28.5-2	28,50	32,50	2,00	.*
OR 24-6	24,00	36,00	6,00	.*	OR 28.5-2.5	28,50	33,50	2,50	.*
OR 24.2-3	24,20	30,20	3,00	100 piece	OR 29-1.5	29,00	32,00	1,50	100 piece
OR 24.2-3.5	24,20	31,20	3,50	100 piece	OR 29-2	29,00	33,00	2,00	100 piece
OR 24.3-2.4	24,30	29,10	2,40	100 piece	OR 29-2.5	29,00	34,00	2,50	100 piece
OR 24.5-1	24,50	26,50	1,00	.*	OR 29-3	29,00	35,00	3,00	100 piece
OR 24.5-1.5	24,50	27,50	1,50	.*	OR 29-3.5	29,00	36,00	3,50	.*
OR 24.5-2	24,50	28,50	2,00	.*	OR 29-4	29,00	37,00	4,00	100 piece
OR 24.5-2.5	24,50	29,50	2,50	.*	OR 29-5	29,00	39,00	5,00	.*
OR 24.5-3	24,50	30,50	3,00	100 piece	OR 29-6	29,00	41,00	6,00	.*
OR 24.6-2.4	24,60	29,40	2,40	.*	OR 29.1-1.6	29,10	32,30	1,60	.*
OR 24.6-3.6	24,60	31,80	3,60	100 piece	OR 29.1-2.55	29,10	34,20	2,55	100 piece
OR 24.77-5.34	24,77	35,45	5,34	.*	OR 29.2-3	29,20	35,20	3,00	100 piece
OR 24.99-3.53	24,99	32,05	3,53	100 piece	OR 29.3-3.6	29,30	36,50	3,60	.*
OR 25-1	25,00	27,00	1,00	100 piece	OR 29.5-1.5	29,50	32,50	1,50	100 piece
OR 25-1.5	25,00	28,00	1,50	100 piece	OR 29.5-2	29,50	33,50	2,00	.*
OR 25-2	25,00	29,00	2,00	100 piece	OR 29.5-2.5	29,50	34,50	2,50	.*
OR 25-2.4	25,00	29,80	2,40	.*	OR 29.5-3	29,50	35,50	3,00	.*
OR 25-2.5	25,00	30,00	2,50	100 piece	OR 29.51-5.34	29,51	40,19	5,34	.*
OR 25-3	25,00	31,00	3,00	100 piece	OR 29.75-3.53	29,75	36,81	3,53	100 piece
OR 25-3.5	25,00	32,00	3,50	.*	OR 29.82-2.62	29,82	35,06	2,62	100 piece
OR 25-3.55	25,00	32,10	3,55	.*	OR 29.87-1.78	29,87	33,43	1,78	100 piece
OR 25-4	25,00	33,00	4,00	100 piece	OR 30-1	30,00	32,00	1,00	100 piece
OR 25-4.5	25,00	34,00	4,50	100 piece	OR 30-1.2	30,00	32,40	1,20	.*
OR 25-5	25,00	35,00	5,00	100 piece	OR 30-1.5	30,00	33,00	1,50	100 piece
OR 25-6	25,00	37,00	6,00	25 piece	OR 30-1.8	30,00	33,60	1,80	100 piece
OR 25.07-2.62	25,07	30,31	2,62	100 piece	OR 30-2	30,00	34,00	2,00	100 piece
OR 25.1-1.6	25,10	28,30	1,60	100 piece	OR 30-2.5	30,00	35,00	2,50	100 piece
OR 25.12-1.78	25,12	28,68	1,78	100 piece	OR 30-2.65	30,00	35,30	2,65	100 piece
OR 25.2-3	25,20	31,20	3,00	.*	OR 30-3	30,00	36,00	3,00	100 piece
OR 25.3-2.4	25,30	30,10	2,40	100 piece	OR 30-3.5	30,00	37,00	3,50	100 piece
OR 25.5-1.5	25,50	28,50	1,50	.*	OR 30-4	30,00	38,00	4,00	100 piece
OR 25.5-2	25,50	29,50	2,00	.*	OR 30-4.5	30,00	39,00	4,50	100 piece
OR 25.5-2.5	25,50	30,50	2,50	100 piece	OR 30-5	30,00	40,00	5,00	25 piece
OR 25.5-3	25,50	31,50	3,00	.*	OR 30-6	30,00	42,00	6,00	25 piece
OR 25.8-3.53	25,80	32,86	3,53	100 piece	OR 30.2-3	30,20	36,20	3,00	100 piece
OR 26-1	26,00	28,00	1,00	100 piece	OR 30.5-2	30,50	34,50	2,00	.*
OR 26-1.5	26,00	29,00	1,50	100 piece	OR 30.5-2.5	30,50	35,50	2,50	.*
OR 26-2	26,00	30,00	2,00	100 piece	OR 30.5-3	30,50	36,50	3,00	.*
OR 26-2.5	26,00	31,00	2,50	100 piece	OR 31-1.5	31,00	34,00	1,50	100 piece
OR 26-3	26,00	32,00	3,00	100 piece	OR 31-2	31,00	35,00	2,00	100 piece
OR 26-3.5	26,00	33,00	3,50	100 piece	OR 31-2.5	31,00	36,00	2,50	100 piece
OR 26-4	26,00	34,00	4,00	100 piece	OR 31-3	31,00	37,00	3,00	100 piece
OR 26-5	26,00	36,00	5,00	.*	OR 31-3.5	31,00	38,00	3,50	.*
OR 26-6	26,00	38,00	6,00	.*	OR 31-4	31,00	39,00	4,00	100 piece
OR 26.2-3	26,20	32,20	3,00	100 piece	OR 31-4.5	31,00	40,00	4,50	25 piece
OR 26.34-5.34	26,34	37,02	5,34	.*	OR 31-5	31,00	41,00	5,00	25 piece
OR 26.5-1.5	26,50	29,50	1,50	.*	OR 31-6	31,00	43,00	6,00	.*
OR 26.5-2	26,50	30,50	2,00	.*	OR 31.12-5.34	31,12	41,80	5,34	.*
OR 26.5-2.5	26,50	31,50	2,50	.*	OR 31.2-3	31,20	37,20	3,00	.*
OR 26.5-3	26,50	32,50	3,00	.*	OR 31.34-3.53	31,34	38,40	3,53	100 piece
OR 26.58-3.53	26,58	33,64	3,53	100 piece	OR 31.42-2.62	31,42	36,66	2,62	100 piece
OR 26.64-2.62	26,64	31,88	2,62	100 piece	OR 31.47-1.78	31,47	35,03	1,78	100 piece
OR 26.7-1.78	26,70	30,26	1,78	100 piece	OR 31.5-2	31,50	35,50	2,00	.*
OR 27-1.5	27,00	30,00	1,50	100 piece	OR 31.5-2.5	31,50	36,50	2,50	.*
OR 27-2	27,00	31,00	2,00	100 piece	OR 31.5-3	31,50	37,50	3,00	.*
OR 27-2.5	27,00	32,00	2,50	100 piece	OR 32-1	32,00	34,00	1,00	100 piece
OR 27-3	27,00	33,00	3,00	100 piece	OR 32-1.5	32,00	35,00	1,50	100 piece
OR 27-3.5	27,00	34,00	3,50	100 piece	OR 32-2	32,00	36,00	2,00	100 piece
OR 27-4	27,00	35,00	4,00	100 piece	OR 32-2.5	32,00	37,00	2,50	.*
OR 27-5	27,00	37,00	5,00	25 piece	OR 32-3	32,00	38,00	3,00	100 piece
OR 27-6	27,00	39,00	6,00	.*	OR 32-3.5	32,00	39,00	3,50	25 piece
OR 27.1-1.6	27,10	30,30	1,60	.*	OR 32-4	32,00	40,00	4,00	100 piece
OR 27.2-3	27,20	33,20	3,00	.*	OR 32-5	32,00	42,00	5,00	25 piece
OR 27.3-2.4	27,30	32,10	2,40	100 piece	OR 32-6	32,00	44,00	6,00	.*
OR 27.4-3.53	27,40	34,46	3,53	100 piece	OR 32.1-1.6	32,10	35,30	1,60	.*
OR 27.5-1.5	27,50	30,50	1,50	.*	OR 32.2-3	32,20	38,20	3,00	100 piece
OR 27.5-2	27,50	31,50	2,00	.*	OR 32.42-1.98	32,42	36,38	1,98	.*
OR 27.5-2.5	27,50	32,50	2,50	.*	OR 32.5-1.5	32,50	35,50	1,50	.*
OR 27.5-3	27,50	33,50	3,00	.*	OR 32.5-2	32,50	36,50	2,00	.*
OR 27.5-3.2	27,50	33,90	3,20	100 piece	OR 32.5-2.5	32,50	37,50	2,50	.*
OR 27.7-3.5	27,70	34,70	3,50	100 piece	OR 32.5-3	32,50	38,50	3,00	.*
OR 27.8-3.6	27,80	35,00	3,60	.*	OR 32.5-3.6	32,50	39,70	3,60	25 piece
OR 27.94-5.34	27,94	38,62	5,34	.*	OR 32.69-5.34	32,69	43,37	5,34	.*
OR 28-1	28,00	30,00	1,00	100 piece	OR 32.7-1.3	32,70	35,30	1,30	.*
OR 28-1.5	28,00	31,00	1,50	100 piece	OR 32.92-1.98	32,92	36,88	1,98	.*

Packaging unit: .\* upon request

Packaging unit: .\* upon request

Web: <http://cat.hansa-flex.com/en/OR70SHORENBR>

**OR 70° Shore NBR**

(Continued)

**O-ring, 70SH NBR**

Identification	d1 mm	d2 mm	s mm	Packaging unit
OR 32.92-3.53	32,92	39,98	3,53	100 piece
OR 33-2	33,00	37,00	2,00	100 piece
OR 33-2.5	33,00	38,00	2,50	100 piece
OR 33-2.62	33,00	38,24	2,62	-*
OR 33-3	33,00	39,00	3,00	100 piece
OR 33-3.5	33,00	40,00	3,50	25 piece
OR 33-4	33,00	41,00	4,00	25 piece
OR 33-5	33,00	43,00	5,00	-*
OR 33-6	33,00	45,00	6,00	-*
OR 33.05-1.78	33,05	36,61	1,78	-*
OR 33.3-2.4	33,30	38,10	2,40	100 piece
OR 33.5-2	33,50	37,50	2,00	-*
OR 33.5-2.5	33,50	38,50	2,50	-*
OR 33.5-3	33,50	39,50	3,00	-*
OR 33.92-3.53	33,92	40,98	3,53	25 piece
OR 33.93-3.53	33,93	40,99	3,53	-*
OR 34-1	34,00	36,00	1,00	100 piece
OR 34-1.5	34,00	37,00	1,50	100 piece
OR 34-2	34,00	38,00	2,00	100 piece
OR 34-2.5	34,00	39,00	2,50	100 piece
OR 34-3	34,00	40,00	3,00	100 piece
OR 34-3.5	34,00	41,00	3,50	25 piece
OR 34-4	34,00	42,00	4,00	100 piece
OR 34-6	34,00	46,00	6,00	-*
OR 34.1-3.6	34,10	41,30	3,60	-*
OR 34.2-3	34,20	40,20	3,00	100 piece
OR 34.29-5.34	34,29	44,97	5,34	-*
OR 34.5-2	34,50	38,50	2,00	-*
OR 34.5-2.5	34,50	39,50	2,50	-*
OR 34.5-3	34,50	40,50	3,00	-*
OR 34.52-3.53	34,52	41,58	3,53	100 piece
OR 34.59-2.62	34,59	39,83	2,62	100 piece
OR 34.6-2.4	34,60	39,40	2,40	-*
OR 34.65-1.78	34,65	38,21	1,78	100 piece
OR 35-1.2	35,00	37,40	1,20	100 piece
OR 35-1.5	35,00	38,00	1,50	100 piece
OR 35-2	35,00	39,00	2,00	100 piece
OR 35-2.5	35,00	40,00	2,50	100 piece
OR 35-3	35,00	41,00	3,00	100 piece
OR 35-3.5	35,00	42,00	3,50	25 piece
OR 35-4	35,00	43,00	4,00	100 piece
OR 35-4.5	35,00	44,00	4,50	25 piece
OR 35-5	35,00	45,00	5,00	25 piece
OR 35-6	35,00	47,00	6,00	-*
OR 35.2-5.7	35,20	46,60	5,70	-*
OR 35.5-2	35,50	39,50	2,00	-*
OR 35.5-2.5	35,50	40,50	2,50	-*
OR 35.5-3	35,50	41,50	3,00	-*
OR 35.5-4	35,50	43,50	4,00	-*
OR 35.6-3.6	35,60	42,80	3,60	25 piece
OR 36-1.2	36,00	38,40	1,20	100 piece
OR 36-1.5	36,00	39,00	1,50	100 piece
OR 36-2	36,00	40,00	2,00	100 piece
OR 36-2.5	36,00	41,00	2,50	100 piece
OR 36-3	36,00	42,00	3,00	100 piece
OR 36-3.5	36,00	43,00	3,50	25 piece
OR 36-4	36,00	44,00	4,00	-*
OR 36-5	36,00	46,00	5,00	-*
OR 36-6	36,00	48,00	6,00	25 piece
OR 36.09-3.53	36,09	43,15	3,53	-*
OR 36.17-2.62	36,17	41,41	2,62	-*
OR 36.2-2.65	36,20	41,50	2,65	-*
OR 36.2-3	36,20	42,20	3,00	-*
OR 36.2-5.7	36,20	47,60	5,70	-*
OR 36.27-1.78	36,27	39,83	1,78	-*
OR 36.5-2	36,50	40,50	2,00	-*
OR 36.5-2.5	36,50	41,50	2,50	-*
OR 36.5-3	36,50	42,50	3,00	-*
OR 36.5-3.5	36,50	43,50	3,50	100 piece
OR 37-1.5	37,00	40,00	1,50	-*
OR 37-2	37,00	41,00	2,00	100 piece
OR 37-2.5	37,00	42,00	2,50	100 piece
OR 37-3	37,00	43,00	3,00	100 piece
OR 37-3.5	37,00	44,00	3,50	25 piece
OR 37-4	37,00	45,00	4,00	100 piece
OR 37-5	37,00	47,00	5,00	25 piece
OR 37-6	37,00	49,00	6,00	-*
OR 37.1-1.6	37,10	40,30	1,60	100 piece
OR 37.2-5.7	37,20	48,60	5,70	-*
OR 37.3-3.6	37,30	44,50	3,60	25 piece
OR 37.47-3	37,47	43,47	3,00	100 piece
OR 37.47-5.33	37,47	48,13	5,33	25 piece
OR 37.47-5.34	37,47	48,15	5,34	-*
OR 37.5-1.5	37,50	40,50	1,50	-*
OR 37.5-2	37,50	41,50	2,00	-*
OR 37.5-2.5	37,50	42,50	2,50	-*
OR 37.5-3	37,50	43,50	3,00	-*
OR 37.69-3.53	37,69	44,75	3,53	100 piece

Packaging unit: -\* upon request

Identification	d1 mm	d2 mm	s mm	Packaging unit
OR 37.77-2.62	37,77	43,01	2,62	-*
OR 37.82-1.78	37,82	41,38	1,78	100 piece
OR 38-1	38,00	40,00	1,00	100 piece
OR 38-1.5	38,00	41,00	1,50	100 piece
OR 38-2	38,00	42,00	2,00	-*
OR 38-2.5	38,00	43,00	2,50	100 piece
OR 38-3	38,00	44,00	3,00	100 piece
OR 38-3.5	38,00	45,00	3,50	100 piece
OR 38-4	38,00	46,00	4,00	100 piece
OR 38-4.5	38,00	47,00	4,50	100 piece
OR 38-5	38,00	48,00	5,00	25 piece
OR 38-6	38,00	50,00	6,00	25 piece
OR 38-10	38,00	58,00	10,00	-*
OR 38.5-2	38,50	42,50	2,00	-*
OR 38.5-2.5	38,50	43,50	2,50	-*
OR 38.5-3	38,50	44,50	3,00	-*
OR 39-1.5	39,00	42,00	1,50	100 piece
OR 39-2	39,00	43,00	2,00	100 piece
OR 39-2.5	39,00	44,00	2,50	100 piece
OR 39-3	39,00	45,00	3,00	100 piece
OR 39-3.5	39,00	46,00	3,50	100 piece
OR 39-4	39,00	47,00	4,00	-*
OR 39-6	39,00	51,00	6,00	-*
OR 39-6.5	39,00	52,00	6,50	-*
OR 39.1-1.3	39,10	41,70	1,30	-*
OR 39.2-3	39,20	45,20	3,00	100 piece
OR 39.2-5.7	39,20	50,60	5,70	25 piece
OR 39.34-2.62	39,34	44,58	2,62	-*
OR 39.45-1.78	39,45	43,01	1,78	-*
OR 39.5-2	39,50	43,50	2,00	-*
OR 39.5-2.5	39,50	44,50	2,50	-*
OR 39.5-3	39,50	45,50	3,00	-*
OR 39.5-6	39,50	51,50	6,00	-*
OR 39.69-3.53	39,69	46,75	3,53	100 piece
OR 39.7-3.53	39,70	46,76	3,53	-*
OR 39.92-3.53	39,92	46,98	3,53	25 piece
OR 40-1	40,00	42,00	1,00	-*
OR 40-1.5	40,00	43,00	1,50	100 piece
OR 40-1.8	40,00	43,60	1,80	100 piece
OR 40-2	40,00	44,00	2,00	100 piece
OR 40-2.5	40,00	45,00	2,50	100 piece
OR 40-3	40,00	46,00	3,00	100 piece
OR 40-3.5	40,00	47,00	3,50	100 piece
OR 40-4	40,00	48,00	4,00	100 piece
OR 40-4.5	40,00	49,00	4,50	100 piece
OR 40-5	40,00	50,00	5,00	25 piece
OR 40-6	40,00	52,00	6,00	25 piece
OR 40-7	40,00	54,00	7,00	25 piece
OR 40.2-3	40,20	46,20	3,00	-*
OR 40.64-5.34	40,64	51,32	5,34	-*
OR 40.65-5.33	40,65	51,31	5,33	-*
OR 40.87-3.53	40,87	47,93	3,53	100 piece
OR 40.95-2.62	40,95	46,19	2,62	100 piece
OR 41-1.78	41,00	44,56	1,78	100 piece
OR 41-2	41,00	45,00	2,00	-*
OR 41-2.5	41,00	46,00	2,50	100 piece
OR 41-3	41,00	47,00	3,00	100 piece
OR 41-3.5	41,00	48,00	3,50	-*
OR 41-4	41,00	49,00	4,00	100 piece
OR 41-5	41,00	51,00	5,00	-*
OR 41-6	41,00	53,00	6,00	-*
OR 41.2-5.7	41,20	52,60	5,70	-*
OR 41.28-3.53	41,28	48,34	3,53	-*
OR 41.5-3	41,50	47,50	3,00	-*
OR 41.5-6	41,50	53,50	6,00	-*
OR 42-1.5	42,00	45,00	1,50	100 piece
OR 42-2	42,00	46,00	2,00	100 piece
OR 42-2.5	42,00	47,00	2,50	100 piece
OR 42-3	42,00	48,00	3,00	100 piece
OR 42-3.5	42,00	49,00	3,50	100 piece
OR 42-4	42,00	50,00	4,00	100 piece
OR 42-4.5	42,00	51,00	4,50	25 piece
OR 42-5	42,00	52,00	5,00	25 piece
OR 42-5.5	42,00	53,00	5,50	25 piece
OR 42-6	42,00	54,00	6,00	-*
OR 42.5-3	42,50	48,50	3,00	-*
OR 42.5-3.55	42,50	49,60	3,55	100 piece
OR 42.5-5.3	42,50	53,10	5,30	-*
OR 42.52-2.62	42,52	47,76	2,62	-*
OR 42.57-3.53	42,57	49,63	3,53	100 piece
OR 42.86-3.53	42,86	49,92	3,53	-*
OR 43-2	43,00	47,00	2,00	100 piece
OR 43-2.5	43,00	48,00	2,50	100 piece
OR 43-3	43,00	49,00	3,00	100 piece
OR 43-3.5	43,00	50,00	3,50	100 piece
OR 43-4	43,00	51,00	4,00	100 piece
OR 43-5.2	43,00	53,40	5,20	-*
OR 43-6	43,00	55,00	6,00	-*

Packaging unit: -\* upon request

Web: <http://cat.hansa-flex.com/en/OR70SHORENBR>



(Continued)

OR 70° Shore NBR

O-ring, 70SH NBR

Identification	d1 mm	d2 mm	s mm	Packaging unit	Identification	d1 mm	d2 mm	s mm	Packaging unit
OR 43.69-3	43,69	49,69	3,00	.*	OR 50-5	50,00	60,00	5,00	25 piece
OR 43.82-5.33	43,82	54,48	5,33	25 piece	OR 50-5.5	50,00	61,00	5,50	25 piece
OR 43.82-5.34	43,82	54,50	5,34	.*	OR 50-6	50,00	62,00	6,00	25 piece
OR 44-1.3	44,00	46,60	1,30	.*	OR 50-7	50,00	64,00	7,00	.*
OR 44-2	44,00	48,00	2,00	100 piece	OR 50.16-5.33	50,16	60,82	5,33	.*
OR 44-2.5	44,00	49,00	2,50	100 piece	OR 50.17-5.34	50,17	60,85	5,34	.*
OR 44-3	44,00	50,00	3,00	100 piece	OR 50.39-3.53	50,39	57,45	3,53	.*
OR 44-3.5	44,00	51,00	3,50	.*	OR 50.4-3.53	50,40	57,46	3,53	100 piece
OR 44-4	44,00	52,00	4,00	100 piece	OR 50.47-2.62	50,47	55,71	2,62	100 piece
OR 44-5	44,00	54,00	5,00	.*	OR 50.5-3	50,50	56,50	3,00	.*
OR 44-6	44,00	56,00	6,00	.*	OR 50.52-1.78	50,52	54,08	1,78	.*
OR 44.04-3.53	44,04	51,10	3,53	100 piece	OR 50.8-1.78	50,80	54,36	1,78	100 piece
OR 44.12-2.62	44,12	49,36	2,62	100 piece	OR 50.8-3.53	50,80	57,86	3,53	.*
OR 44.17-1.78	44,17	47,73	1,78	100 piece	OR 51-2	51,00	55,00	2,00	.*
OR 44.2-5.7	44,20	55,60	5,70	25 piece	OR 51-2.5	51,00	56,00	2,50	100 piece
OR 44.3-5.7	44,30	55,70	5,70	.*	OR 51-3	51,00	57,00	3,00	.*
OR 44.45-3.53	44,45	51,51	3,53	100 piece	OR 51-4	51,00	59,00	4,00	25 piece
OR 44.5-2.5	44,50	49,50	2,50	.*	OR 51-4.5	51,00	60,00	4,50	25 piece
OR 44.5-3	44,50	50,50	3,00	.*	OR 51-5	51,00	61,00	5,00	25 piece
OR 44.5-6	44,50	56,50	6,00	.*	OR 51-6	51,00	63,00	6,00	.*
OR 45-1.5	45,00	48,00	1,50	100 piece	OR 52-1.5	52,00	55,00	1,50	100 piece
OR 45-2	45,00	49,00	2,00	100 piece	OR 52-2	52,00	56,00	2,00	100 piece
OR 45-2.5	45,00	50,00	2,50	100 piece	OR 52-2.5	52,00	57,00	2,50	100 piece
OR 45-3	45,00	51,00	3,00	100 piece	OR 52-2.8	52,00	57,60	2,80	.*
OR 45-3.5	45,00	52,00	3,50	100 piece	OR 52-3	52,00	58,00	3,00	100 piece
OR 45-4	45,00	53,00	4,00	100 piece	OR 52-3.5	52,00	59,00	3,50	25 piece
OR 45-4.5	45,00	54,00	4,50	.*	OR 52-4	52,00	60,00	4,00	100 piece
OR 45-5	45,00	55,00	5,00	25 piece	OR 52-5	52,00	62,00	5,00	.*
OR 45-5.5	45,00	56,00	5,50	25 piece	OR 52-6	52,00	64,00	6,00	25 piece
OR 45-6	45,00	57,00	6,00	25 piece	OR 52.07-2.62	52,07	57,31	2,62	.*
OR 45.3-5.7	45,30	56,70	5,70	.*	OR 52.3-5.7	52,30	63,70	5,70	.*
OR 45.69-2.62	45,69	50,93	2,62	100 piece	OR 52.4-3.53	52,40	59,46	3,53	.*
OR 46-2	46,00	50,00	2,00	100 piece	OR 52.9-5.33	52,90	63,56	5,33	.*
OR 46-2.5	46,00	51,00	2,50	100 piece	OR 53-2	53,00	57,00	2,00	100 piece
OR 46-3	46,00	52,00	3,00	.*	OR 53-2.5	53,00	58,00	2,50	100 piece
OR 46-3.5	46,00	53,00	3,50	100 piece	OR 53-3	53,00	59,00	3,00	100 piece
OR 46-4	46,00	54,00	4,00	100 piece	OR 53-3.5	53,00	60,00	3,50	25 piece
OR 46-4.5	46,00	55,00	4,50	25 piece	OR 53-4	53,00	61,00	4,00	.*
OR 46-5	46,00	56,00	5,00	25 piece	OR 53-5	53,00	63,00	5,00	.*
OR 46-6	46,00	58,00	6,00	.*	OR 53-5.3	53,00	63,60	5,30	25 piece
OR 46.04-3.53	46,04	53,10	3,53	.*	OR 53-6	53,00	65,00	6,00	.*
OR 46.5-2.5	46,50	51,50	2,50	.*	OR 53-7	53,00	67,00	7,00	.*
OR 46.99-5.34	46,99	57,67	5,34	.*	OR 53.34-5.33	53,34	64,00	5,33	25 piece
OR 47-1.2	47,00	49,40	1,20	100 piece	OR 53.34-5.34	53,34	64,02	5,34	.*
OR 47-2	47,00	51,00	2,00	.*	OR 53.57-3.53	53,57	60,63	3,53	100 piece
OR 47-2.5	47,00	52,00	2,50	100 piece	OR 53.64-2.62	53,64	58,88	2,62	.*
OR 47-3	47,00	53,00	3,00	100 piece	OR 53.7-1.78	53,70	57,26	1,78	.*
OR 47-3.5	47,00	54,00	3,50	100 piece	OR 53.97-3.53	53,97	61,03	3,53	.*
OR 47-4	47,00	55,00	4,00	100 piece	OR 54-1.5	54,00	57,00	1,50	100 piece
OR 47-5	47,00	57,00	5,00	.*	OR 54-2	54,00	58,00	2,00	100 piece
OR 47-5.33	47,00	57,66	5,33	25 piece	OR 54-2.5	54,00	59,00	2,50	100 piece
OR 47-5.5	47,00	58,00	5,50	25 piece	OR 54-3	54,00	60,00	3,00	100 piece
OR 47-6	47,00	59,00	6,00	.*	OR 54-3.5	54,00	61,00	3,50	.*
OR 47.2-5.7	47,20	58,60	5,70	.*	OR 54-4	54,00	62,00	4,00	100 piece
OR 47.22-3.53	47,22	54,28	3,53	100 piece	OR 54-5	54,00	64,00	5,00	25 piece
OR 47.29-2.62	47,29	52,53	2,62	.*	OR 54-6	54,00	66,00	6,00	.*
OR 47.35-1.78	47,35	50,91	1,78	.*	OR 54.2-5.7	54,20	65,60	5,70	25 piece
OR 47.6-3.5	47,60	54,60	3,50	.*	OR 54.5-3	54,50	60,50	3,00	.*
OR 47.63-3.53	47,63	54,69	3,53	.*	OR 55-1.5	55,00	58,00	1,50	.*
OR 48-1.8	48,00	51,60	1,80	100 piece	OR 55-2	55,00	59,00	2,00	100 piece
OR 48-2	48,00	52,00	2,00	.*	OR 55-2.5	55,00	60,00	2,50	100 piece
OR 48-2.5	48,00	53,00	2,50	100 piece	OR 55-3	55,00	61,00	3,00	100 piece
OR 48-3	48,00	54,00	3,00	100 piece	OR 55-3.5	55,00	62,00	3,50	25 piece
OR 48-3.5	48,00	55,00	3,50	100 piece	OR 55-4	55,00	63,00	4,00	.*
OR 48-4	48,00	56,00	4,00	100 piece	OR 55-5	55,00	65,00	5,00	25 piece
OR 48-4.5	48,00	57,00	4,50	25 piece	OR 55-6	55,00	67,00	6,00	25 piece
OR 48-5	48,00	58,00	5,00	25 piece	OR 55-7.5	55,00	70,00	7,50	100 piece
OR 48-5.5	48,00	59,00	5,50	25 piece	OR 55.2-5.7	55,20	66,60	5,70	25 piece
OR 48-6	48,00	60,00	6,00	.*	OR 55.25-2.62	55,25	60,49	2,62	.*
OR 48.9-2.62	48,90	54,14	2,62	100 piece	OR 55.3-5.7	55,30	66,70	5,70	.*
OR 49-2	49,00	53,00	2,00	.*	OR 55.56-3.53	55,56	62,62	3,53	25 piece
OR 49-2.5	49,00	54,00	2,50	100 piece	OR 56-1.5	56,00	59,00	1,50	100 piece
OR 49-3	49,00	55,00	3,00	100 piece	OR 56-2	56,00	60,00	2,00	100 piece
OR 49-3.5	49,00	56,00	3,50	100 piece	OR 56-2.5	56,00	61,00	2,50	100 piece
OR 49-4	49,00	57,00	4,00	.*	OR 56-3	56,00	62,00	3,00	100 piece
OR 49-6	49,00	61,00	6,00	.*	OR 56-3.5	56,00	63,00	3,50	25 piece
OR 49.2-3.53	49,20	56,26	3,53	.*	OR 56-3.55	56,00	63,10	3,55	25 piece
OR 49.2-5.7	49,20	60,60	5,70	.*	OR 56-4	56,00	64,00	4,00	100 piece
OR 49.21-3.53	49,21	56,27	3,53	.*	OR 56-5	56,00	66,00	5,00	25 piece
OR 49.3-5.7	49,30	60,70	5,70	.*	OR 56-6	56,00	68,00	6,00	.*
OR 49.5-3	49,50	55,50	3,00	.*	OR 56.2-3	56,20	62,20	3,00	100 piece
OR 50-1.5	50,00	53,00	1,50	100 piece	OR 56.52-5.33	56,52	67,18	5,33	25 piece
OR 50-2	50,00	54,00	2,00	100 piece	OR 56.52-5.34	56,52	67,20	5,34	.*
OR 50-2.5	50,00	55,00	2,50	.*	OR 56.74-3.53	56,74	63,80	3,53	100 piece
OR 50-3	50,00	56,00	3,00	100 piece	OR 56.82-2.62	56,82	62,06	2,62	.*
OR 50-3.5	50,00	57,00	3,50	100 piece	OR 56.87-1.78	56,87	60,43	1,78	.*
OR 50-4	50,00	58,00	4,00	100 piece	OR 57-2	57,00	61,00	2,00	100 piece
OR 50-4.5	50,00	59,00	4,50	25 piece	OR 57-2.5	57,00	62,00	2,50	100 piece

Packaging unit: .\* upon request

Packaging unit: .\* upon request

Web: <http://cat.hansa-flex.com/en/OR70SHORENBR>

## OR 70° Shore NBR

(Continued)

## O-ring, 70SH NBR

Identification	d1 mm	d2 mm	s mm	Packaging unit
OR 57-3	57,00	63,00	3,00	-*
OR 57-3.5	57,00	64,00	3,50	-*
OR 57-4	57,00	65,00	4,00	100 piece
OR 57-5	57,00	67,00	5,00	25 piece
OR 57-6	57,00	69,00	6,00	-*
OR 57-7	57,00	71,00	7,00	-*
OR 57.15-3.53	57,15	64,21	3,53	25 piece
OR 57.2-5.7	57,20	68,60	5,70	-*
OR 58-1.5	58,00	61,00	1,50	100 piece
OR 58-2	58,00	62,00	2,00	100 piece
OR 58-2.5	58,00	63,00	2,50	100 piece
OR 58-3	58,00	64,00	3,00	100 piece
OR 58-3.5	58,00	65,00	3,50	25 piece
OR 58-4	58,00	66,00	4,00	25 piece
OR 58-5	58,00	68,00	5,00	25 piece
OR 58-6	58,00	70,00	6,00	25 piece
OR 58-7	58,00	72,00	7,00	-*
OR 58-8	58,00	74,00	8,00	-*
OR 58.42-2.62	58,42	63,66	2,62	100 piece
OR 58.74-3.53	58,74	65,80	3,53	-*
OR 59-2	59,00	63,00	2,00	-*
OR 59-2.5	59,00	64,00	2,50	100 piece
OR 59-3	59,00	65,00	3,00	-*
OR 59-4	59,00	67,00	4,00	-*
OR 59-7	59,00	73,00	7,00	-*
OR 59.2-5.7	59,20	70,60	5,70	25 piece
OR 59.3-5.7	59,30	70,70	5,70	-*
OR 59.5-3	59,50	65,50	3,00	-*
OR 59.5-6	59,50	71,50	6,00	-*
OR 59.69-5.34	59,69	70,37	5,34	-*
OR 59.92-3.53	59,92	66,98	3,53	100 piece
OR 60-1.5	60,00	63,00	1,50	-*
OR 60-2	60,00	64,00	2,00	100 piece
OR 60-2.5	60,00	65,00	2,50	-*
OR 60-2.62	60,00	65,24	2,62	100 piece
OR 60-3	60,00	66,00	3,00	-*
OR 60-3.5	60,00	67,00	3,50	25 piece
OR 60-4	60,00	68,00	4,00	100 piece
OR 60-4.5	60,00	69,00	4,50	25 piece
OR 60-5	60,00	70,00	5,00	25 piece
OR 60-5.3	60,00	70,60	5,30	25 piece
OR 60-5.4	60,00	70,80	5,40	-*
OR 60-6	60,00	72,00	6,00	-*
OR 60-7	60,00	74,00	7,00	25 piece
OR 60.04-1.78	60,04	63,60	1,78	100 piece
OR 60.05-1.78	60,05	63,61	1,78	-*
OR 60.32-3.53	60,32	67,38	3,53	-*
OR 61-2	61,00	65,00	2,00	100 piece
OR 61-2.5	61,00	66,00	2,50	-*
OR 61-3	61,00	67,00	3,00	25 piece
OR 61-3.5	61,00	68,00	3,50	-*
OR 61-4	61,00	69,00	4,00	-*
OR 61-5	61,00	71,00	5,00	25 piece
OR 61-5.33	61,00	71,66	5,33	-*
OR 61-6	61,00	73,00	6,00	-*
OR 61.2-5.7	61,20	72,60	5,70	-*
OR 61.6-2.62	61,60	66,84	2,62	-*
OR 61.9-3.53	61,90	68,96	3,53	-*
OR 62-2	62,00	66,00	2,00	100 piece
OR 62-2.5	62,00	67,00	2,50	100 piece
OR 62-3	62,00	68,00	3,00	100 piece
OR 62-3.5	62,00	69,00	3,50	25 piece
OR 62-4	62,00	70,00	4,00	25 piece
OR 62-5	62,00	72,00	5,00	25 piece
OR 62-5.7	62,00	73,40	5,70	-*
OR 62-6	62,00	74,00	6,00	-*
OR 62-7	62,00	76,00	7,00	-*
OR 62.3-5.7	62,30	73,70	5,70	-*
OR 62.87-5.33	62,87	73,53	5,33	25 piece
OR 62.87-5.34	62,87	73,55	5,34	-*
OR 63-1.5	63,00	66,00	1,50	100 piece
OR 63-2	63,00	67,00	2,00	100 piece
OR 63-2.5	63,00	68,00	2,50	100 piece
OR 63-3	63,00	69,00	3,00	25 piece
OR 63-3.5	63,00	70,00	3,50	25 piece
OR 63-4	63,00	71,00	4,00	25 piece
OR 63-4.5	63,00	72,00	4,50	25 piece
OR 63-5	63,00	73,00	5,00	-*
OR 63-6	63,00	75,00	6,00	-*
OR 63-9	63,00	81,00	9,00	-*
OR 63.09-3.53	63,09	70,15	3,53	100 piece
OR 63.17-2.62	63,17	68,41	2,62	100 piece
OR 63.22-1.78	63,22	66,78	1,78	-*
OR 63.5-3.53	63,50	70,56	3,53	-*
OR 64-2	64,00	68,00	2,00	-*
OR 64-2.5	64,00	69,00	2,50	100 piece
OR 64-3	64,00	70,00	3,00	100 piece
OR 64-3.5	64,00	71,00	3,50	25 piece

Packaging unit: -\* upon request

Identification	d1 mm	d2 mm	s mm	Packaging unit
OR 64-4	64,00	72,00	4,00	25 piece
OR 64-4.5	64,00	73,00	4,50	25 piece
OR 64-5	64,00	74,00	5,00	25 piece
OR 64-6	64,00	76,00	6,00	25 piece
OR 64.3-5.7	64,30	75,70	5,70	-*
OR 64.5-3	64,50	70,50	3,00	-*
OR 64.77-2.62	64,77	70,01	2,62	-*
OR 65-1.5	65,00	68,00	1,50	100 piece
OR 65-2	65,00	69,00	2,00	100 piece
OR 65-2.5	65,00	70,00	2,50	100 piece
OR 65-3	65,00	71,00	3,00	100 piece
OR 65-3.5	65,00	72,00	3,50	25 piece
OR 65-4	65,00	73,00	4,00	100 piece
OR 65-5	65,00	75,00	5,00	25 piece
OR 65-5.5	65,00	76,00	5,50	25 piece
OR 65-6	65,00	77,00	6,00	-*
OR 65.1-3.53	65,10	72,16	3,53	-*
OR 66-2	66,00	70,00	2,00	100 piece
OR 66-2.5	66,00	71,00	2,50	-*
OR 66-3	66,00	72,00	3,00	-*
OR 66-4	66,00	74,00	4,00	-*
OR 66-5	66,00	76,00	5,00	25 piece
OR 66-6	66,00	78,00	6,00	-*
OR 66.04-5.33	66,04	76,70	5,33	25 piece
OR 66.04-5.34	66,04	76,72	5,34	-*
OR 66.27-3.53	66,27	73,33	3,53	-*
OR 66.34-2.62	66,34	71,58	2,62	-*
OR 66.4-1.78	66,40	69,96	1,78	-*
OR 67-2	67,00	71,00	2,00	100 piece
OR 67-2.5	67,00	72,00	2,50	100 piece
OR 67-3	67,00	73,00	3,00	-*
OR 67-4	67,00	75,00	4,00	-*
OR 67-6	67,00	79,00	6,00	-*
OR 67.2-5.7	67,20	78,60	5,70	-*
OR 67.95-2.62	67,95	73,19	2,62	-*
OR 68-2	68,00	72,00	2,00	100 piece
OR 68-2.5	68,00	73,00	2,50	-*
OR 68-3	68,00	74,00	3,00	100 piece
OR 68-3.5	68,00	75,00	3,50	25 piece
OR 68-4	68,00	76,00	4,00	-*
OR 68-5	68,00	78,00	5,00	25 piece
OR 68-5.5	68,00	79,00	5,50	-*
OR 68-6	68,00	80,00	6,00	25 piece
OR 68-7	68,00	82,00	7,00	25 piece
OR 68-10	68,00	88,00	10,00	-*
OR 68.26-3.53	68,26	75,32	3,53	-*
OR 69-2.5	69,00	74,00	2,50	-*
OR 69-3	69,00	75,00	3,00	25 piece
OR 69-4	69,00	77,00	4,00	-*
OR 69-5	69,00	79,00	5,00	-*
OR 69-6	69,00	81,00	6,00	-*
OR 69.22-5.34	69,22	79,90	5,34	-*
OR 69.3-5.7	69,30	80,70	5,70	-*
OR 69.44-3.53	69,44	76,50	3,53	100 piece
OR 69.5-3	69,50	75,50	3,00	-*
OR 69.52-2.62	69,52	74,76	2,62	100 piece
OR 69.57-1.78	69,57	73,13	1,78	-*
OR 69.85-3.53	69,85	76,91	3,53	-*
OR 70-1.78	70,00	73,56	1,78	100 piece
OR 70-2	70,00	74,00	2,00	100 piece
OR 70-2.5	70,00	75,00	2,50	100 piece
OR 70-3	70,00	76,00	3,00	100 piece
OR 70-3.5	70,00	77,00	3,50	25 piece
OR 70-4	70,00	78,00	4,00	25 piece
OR 70-4.5	70,00	79,00	4,50	-*
OR 70-5	70,00	80,00	5,00	25 piece
OR 70-5.5	70,00	81,00	5,50	25 piece
OR 70-6	70,00	82,00	6,00	25 piece
OR 70-7	70,00	84,00	7,00	25 piece
OR 71-2	71,00	75,00	2,00	25 piece
OR 71-3	71,00	77,00	3,00	25 piece
OR 71-4	71,00	79,00	4,00	-*
OR 71.12-2.62	71,12	76,36	2,62	-*
OR 71.2-5.7	71,20	82,60	5,70	-*
OR 71.44-3.53	71,44	78,50	3,53	-*
OR 72-2	72,00	76,00	2,00	100 piece
OR 72-2.5	72,00	77,00	2,50	100 piece
OR 72-3	72,00	78,00	3,00	-*
OR 72-3.5	72,00	79,00	3,50	25 piece
OR 72-4	72,00	80,00	4,00	25 piece
OR 72-5	72,00	82,00	5,00	25 piece
OR 72-6	72,00	84,00	6,00	25 piece
OR 72.2-5.7	72,20	83,60	5,70	-*
OR 72.39-5.34	72,39	83,07	5,34	-*
OR 72.62-3.53	72,62	79,68	3,53	25 piece
OR 72.69-2.62	72,69	77,93	2,62	-*
OR 72.75-1.78	72,75	76,31	1,78	-*
OR 73-2	73,00	77,00	2,00	25 piece

Packaging unit: -\* upon request

Web: <http://cat.hansa-flex.com/en/OR70SHORENBR>

(Continued)

OR 70° Shore NBR

O-ring, 70SH NBR

Identification	d1 mm	d2 mm	s mm	Packaging unit
OR 73-2.5	73,00	78,00	2,50	25 piece
OR 73-3	73,00	79,00	3,00	25 piece
OR 73-3.5	73,00	80,00	3,50	25 piece
OR 73-4	73,00	81,00	4,00	.*
OR 73-5	73,00	83,00	5,00	25 piece
OR 73-6	73,00	85,00	6,00	.*
OR 73-7	73,00	87,00	7,00	100 piece
OR 73.02-3.53	73,02	80,08	3,53	.*
OR 74-1.5	74,00	77,00	1,50	25 piece
OR 74-2	74,00	78,00	2,00	100 piece
OR 74-2.5	74,00	79,00	2,50	25 piece
OR 74-3	74,00	80,00	3,00	25 piece
OR 74-3.5	74,00	81,00	3,50	25 piece
OR 74-4	74,00	82,00	4,00	.*
OR 74-6	74,00	86,00	6,00	25 piece
OR 74-7	74,00	88,00	7,00	25 piece
OR 74.2-5.7	74,20	85,60	5,70	.*
OR 74.3-2.62	74,30	79,54	2,62	.*
OR 74.3-5.7	74,30	85,70	5,70	.*
OR 74.5-3	74,50	80,50	3,00	.*
OR 74.6-3.53	74,60	81,66	3,53	.*
OR 74.63-5.34	74,63	85,31	5,34	.*
OR 75-2	75,00	79,00	2,00	100 piece
OR 75-2.5	75,00	80,00	2,50	100 piece
OR 75-3	75,00	81,00	3,00	25 piece
OR 75-3.5	75,00	82,00	3,50	25 piece
OR 75-4	75,00	83,00	4,00	25 piece
OR 75-4.5	75,00	84,00	4,50	.*
OR 75-5	75,00	85,00	5,00	25 piece
OR 75-6	75,00	87,00	6,00	25 piece
OR 75-7	75,00	89,00	7,00	.*
OR 75.57-5.34	75,57	86,25	5,34	.*
OR 75.79-3.53	75,79	82,85	3,53	.*
OR 75.87-2.62	75,87	81,11	2,62	.*
OR 75.92-1.78	75,92	79,48	1,78	.*
OR 76-2	76,00	80,00	2,00	.*
OR 76-2.5	76,00	81,00	2,50	25 piece
OR 76-3	76,00	82,00	3,00	25 piece
OR 76-3.5	76,00	83,00	3,50	25 piece
OR 76-4	76,00	84,00	4,00	.*
OR 76-6	76,00	88,00	6,00	.*
OR 77-3	77,00	83,00	3,00	.*
OR 77-4	77,00	85,00	4,00	.*
OR 77.2-5.7	77,20	88,60	5,70	.*
OR 77.5-2.62	77,50	82,74	2,62	.*
OR 77.5-3.55	77,50	84,60	3,55	.*
OR 78-1.5	78,00	81,00	1,50	.*
OR 78-2	78,00	82,00	2,00	.*
OR 78-3	78,00	84,00	3,00	.*
OR 78-3.5	78,00	85,00	3,50	25 piece
OR 78-4	78,00	86,00	4,00	25 piece
OR 78-4.3	78,00	86,60	4,30	25 piece
OR 78-5	78,00	88,00	5,00	.*
OR 78-5.5	78,00	89,00	5,50	25 piece
OR 78-6	78,00	90,00	6,00	.*
OR 78.5-5.33	78,50	89,16	5,33	.*
OR 78.5-6	78,50	90,50	6,00	.*
OR 78.74-5.33	78,74	89,40	5,33	25 piece
OR 78.74-5.34	78,74	89,42	5,34	.*
OR 78.97-3.53	78,97	86,03	3,53	25 piece
OR 79-1.78	79,00	82,56	1,78	.*
OR 79-2	79,00	83,00	2,00	25 piece
OR 79-3	79,00	85,00	3,00	.*
OR 79-4	79,00	87,00	4,00	.*
OR 79-6	79,00	91,00	6,00	.*
OR 79-7	79,00	93,00	7,00	.*
OR 79.2-5.7	79,20	90,60	5,70	25 piece
OR 79.3-5.7	79,30	90,70	5,70	.*
OR 79.5-3	79,50	85,50	3,00	.*
OR 79.73-5.34	79,73	90,41	5,34	.*
OR 80-1.5	80,00	83,00	1,50	25 piece
OR 80-2	80,00	84,00	2,00	100 piece
OR 80-2.5	80,00	85,00	2,50	25 piece
OR 80-3	80,00	86,00	3,00	25 piece
OR 80-3.5	80,00	87,00	3,50	25 piece
OR 80-4	80,00	88,00	4,00	25 piece
OR 80-5	80,00	90,00	5,00	25 piece
OR 80-5.5	80,00	91,00	5,50	25 piece
OR 80-6	80,00	92,00	6,00	25 piece
OR 80.6-2.62	80,60	85,84	2,62	.*
OR 81-2	81,00	85,00	2,00	.*
OR 81-3	81,00	87,00	3,00	25 piece
OR 81-4	81,00	89,00	4,00	.*
OR 81-6	81,00	93,00	6,00	.*
OR 81.2-5.7	81,20	92,60	5,70	.*
OR 81.5-6	81,50	93,50	6,00	.*
OR 81.92-5.34	81,92	92,60	5,34	.*
OR 82-1.5	82,00	85,00	1,50	.*

Packaging unit: .\* upon request

Identification	d1 mm	d2 mm	s mm	Packaging unit
OR 82-2	82,00	86,00	2,00	25 piece
OR 82-2.5	82,00	87,00	2,50	25 piece
OR 82-3	82,00	88,00	3,00	25 piece
OR 82-3.5	82,00	89,00	3,50	25 piece
OR 82-4	82,00	90,00	4,00	25 piece
OR 82-5	82,00	92,00	5,00	25 piece
OR 82-7	82,00	96,00	7,00	.*
OR 82.14-3.53	82,14	89,20	3,53	25 piece
OR 82.2-5.7	82,20	93,60	5,70	.*
OR 82.22-2.62	82,22	87,46	2,62	.*
OR 82.27-1.78	82,27	85,83	1,78	.*
OR 83-2	83,00	87,00	2,00	25 piece
OR 83-2.5	83,00	88,00	2,50	25 piece
OR 83-3	83,00	89,00	3,00	100 piece
OR 83-4	83,00	91,00	4,00	.*
OR 83-5	83,00	93,00	5,00	.*
OR 83.8-2.62	83,80	89,04	2,62	.*
OR 84-3	84,00	90,00	3,00	25 piece
OR 84-4	84,00	92,00	4,00	25 piece
OR 84-5	84,00	94,00	5,00	.*
OR 84-6	84,00	96,00	6,00	.*
OR 84.2-5.7	84,20	95,60	5,70	.*
OR 84.3-5.7	84,30	95,70	5,70	.*
OR 84.5-3	84,50	90,50	3,00	.*
OR 85-2	85,00	89,00	2,00	25 piece
OR 85-2.5	85,00	90,00	2,50	25 piece
OR 85-3	85,00	91,00	3,00	25 piece
OR 85-3.5	85,00	92,00	3,50	.*
OR 85-4	85,00	93,00	4,00	25 piece
OR 85-4.5	85,00	94,00	4,50	25 piece
OR 85-5	85,00	95,00	5,00	25 piece
OR 85-6	85,00	97,00	6,00	.*
OR 85-7	85,00	99,00	7,00	25 piece
OR 85.09-5.33	85,09	95,75	5,33	25 piece
OR 85.09-5.34	85,09	95,77	5,34	.*
OR 85.32-3.53	85,32	92,38	3,53	25 piece
OR 85.34-1.78	85,34	88,90	1,78	.*
OR 86-2	86,00	90,00	2,00	25 piece
OR 86-2.5	86,00	91,00	2,50	25 piece
OR 86-3	86,00	92,00	3,00	25 piece
OR 86-4	86,00	94,00	4,00	25 piece
OR 86-5	86,00	96,00	5,00	25 piece
OR 86-6	86,00	98,00	6,00	.*
OR 86-7.5	86,00	101,00	7,50	.*
OR 86.5-3	86,50	92,50	3,00	.*
OR 87-2.5	87,00	92,00	2,50	.*
OR 87-3	87,00	93,00	3,00	25 piece
OR 87-4	87,00	95,00	4,00	25 piece
OR 87-5	87,00	97,00	5,00	25 piece
OR 87.2-5.7	87,20	98,60	5,70	.*
OR 88-2	88,00	92,00	2,00	.*
OR 88-3	88,00	94,00	3,00	25 piece
OR 88-3.5	88,00	95,00	3,50	25 piece
OR 88-4	88,00	96,00	4,00	25 piece
OR 88-5	88,00	98,00	5,00	25 piece
OR 88-6	88,00	100,00	6,00	25 piece
OR 88.27-5.33	88,27	98,93	5,33	.*
OR 88.27-5.34	88,27	98,95	5,34	.*
OR 88.49-3.53	88,49	95,55	3,53	.*
OR 88.57-2.62	88,57	93,81	2,62	.*
OR 88.62-1.78	88,62	92,18	1,78	.*
OR 89-3	89,00	95,00	3,00	.*
OR 89-3.5	89,00	96,00	3,50	.*
OR 89-4	89,00	97,00	4,00	.*
OR 89-7	89,00	103,00	7,00	.*
OR 89.2-5.7	89,20	100,60	5,70	25 piece
OR 89.5-3	89,50	95,50	3,00	.*
OR 89.69-5.33	89,69	100,35	5,33	25 piece
OR 89.69-5.34	89,69	100,37	5,34	.*
OR 90-2	90,00	94,00	2,00	25 piece
OR 90-2.5	90,00	95,00	2,50	25 piece
OR 90-3	90,00	96,00	3,00	25 piece
OR 90-3.5	90,00	97,00	3,50	25 piece
OR 90-4	90,00	98,00	4,00	25 piece
OR 90-5	90,00	100,00	5,00	25 piece
OR 90-5.5	90,00	101,00	5,50	25 piece
OR 90-6	90,00	102,00	6,00	25 piece
OR 90-7	90,00	104,00	7,00	.*
OR 91-3	91,00	97,00	3,00	.*
OR 91-4	91,00	99,00	4,00	.*
OR 91.44-5.34	91,44	102,12	5,34	.*
OR 91.67-3.53	91,67	98,73	3,53	.*
OR 91.7-1.78	91,70	95,26	1,78	25 piece
OR 92-2	92,00	96,00	2,00	25 piece
OR 92-2.5	92,00	97,00	2,50	25 piece
OR 92-3	92,00	98,00	3,00	25 piece
OR 92-3.5	92,00	99,00	3,50	25 piece
OR 92-4	92,00	100,00	4,00	.*

Packaging unit: .\* upon request

Web: <http://cat.hansa-flex.com/en/OR70SHORENBR>

**OR 70° Shore NBR**

(Continued)

**O-ring, 70SH NBR**

Identification	d1 mm	d2 mm	s mm	Packaging unit
OR 92-5	92,00	102,00	5,00	25 piece
OR 92-6	92,00	104,00	6,00	-*
OR 92.2-5.7	92,20	103,60	5,70	-*
OR 92.5-3.53	92,50	99,56	3,53	-*
OR 93-3	93,00	99,00	3,00	25 piece
OR 93-3.5	93,00	100,00	3,50	25 piece
OR 93-4	93,00	101,00	4,00	-*
OR 93-5	93,00	103,00	5,00	25 piece
OR 93-6	93,00	105,00	6,00	-*
OR 94-2.5	94,00	99,00	2,50	25 piece
OR 94-3	94,00	100,00	3,00	25 piece
OR 94-3.5	94,00	101,00	3,50	25 piece
OR 94-4	94,00	102,00	4,00	25 piece
OR 94-5	94,00	104,00	5,00	-*
OR 94.3-5.7	94,30	105,70	5,70	-*
OR 94.5-3	94,50	100,50	3,00	-*
OR 94.62-5.34	94,62	105,30	5,34	-*
OR 94.84-3.53	94,84	101,90	3,53	100 piece
OR 94.92-2.62	94,92	100,16	2,62	-*
OR 94.93-2.62	94,93	100,17	2,62	-*
OR 94.97-1.78	94,97	98,53	1,78	-*
OR 95-1.5	95,00	98,00	1,50	25 piece
OR 95-2	95,00	99,00	2,00	25 piece
OR 95-2.5	95,00	100,00	2,50	25 piece
OR 95-3	95,00	101,00	3,00	25 piece
OR 95-3.5	95,00	102,00	3,50	25 piece
OR 95-4	95,00	103,00	4,00	25 piece
OR 95-4.5	95,00	104,00	4,50	25 piece
OR 95-5	95,00	105,00	5,00	-*
OR 95-6	95,00	107,00	6,00	25 piece
OR 95-7	95,00	109,00	7,00	-*
OR 95-8	95,00	111,00	8,00	-*
OR 96-2.5	96,00	101,00	2,50	25 piece
OR 96-3	96,00	102,00	3,00	25 piece
OR 96-4	96,00	104,00	4,00	25 piece
OR 96-6	96,00	108,00	6,00	-*
OR 97-3	97,00	103,00	3,00	-*
OR 97-4	97,00	105,00	4,00	-*
OR 97-5	97,00	107,00	5,00	25 piece
OR 97.2-5.7	97,20	108,60	5,70	-*
OR 97.79-5.34	97,79	108,47	5,34	-*
OR 97.8-5.33	97,80	108,46	5,33	25 piece
OR 98-2	98,00	102,00	2,00	-*
OR 98-3	98,00	104,00	3,00	25 piece
OR 98-4	98,00	106,00	4,00	-*
OR 98-4.5	98,00	107,00	4,50	25 piece
OR 98-5	98,00	108,00	5,00	25 piece
OR 98-6	98,00	110,00	6,00	-*
OR 98.02-3.53	98,02	105,08	3,53	25 piece
OR 98.05-1.78	98,05	101,61	1,78	-*
OR 99-3	99,00	105,00	3,00	-*
OR 99-4	99,00	107,00	4,00	-*
OR 99-5	99,00	109,00	5,00	25 piece
OR 99-6	99,00	111,00	6,00	-*
OR 99-7	99,00	113,00	7,00	-*
OR 99.3-5.7	99,30	110,70	5,70	-*
OR 99.5-3	99,50	105,50	3,00	-*
OR 100-1	100,00	102,00	1,00	25 piece
OR 100-1.5	100,00	103,00	1,50	25 piece
OR 100-2	100,00	104,00	2,00	25 piece
OR 100-2.5	100,00	105,00	2,50	25 piece
OR 100-3	100,00	106,00	3,00	25 piece
OR 100-3.5	100,00	107,00	3,50	25 piece
OR 100-4	100,00	108,00	4,00	25 piece
OR 100-5	100,00	110,00	5,00	25 piece
OR 100-5.3	100,00	110,60	5,30	25 piece
OR 100-5.34	100,00	110,68	5,34	-*
OR 100-5.5	100,00	111,00	5,50	-*
OR 100-6	100,00	112,00	6,00	25 piece
OR 100-7	100,00	114,00	7,00	25 piece
OR 100-10	100,00	120,00	10,00	-*
OR 100.97-5.33	100,97	111,63	5,33	-*
OR 100.97-5.34	100,97	111,65	5,34	-*
OR 101-3	101,00	107,00	3,00	-*
OR 101-3.5	101,00	108,00	3,50	-*
OR 101-4	101,00	109,00	4,00	-*
OR 101-6	101,00	113,00	6,00	-*
OR 101.2-3.53	101,20	108,26	3,53	-*
OR 101.27-2.62	101,27	106,51	2,62	100 piece
OR 101.32-1.78	101,32	104,88	1,78	-*
OR 102-3	102,00	108,00	3,00	-*
OR 102-3.5	102,00	109,00	3,50	-*
OR 102-4	102,00	110,00	4,00	-*
OR 102-5	102,00	112,00	5,00	-*
OR 103-3	103,00	109,00	3,00	-*
OR 103-3.5	103,00	110,00	3,50	-*
OR 103-4	103,00	111,00	4,00	-*
OR 103-6	103,00	115,00	6,00	-*

Packaging unit: -\* upon request

Identification	d1 mm	d2 mm	s mm	Packaging unit
OR 104-2.5	104,00	109,00	2,50	-*
OR 104-3	104,00	110,00	3,00	-*
OR 104-4	104,00	112,00	4,00	-*
OR 104-6	104,00	116,00	6,00	-*
OR 104-7	104,00	118,00	7,00	-*
OR 104.14-5.33	104,14	114,80	5,33	-*
OR 104.14-5.34	104,14	114,82	5,34	-*
OR 104.2-5.7	104,20	115,60	5,70	-*
OR 104.3-5.7	104,30	115,70	5,70	-*
OR 104.37-3.53	104,37	111,43	3,53	-*
OR 104.4-1.78	104,40	107,96	1,78	-*
OR 104.5-3	104,50	110,50	3,00	-*
OR 104.5-6	104,50	116,50	6,00	-*
OR 105-1.5	105,00	108,00	1,50	-*
OR 105-2	105,00	109,00	2,00	-*
OR 105-3	105,00	111,00	3,00	-*
OR 105-3.5	105,00	112,00	3,50	-*
OR 105-4	105,00	113,00	4,00	-*
OR 105-4.5	105,00	114,00	4,50	-*
OR 105-5	105,00	115,00	5,00	-*
OR 105-5.5	105,00	116,00	5,50	-*
OR 105-6	105,00	117,00	6,00	-*
OR 105-7	105,00	119,00	7,00	-*
OR 105-7.5	105,00	120,00	7,50	-*
OR 106-3	106,00	112,00	3,00	-*
OR 106-4	106,00	114,00	4,00	-*
OR 106-5	106,00	116,00	5,00	-*
OR 106-6	106,00	118,00	6,00	-*
OR 106-7	106,00	120,00	7,00	-*
OR 107-3	107,00	113,00	3,00	-*
OR 107-3.5	107,00	114,00	3,50	-*
OR 107-4	107,00	115,00	4,00	-*
OR 107-5	107,00	117,00	5,00	-*
OR 107-6	107,00	119,00	6,00	-*
OR 107.32-5.34	107,32	118,00	5,34	-*
OR 107.54-3.53	107,54	114,60	3,53	-*
OR 107.6-3.6	107,60	114,80	3,60	-*
OR 107.62-2.62	107,62	112,86	2,62	-*
OR 107.63-2.62	107,63	112,87	2,62	-*
OR 107.67-1.78	107,67	111,23	1,78	-*
OR 107.7-1.78	107,70	111,26	1,78	-*
OR 108-2.5	108,00	113,00	2,50	-*
OR 108-3	108,00	114,00	3,00	-*
OR 108-4	108,00	116,00	4,00	-*
OR 108-5	108,00	118,00	5,00	-*
OR 108-6	108,00	120,00	6,00	-*
OR 108-7	108,00	122,00	7,00	-*
OR 109-3	109,00	115,00	3,00	-*
OR 109-4	109,00	117,00	4,00	-*
OR 109.3-5.7	109,30	120,70	5,70	-*
OR 109.5-3	109,50	115,50	3,00	-*
OR 109.54-5.34	109,54	120,22	5,34	-*
OR 110-2	110,00	114,00	2,00	-*
OR 110-2.5	110,00	115,00	2,50	-*
OR 110-3	110,00	116,00	3,00	-*
OR 110-3.5	110,00	117,00	3,50	-*
OR 110-4	110,00	118,00	4,00	-*
OR 110-4.5	110,00	119,00	4,50	-*
OR 110-5	110,00	120,00	5,00	-*
OR 110-5.5	110,00	121,00	5,50	-*
OR 110-6	110,00	122,00	6,00	-*
OR 110-7	110,00	124,00	7,00	-*
OR 110.49-5.34	110,49	121,17	5,34	-*
OR 110.55-3.53	110,55	117,61	3,53	-*
OR 110.72-3.53	110,72	117,78	3,53	-*
OR 110.74-1.78	110,74	114,30	1,78	-*
OR 111-3	111,00	117,00	3,00	-*
OR 111-4	111,00	119,00	4,00	-*
OR 111-6	111,00	123,00	6,00	-*
OR 112-2.5	112,00	117,00	2,50	-*
OR 112-3	112,00	118,00	3,00	-*
OR 112-4	112,00	120,00	4,00	-*
OR 112-5	112,00	122,00	5,00	-*
OR 112-6	112,00	124,00	6,00	-*
OR 113-2.5	113,00	118,00	2,50	-*
OR 113-3	113,00	119,00	3,00	-*
OR 113-3.5	113,00	120,00	3,50	-*
OR 113-4	113,00	121,00	4,00	-*
OR 113.67-5.34	113,67	124,35	5,34	-*
OR 113.67-7	113,67	127,67	7,00	-*
OR 113.89-3.53	113,89	120,95	3,53	-*
OR 113.9-3.53	113,90	120,96	3,53	-*
OR 113.97-2.62	113,97	119,21	2,62	-*
OR 114-3	114,00	120,00	3,00	-*
OR 114-3.5	114,00	121,00	3,50	-*
OR 114-4	114,00	122,00	4,00	-*
OR 114-5	114,00	124,00	5,00	-*
OR 114-6	114,00	126,00	6,00	-*

Packaging unit: -\* upon request

Web: <http://cat.hansa-flex.com/en/OR70SHORENBR>

(Continued)

OR 70° Shore NBR

O-ring, 70SH NBR

Identification	d1 mm	d2 mm	s mm	Packaging unit	Identification	d1 mm	d2 mm	s mm	Packaging unit
OR 114.02-1.78	114,02	117,58	1,78	.*	OR 126-4.5	126,00	135,00	4,50	.*
OR 114.3-5.7	114,30	125,70	5,70	.*	OR 126.37-5.34	126,37	137,05	5,34	.*
OR 114.5-3	114,50	120,50	3,00	.*	OR 126.37-7	126,37	140,37	7,00	.*
OR 114.6-5.7	114,60	126,00	5,70	.*	OR 126.59-3.53	126,59	133,65	3,53	.*
OR 114.7-7	114,70	128,70	7,00	.*	OR 126.67-2.62	126,67	131,91	2,62	.*
OR 115-2	115,00	119,00	2,00	.*	OR 126.72-1.78	126,72	130,28	1,78	.*
OR 115-3	115,00	121,00	3,00	.*	OR 127-3	127,00	133,00	3,00	.*
OR 115-3.5	115,00	122,00	3,50	.*	OR 127-4	127,00	135,00	4,00	.*
OR 115-4	115,00	123,00	4,00	.*	OR 127-5.34	127,00	137,68	5,34	.*
OR 115-4.5	115,00	124,00	4,50	.*	OR 128-2.5	128,00	133,00	2,50	.*
OR 115-5	115,00	125,00	5,00	.*	OR 128-3	128,00	134,00	3,00	.*
OR 115-6	115,00	127,00	6,00	.*	OR 128-3.5	128,00	135,00	3,50	.*
OR 115-7	115,00	129,00	7,00	.*	OR 128-4	128,00	136,00	4,00	.*
OR 115-9	115,00	133,00	9,00	.*	OR 128-6	128,00	140,00	6,00	.*
OR 116-3	116,00	122,00	3,00	.*	OR 129-3	129,00	135,00	3,00	.*
OR 116-4	116,00	124,00	4,00	.*	OR 129-4	129,00	137,00	4,00	.*
OR 116-5	116,00	126,00	5,00	.*	OR 129-5.5	129,00	140,00	5,50	.*
OR 116.84-5.34	116,84	127,52	5,34	.*	OR 129.2-5.7	129,20	140,60	5,70	.*
OR 116.84-6.99	116,84	130,82	6,99	.*	OR 129.3-5.7	129,30	140,70	5,70	.*
OR 116.84-7	116,84	130,84	7,00	.*	OR 129.4-1.78	129,40	132,96	1,78	.*
OR 117-3	117,00	123,00	3,00	.*	OR 129.5-3	129,50	135,50	3,00	.*
OR 117-4	117,00	125,00	4,00	.*	OR 129.54-5.34	129,54	140,22	5,34	.*
OR 117.07-3.53	117,07	124,13	3,53	.*	OR 129.54-6.99	129,54	143,52	6,99	.*
OR 117.1-1.78	117,10	120,66	1,78	.*	OR 129.54-7	129,54	143,54	7,00	.*
OR 117.48-5.34	117,48	128,16	5,34	.*	OR 129.77-3.53	129,77	136,83	3,53	.*
OR 118-2.5	118,00	123,00	2,50	.*	OR 130-2	130,00	134,00	2,00	.*
OR 118-3	118,00	124,00	3,00	.*	OR 130-2.5	130,00	135,00	2,50	.*
OR 118-4	118,00	126,00	4,00	.*	OR 130-3	130,00	136,00	3,00	.*
OR 118-4.5	118,00	127,00	4,50	.*	OR 130-3.5	130,00	137,00	3,50	.*
OR 118-5	118,00	128,00	5,00	.*	OR 130-4	130,00	138,00	4,00	.*
OR 118-6	118,00	130,00	6,00	.*	OR 130-5	130,00	140,00	5,00	.*
OR 119-3	119,00	125,00	3,00	.*	OR 130-6	130,00	142,00	6,00	.*
OR 119-4	119,00	127,00	4,00	.*	OR 130.18-5.34	130,18	140,86	5,34	.*
OR 119.2-5.7	119,20	130,60	5,70	.*	OR 131-3	131,00	137,00	3,00	.*
OR 119.3-5.7	119,30	130,70	5,70	.*	OR 131-4	131,00	139,00	4,00	.*
OR 119.5-3	119,50	125,50	3,00	.*	OR 132-2	132,00	136,00	2,00	.*
OR 120-2	120,00	124,00	2,00	.*	OR 132-2.5	132,00	137,00	2,50	.*
OR 120-3	120,00	126,00	3,00	.*	OR 132-3	132,00	138,00	3,00	.*
OR 120-3.5	120,00	127,00	3,50	.*	OR 132-4	132,00	140,00	4,00	.*
OR 120-4	120,00	128,00	4,00	.*	OR 132-6	132,00	144,00	6,00	.*
OR 120-5	120,00	130,00	5,00	.*	OR 132.72-5.34	132,72	143,40	5,34	.*
OR 120-6	120,00	132,00	6,00	.*	OR 132.72-7	132,72	146,72	7,00	.*
OR 120-7	120,00	134,00	7,00	.*	OR 132.94-3.53	132,94	140,00	3,53	.*
OR 120-10	120,00	140,00	10,00	.*	OR 133-3	133,00	139,00	3,00	.*
OR 120.02-5.34	120,02	130,70	5,34	.*	OR 133-4	133,00	141,00	4,00	.*
OR 120.02-6.99	120,02	134,00	6,99	.*	OR 133-4.4	133,00	141,80	4,40	.*
OR 120.02-7	120,02	134,02	7,00	.*	OR 133.02-2.62	133,02	138,26	2,62	.*
OR 120.2-5.33	120,20	130,86	5,33	.*	OR 133.07-1.78	133,07	136,63	1,78	.*
OR 120.25-3.53	120,25	127,31	3,53	.*	OR 133.35-5.34	133,35	144,03	5,34	.*
OR 120.32-2.62	120,32	125,56	2,62	.*	OR 134-3	134,00	140,00	3,00	.*
OR 120.37-1.78	120,37	123,93	1,78	.*	OR 134-4	134,00	142,00	4,00	.*
OR 120.65-5.34	120,65	131,33	5,34	.*	OR 134-6	134,00	146,00	6,00	.*
OR 121-2.5	121,00	126,00	2,50	.*	OR 134.3-5.7	134,30	145,70	5,70	.*
OR 121-3	121,00	127,00	3,00	.*	OR 134.5-3	134,50	140,50	3,00	.*
OR 121-4	121,00	129,00	4,00	.*	OR 134.5-7	134,50	148,50	7,00	.*
OR 122-2.5	122,00	127,00	2,50	.*	OR 135-2	135,00	139,00	2,00	.*
OR 122-3	122,00	128,00	3,00	.*	OR 135-2.5	135,00	140,00	2,50	.*
OR 122-4	122,00	130,00	4,00	.*	OR 135-3	135,00	141,00	3,00	.*
OR 122-5	122,00	132,00	5,00	.*	OR 135-3.5	135,00	142,00	3,50	.*
OR 122-6	122,00	134,00	6,00	.*	OR 135-4	135,00	143,00	4,00	.*
OR 123-2	123,00	127,00	2,00	.*	OR 135-5	135,00	145,00	5,00	.*
OR 123-2.5	123,00	128,00	2,50	.*	OR 135-6	135,00	147,00	6,00	.*
OR 123-3	123,00	129,00	3,00	.*	OR 135.7-3.53	135,70	142,76	3,53	.*
OR 123-4	123,00	131,00	4,00	.*	OR 135.89-5.34	135,89	146,57	5,34	.*
OR 123-6	123,00	135,00	6,00	.*	OR 135.89-7	135,89	149,89	7,00	.*
OR 123-6.5	123,00	136,00	6,50	.*	OR 135.9-6.99	135,90	149,88	6,99	.*
OR 123.19-5.34	123,19	133,87	5,34	.*	OR 136-3	136,00	142,00	3,00	.*
OR 123.19-7	123,19	137,19	7,00	.*	OR 136-3.5	136,00	143,00	3,50	.*
OR 123.42-3.53	123,42	130,48	3,53	.*	OR 136-4	136,00	144,00	4,00	.*
OR 123.44-1.78	123,44	127,00	1,78	.*	OR 136-6	136,00	148,00	6,00	.*
OR 123.83-5.34	123,83	134,51	5,34	.*	OR 136.12-3.53	136,12	143,18	3,53	.*
OR 124-3	124,00	130,00	3,00	.*	OR 136.53-5.34	136,53	147,21	5,34	.*
OR 124-4	124,00	132,00	4,00	.*	OR 137-3	137,00	143,00	3,00	.*
OR 124-5.4	124,00	134,80	5,40	.*	OR 137-4	137,00	145,00	4,00	.*
OR 124-6	124,00	136,00	6,00	.*	OR 138-3	138,00	144,00	3,00	.*
OR 124.3-5.7	124,30	135,70	5,70	.*	OR 138-4	138,00	146,00	4,00	.*
OR 124.5-3	124,50	130,50	3,00	.*	OR 138-5	138,00	148,00	5,00	.*
OR 124.6-7	124,60	138,60	7,00	.*	OR 138-6	138,00	150,00	6,00	.*
OR 125-2	125,00	129,00	2,00	.*	OR 139-3	139,00	145,00	3,00	.*
OR 125-2.5	125,00	130,00	2,50	.*	OR 139-4	139,00	147,00	4,00	.*
OR 125-3	125,00	131,00	3,00	.*	OR 139.07-5.33	139,07	149,73	5,33	.*
OR 125-3.5	125,00	132,00	3,50	.*	OR 139.07-5.34	139,07	149,75	5,34	.*
OR 125-4	125,00	133,00	4,00	.*	OR 139.07-7	139,07	153,07	7,00	.*
OR 125-5	125,00	135,00	5,00	.*	OR 139.2-6	139,20	151,20	6,00	.*
OR 125-6	125,00	137,00	6,00	.*	OR 139.29-3.53	139,29	146,35	3,53	.*
OR 126-3	126,00	132,00	3,00	.*	OR 139.3-5.7	139,30	150,70	5,70	.*
OR 126-3.5	126,00	133,00	3,50	.*	OR 139.37-2.62	139,37	144,61	2,62	.*
OR 126-4	126,00	134,00	4,00	.*	OR 139.5-3	139,50	145,50	3,00	.*

Packaging unit: .\* upon request

Packaging unit: .\* upon request

Web: <http://cat.hansa-flex.com/en/OR70SHORENBR>

## OR 70° Shore NBR

(Continued)

## O-ring, 70SH NBR

Identification	d1 mm	d2 mm	s mm	Packaging unit
OR 139.6-5.7	139,60	151,00	5,70	-*
OR 140-2	140,00	144,00	2,00	-*
OR 140-2.5	140,00	145,00	2,50	-*
OR 140-3	140,00	146,00	3,00	-*
OR 140-4	140,00	148,00	4,00	-*
OR 140-5	140,00	150,00	5,00	-*
OR 140-6	140,00	152,00	6,00	-*
OR 140-8	140,00	156,00	8,00	-*
OR 141-3	141,00	147,00	3,00	-*
OR 141-4	141,00	149,00	4,00	-*
OR 142-3	142,00	148,00	3,00	-*
OR 142-4	142,00	150,00	4,00	-*
OR 142-5	142,00	152,00	5,00	-*
OR 142-6	142,00	154,00	6,00	-*
OR 142.24-5.34	142,24	152,92	5,34	-*
OR 142.24-7	142,24	156,24	7,00	-*
OR 142.47-3.53	142,47	149,53	3,53	-*
OR 142.88-5.34	142,88	153,56	5,34	-*
OR 143-2.5	143,00	148,00	2,50	-*
OR 143-3	143,00	149,00	3,00	-*
OR 143-4	143,00	151,00	4,00	-*
OR 144-3	144,00	150,00	3,00	-*
OR 144-4	144,00	152,00	4,00	-*
OR 144.1-8.4	144,10	160,90	8,40	-*
OR 144.2-5.7	144,20	155,60	5,70	-*
OR 144.3-5.7	144,30	155,70	5,70	-*
OR 144.5-3	144,50	150,50	3,00	-*
OR 145-2.5	145,00	150,00	2,50	-*
OR 145-3	145,00	151,00	3,00	-*
OR 145-3.5	145,00	152,00	3,50	-*
OR 145-4	145,00	153,00	4,00	-*
OR 145-5	145,00	155,00	5,00	-*
OR 145-6	145,00	157,00	6,00	-*
OR 145.42-5.33	145,42	156,08	5,33	-*
OR 145.42-5.34	145,42	156,10	5,34	-*
OR 145.42-6.99	145,42	159,40	6,99	-*
OR 145.42-7	145,42	159,42	7,00	-*
OR 145.64-3.53	145,64	152,70	3,53	-*
OR 145.72-2.62	145,72	150,96	2,62	-*
OR 146-2.5	146,00	151,00	2,50	-*
OR 146-3	146,00	152,00	3,00	-*
OR 146-4	146,00	154,00	4,00	-*
OR 146-5	146,00	156,00	5,00	-*
OR 146-6	146,00	158,00	6,00	-*
OR 146.05-5.34	146,05	156,73	5,34	-*
OR 147-3	147,00	153,00	3,00	-*
OR 147-4	147,00	155,00	4,00	-*
OR 148-3	148,00	154,00	3,00	-*
OR 148-4	148,00	156,00	4,00	-*
OR 148-5	148,00	158,00	5,00	-*
OR 148-6	148,00	160,00	6,00	-*
OR 148.59-5.34	148,59	159,27	5,34	-*
OR 148.59-7	148,59	162,59	7,00	-*
OR 148.82-3.53	148,82	155,88	3,53	-*
OR 149-3	149,00	155,00	3,00	-*
OR 149-4	149,00	157,00	4,00	-*
OR 149.1-8.4	149,10	165,90	8,40	-*
OR 149.2-5.7	149,20	160,60	5,70	-*
OR 149.23-5.34	149,23	159,91	5,34	-*
OR 149.3-5.7	149,30	160,70	5,70	-*
OR 149.5-3	149,50	155,50	3,00	-*
OR 150-3	150,00	156,00	3,00	-*
OR 150-4	150,00	158,00	4,00	-*
OR 150-5	150,00	160,00	5,00	-*
OR 150-6	150,00	162,00	6,00	-*
OR 151-3	151,00	157,00	3,00	-*
OR 151-4	151,00	159,00	4,00	-*
OR 151.77-5.33	151,77	162,43	5,33	-*
OR 151.77-5.34	151,77	162,45	5,34	-*
OR 151.77-7	151,77	165,77	7,00	-*
OR 151.99-3.53	151,99	159,05	3,53	-*
OR 152-3	152,00	158,00	3,00	-*
OR 152-4	152,00	160,00	4,00	-*
OR 152.07-2.62	152,07	157,31	2,62	-*
OR 153-3	153,00	159,00	3,00	-*
OR 153-4	153,00	161,00	4,00	-*
OR 153-5	153,00	163,00	5,00	-*
OR 153-6	153,00	165,00	6,00	-*
OR 154-3	154,00	160,00	3,00	-*
OR 154-4	154,00	162,00	4,00	-*
OR 154-5	154,00	164,00	5,00	-*
OR 154-6	154,00	166,00	6,00	-*
OR 154.1-8.4	154,10	170,90	8,40	-*
OR 154.3-5.7	154,30	165,70	5,70	-*
OR 154.5-3	154,50	160,50	3,00	-*
OR 155-3	155,00	161,00	3,00	-*
OR 155-4	155,00	163,00	4,00	-*
OR 155-5	155,00	165,00	5,00	-*

Packaging unit: -\* upon request

Identification	d1 mm	d2 mm	s mm	Packaging unit
OR 155-5.34	155,00	165,68	5,34	-*
OR 155-6	155,00	167,00	6,00	-*
OR 155.5-6	155,50	167,50	6,00	-*
OR 155.6-7	155,60	169,60	7,00	-*
OR 156-3	156,00	162,00	3,00	-*
OR 156-4	156,00	164,00	4,00	-*
OR 156-6	156,00	168,00	6,00	-*
OR 157-3	157,00	163,00	3,00	-*
OR 157-4	157,00	165,00	4,00	-*
OR 157-6	157,00	169,00	6,00	-*
OR 158-3	158,00	164,00	3,00	-*
OR 158-3.5	158,00	165,00	3,50	-*
OR 158-4	158,00	166,00	4,00	-*
OR 158-5	158,00	168,00	5,00	-*
OR 158-6	158,00	170,00	6,00	-*
OR 158.12-5.34	158,12	168,80	5,34	-*
OR 158.12-7	158,12	172,12	7,00	-*
OR 158.34-3.53	158,34	165,40	3,53	-*
OR 158.35-3.53	158,35	165,41	3,53	-*
OR 158.42-2.62	158,42	163,66	2,62	-*
OR 159-3	159,00	165,00	3,00	-*
OR 159-4	159,00	167,00	4,00	-*
OR 159-6	159,00	171,00	6,00	-*
OR 159.1-8.4	159,10	175,90	8,40	-*
OR 159.3-5.7	159,30	170,70	5,70	-*
OR 159.5-3	159,50	165,50	3,00	-*
OR 159.5-7	159,50	173,50	7,00	-*
OR 160-2	160,00	164,00	2,00	-*
OR 160-2.3	160,00	164,60	2,30	-*
OR 160-3	160,00	166,00	3,00	-*
OR 160-4	160,00	168,00	4,00	-*
OR 160-5	160,00	170,00	5,00	-*
OR 160-5.7	160,00	171,40	5,70	-*
OR 160-6	160,00	172,00	6,00	-*
OR 161-3	161,00	167,00	3,00	-*
OR 161.3-5.34	161,30	171,98	5,34	-*
OR 161.9-7	161,90	175,90	7,00	-*
OR 162-3	162,00	168,00	3,00	-*
OR 162-4	162,00	170,00	4,00	-*
OR 162-5	162,00	172,00	5,00	-*
OR 162-6	162,00	174,00	6,00	-*
OR 164-2.5	164,00	169,00	2,50	-*
OR 164-4	164,00	172,00	4,00	-*
OR 164.1-8.4	164,10	180,90	8,40	-*
OR 164.3-5.7	164,30	175,70	5,70	-*
OR 164.47-5.34	164,47	175,15	5,34	-*
OR 164.47-7	164,47	178,47	7,00	-*
OR 164.5-3	164,50	170,50	3,00	-*
OR 164.69-3.53	164,69	171,75	3,53	-*
OR 164.77-2.62	164,77	170,01	2,62	-*
OR 165-3	165,00	171,00	3,00	-*
OR 165-3.5	165,00	172,00	3,50	-*
OR 165-4	165,00	173,00	4,00	-*
OR 165-5	165,00	175,00	5,00	-*
OR 165-6	165,00	177,00	6,00	-*
OR 165-7	165,00	179,00	7,00	-*
OR 166-6	166,00	178,00	6,00	-*
OR 166.7-7	166,70	180,70	7,00	-*
OR 167-4	167,00	175,00	4,00	-*
OR 167.7-5.34	167,70	178,38	5,34	-*
OR 168-3	168,00	174,00	3,00	-*
OR 168-5	168,00	178,00	5,00	-*
OR 168.3-7	168,30	182,30	7,00	-*
OR 169-6	169,00	181,00	6,00	-*
OR 169.1-8.4	169,10	185,90	8,40	-*
OR 169.2-5.7	169,20	180,60	5,70	-*
OR 169.3-5.7	169,30	180,70	5,70	-*
OR 169.5-3	169,50	175,50	3,00	-*
OR 170-3	170,00	176,00	3,00	-*
OR 170-3.5	170,00	177,00	3,50	-*
OR 170-4	170,00	178,00	4,00	-*
OR 170-5	170,00	180,00	5,00	-*
OR 170-6	170,00	182,00	6,00	-*
OR 170.82-5.34	170,82	181,50	5,34	-*
OR 170.82-7	170,82	184,82	7,00	-*
OR 171.04-3.53	171,04	178,10	3,53	-*
OR 171.05-3.53	171,05	178,11	3,53	-*
OR 171.12-2.62	171,12	176,36	2,62	-*
OR 171.4-3.2	171,40	177,80	3,20	-*
OR 172-4	172,00	180,00	4,00	-*
OR 172-6	172,00	184,00	6,00	-*
OR 173-3	173,00	179,00	3,00	-*
OR 173-7	173,00	187,00	7,00	-*
OR 174-3	174,00	180,00	3,00	-*
OR 174-4	174,00	182,00	4,00	-*
OR 174-5	174,00	184,00	5,00	-*
OR 174-5.34	174,00	184,68	5,34	-*
OR 174.1-8.4	174,10	190,90	8,40	-*

Packaging unit: -\* upon request

Web: <http://cat.hansa-flex.com/en/OR70SHORENBR>

(Continued)

OR 70° Shore NBR

O-ring, 70SH NBR

Identification	d1 mm	d2 mm	s mm	Packaging unit
OR 174.3-5.7	174,30	185,70	5,70	.*
OR 174.6-7	174,60	188,60	7,00	.*
OR 175-3	175,00	181,00	3,00	.*
OR 175-4	175,00	183,00	4,00	.*
OR 175-5	175,00	185,00	5,00	.*
OR 175-6	175,00	187,00	6,00	.*
OR 175-7	175,00	189,00	7,00	.*
OR 176-6	176,00	188,00	6,00	.*
OR 177.17-5.34	177,17	187,85	5,34	.*
OR 177.17-6.99	177,17	191,15	6,99	.*
OR 177.17-7	177,17	191,17	7,00	.*
OR 177.4-3.53	177,40	184,46	3,53	.*
OR 177.47-2.62	177,47	182,71	2,62	.*
OR 179.1-8.4	179,10	195,90	8,40	.*
OR 179.3-5.7	179,30	190,70	5,70	.*
OR 179.5-3	179,50	185,50	3,00	.*
OR 180-3	180,00	186,00	3,00	.*
OR 180-3.5	180,00	187,00	3,50	.*
OR 180-4	180,00	188,00	4,00	.*
OR 180-5	180,00	190,00	5,00	.*
OR 180-6	180,00	192,00	6,00	.*
OR 181-7	181,00	195,00	7,00	.*
OR 182-3	182,00	188,00	3,00	.*
OR 182-6	182,00	194,00	6,00	.*
OR 183-3	183,00	189,00	3,00	.*
OR 183.52-5.34	183,52	194,20	5,34	.*
OR 183.52-7	183,52	197,52	7,00	.*
OR 183.74-3.53	183,74	190,80	3,53	.*
OR 183.82-2.62	183,82	189,06	2,62	.*
OR 184-3	184,00	190,00	3,00	.*
OR 184-6	184,00	196,00	6,00	.*
OR 184.1-8.4	184,10	200,90	8,40	.*
OR 184.3-5.7	184,30	195,70	5,70	.*
OR 185-3	185,00	191,00	3,00	.*
OR 185-3.5	185,00	192,00	3,50	.*
OR 185-4	185,00	193,00	4,00	.*
OR 185-5	185,00	195,00	5,00	.*
OR 185-6	185,00	197,00	6,00	.*
OR 186-4	186,00	194,00	4,00	.*
OR 186-7	186,00	200,00	7,00	.*
OR 187.3-7	187,30	201,30	7,00	.*
OR 188-4	188,00	196,00	4,00	.*
OR 188-6	188,00	200,00	6,00	.*
OR 189.1-8.4	189,10	205,90	8,40	.*
OR 189.3-5.7	189,30	200,70	5,70	.*
OR 189.87-5.34	189,87	200,55	5,34	.*
OR 189.87-6.99	189,87	203,85	6,99	.*
OR 189.87-7	189,87	203,87	7,00	.*
OR 190-3	190,00	196,00	3,00	.*
OR 190-4	190,00	198,00	4,00	.*
OR 190-4.5	190,00	199,00	4,50	.*
OR 190-5	190,00	200,00	5,00	.*
OR 190-6	190,00	202,00	6,00	.*
OR 190.09-3.53	190,09	197,15	3,53	.*
OR 190.17-2.62	190,17	195,41	2,62	.*
OR 192-4	192,00	200,00	4,00	.*
OR 192-5	192,00	202,00	5,00	.*
OR 193-6	193,00	205,00	6,00	.*
OR 193.7-6.99	193,70	207,68	6,99	.*
OR 193.7-7	193,70	207,70	7,00	.*
OR 194-2	194,00	198,00	2,00	.*
OR 194.1-8.4	194,10	210,90	8,40	.*
OR 194.3-5.7	194,30	205,70	5,70	.*
OR 195-2.5	195,00	200,00	2,50	.*
OR 195-3	195,00	201,00	3,00	.*
OR 195-3.5	195,00	202,00	3,50	.*
OR 195-4	195,00	203,00	4,00	.*
OR 195-5	195,00	205,00	5,00	.*
OR 195-6	195,00	207,00	6,00	.*
OR 195-7	195,00	209,00	7,00	.*
OR 195-7.5	195,00	210,00	7,50	.*
OR 196-6	196,00	208,00	6,00	.*
OR 196.22-5.34	196,22	206,90	5,34	.*
OR 196.22-7	196,22	210,22	7,00	.*
OR 196.44-3.53	196,44	203,50	3,53	.*
OR 196.52-2.62	196,52	201,76	2,62	.*
OR 197-3	197,00	203,00	3,00	.*
OR 198-6	198,00	210,00	6,00	.*
OR 199-3	199,00	205,00	3,00	.*
OR 199.1-8.4	199,10	215,90	8,40	.*
OR 199.3-3	199,30	205,30	3,00	.*
OR 199.3-5.7	199,30	210,70	5,70	.*
OR 200-3	200,00	206,00	3,00	.*
OR 200-4	200,00	208,00	4,00	.*
OR 200-5	200,00	210,00	5,00	.*
OR 200-6	200,00	212,00	6,00	.*
OR 200-7	200,00	214,00	7,00	.*
OR 200-8	200,00	216,00	8,00	.*

Packaging unit: .\* upon request

Identification	d1 mm	d2 mm	s mm	Packaging unit
OR 200-10	200,00	220,00	10,00	.*
OR 202.57-5.34	202,57	213,25	5,34	.*
OR 202.57-7	202,57	216,57	7,00	.*
OR 202.79-3.53	202,79	209,85	3,53	.*
OR 202.87-2.62	202,87	208,11	2,62	.*
OR 204.1-8.4	204,10	220,90	8,40	.*
OR 204.2-5.7	204,20	215,60	5,70	.*
OR 205-3	205,00	211,00	3,00	.*
OR 205-4	205,00	213,00	4,00	.*
OR 205-5	205,00	215,00	5,00	.*
OR 205-6	205,00	217,00	6,00	.*
OR 206-4	206,00	214,00	4,00	.*
OR 206-7	206,00	220,00	7,00	.*
OR 208-6	208,00	220,00	6,00	.*
OR 208.92-5.34	208,92	219,60	5,34	.*
OR 208.92-7	208,92	222,92	7,00	.*
OR 209.1-8.4	209,10	225,90	8,40	.*
OR 209.14-3.53	209,14	216,20	3,53	.*
OR 209.22-2.62	209,22	214,46	2,62	.*
OR 209.3-5.7	209,30	220,70	5,70	.*
OR 210-3	210,00	216,00	3,00	.*
OR 210-4	210,00	218,00	4,00	.*
OR 210-5	210,00	220,00	5,00	.*
OR 210-6	210,00	222,00	6,00	.*
OR 210-7	210,00	224,00	7,00	.*
OR 210-8	210,00	226,00	8,00	.*
OR 212-6	212,00	224,00	6,00	.*
OR 212-7	212,00	226,00	7,00	.*
OR 215-3	215,00	221,00	3,00	.*
OR 215-4	215,00	223,00	4,00	.*
OR 215-5	215,00	225,00	5,00	.*
OR 215-6	215,00	227,00	6,00	.*
OR 215.27-5.34	215,27	225,95	5,34	.*
OR 215.27-7	215,27	229,27	7,00	.*
OR 215.49-3.53	215,49	222,55	3,53	.*
OR 215.57-2.62	215,57	220,81	2,62	.*
OR 217-5	217,00	227,00	5,00	.*
OR 218-7	218,00	232,00	7,00	.*
OR 219.1-8.4	219,10	235,90	8,40	.*
OR 219.3-5.7	219,30	230,70	5,70	.*
OR 220-3	220,00	226,00	3,00	.*
OR 220-4	220,00	228,00	4,00	.*
OR 220-5	220,00	230,00	5,00	.*
OR 220-6	220,00	232,00	6,00	.*
OR 221.62-5.34	221,62	232,30	5,34	.*
OR 221.62-7	221,62	235,62	7,00	.*
OR 221.84-3.53	221,84	228,90	3,53	.*
OR 221.92-2.62	221,92	227,16	2,62	.*
OR 222-4	222,00	230,00	4,00	.*
OR 224-3.5	224,00	231,00	3,50	.*
OR 224-7	224,00	238,00	7,00	.*
OR 225-3	225,00	231,00	3,00	.*
OR 225-4	225,00	233,00	4,00	.*
OR 225-5	225,00	235,00	5,00	.*
OR 225-6	225,00	237,00	6,00	.*
OR 226-5	226,00	236,00	5,00	.*
OR 227.97-5.34	227,97	238,65	5,34	.*
OR 227.97-6.99	227,97	241,95	6,99	.*
OR 227.97-7	227,97	241,97	7,00	.*
OR 228.19-3.53	228,19	235,25	3,53	.*
OR 228.27-2.62	228,27	233,51	2,62	.*
OR 229.1-8.4	229,10	245,90	8,40	.*
OR 229.3-5.7	229,30	240,70	5,70	.*
OR 230-3	230,00	236,00	3,00	.*
OR 230-4	230,00	238,00	4,00	.*
OR 230-5	230,00	240,00	5,00	.*
OR 230-6	230,00	242,00	6,00	.*
OR 230-7	230,00	244,00	7,00	.*
OR 234.1-8.4	234,10	250,90	8,40	.*
OR 234.32-5.33	234,32	244,98	5,33	.*
OR 234.32-5.34	234,32	245,00	5,34	.*
OR 234.32-7	234,32	248,32	7,00	.*
OR 234.54-3.53	234,54	241,60	3,53	.*
OR 234.62-2.62	234,62	239,86	2,62	.*
OR 235-3	235,00	241,00	3,00	.*
OR 235-4	235,00	243,00	4,00	.*
OR 235-5	235,00	245,00	5,00	.*
OR 235-6	235,00	247,00	6,00	.*
OR 236-7	236,00	250,00	7,00	.*
OR 238-4	238,00	246,00	4,00	.*
OR 238-6	238,00	250,00	6,00	.*
OR 239.1-8.4	239,10	255,90	8,40	.*
OR 239.3-5.7	239,30	250,70	5,70	.*
OR 240-3	240,00	246,00	3,00	.*
OR 240-4	240,00	248,00	4,00	.*
OR 240-5	240,00	250,00	5,00	.*
OR 240-6	240,00	252,00	6,00	.*
OR 240.67-5.34	240,67	251,35	5,34	.*

Packaging unit: .\* upon request

Web: <http://cat.hansa-flex.com/en/OR70SHORENBR>

**OR 70° Shore NBR**

(Continued)

**O-ring, 70SH NBR**

Identification	d1 mm	d2 mm	s mm	Packaging unit
OR 240.67-7	240,67	254,67	7,00	-*
OR 240.89-3.53	240,89	247,95	3,53	-*
OR 240.97-2.62	240,97	246,21	2,62	-*
OR 242-5	242,00	252,00	5,00	-*
OR 243-7	243,00	257,00	7,00	-*
OR 245-3	245,00	251,00	3,00	-*
OR 245-4	245,00	253,00	4,00	-*
OR 245-5	245,00	255,00	5,00	-*
OR 247-6	247,00	259,00	6,00	-*
OR 247-7	247,00	261,00	7,00	-*
OR 247.02-5.34	247,02	257,70	5,34	-*
OR 247.26-3.53	247,26	254,32	3,53	-*
OR 247.32-2.62	247,32	252,56	2,62	-*
OR 249.1-8.4	249,10	265,90	8,40	-*
OR 249.3-5.7	249,30	260,70	5,70	-*
OR 250-3	250,00	256,00	3,00	-*
OR 250-4	250,00	258,00	4,00	-*
OR 250-5	250,00	260,00	5,00	-*
OR 250-6	250,00	262,00	6,00	-*
OR 250-7	250,00	264,00	7,00	-*
OR 250-8	250,00	266,00	8,00	-*
OR 253.37-5.34	253,37	264,05	5,34	-*
OR 253.37-7	253,37	267,37	7,00	-*
OR 253.59-3.53	253,59	260,65	3,53	-*
OR 255-4	255,00	263,00	4,00	-*
OR 255-5	255,00	265,00	5,00	-*
OR 258-7	258,00	272,00	7,00	-*
OR 258-8	258,00	274,00	8,00	-*
OR 259.3-5.7	259,30	270,70	5,70	-*
OR 259.7-7	259,70	273,70	7,00	-*
OR 260-4	260,00	268,00	4,00	-*
OR 260-5	260,00	270,00	5,00	-*
OR 260-6	260,00	272,00	6,00	-*
OR 263-5	263,00	273,00	5,00	-*
OR 264-4	264,00	272,00	4,00	-*
OR 265-4	265,00	273,00	4,00	-*
OR 265-6	265,00	277,00	6,00	-*
OR 265-7	265,00	279,00	7,00	-*
OR 266.07-5.34	266,07	276,75	5,34	-*
OR 266.07-7	266,07	280,07	7,00	-*
OR 266.29-3.53	266,29	273,35	3,53	-*
OR 269.3-5.7	269,30	280,70	5,70	-*
OR 270-3	270,00	276,00	3,00	-*
OR 270-4	270,00	278,00	4,00	-*
OR 270-5	270,00	280,00	5,00	-*
OR 270-6	270,00	282,00	6,00	-*
OR 272.4-7	272,40	286,40	7,00	-*
OR 275-4	275,00	283,00	4,00	-*
OR 278.77-5.34	278,77	289,45	5,34	-*
OR 278.77-7	278,77	292,77	7,00	-*
OR 278.99-3.53	278,99	286,05	3,53	-*
OR 279.3-5.7	279,30	290,70	5,70	-*
OR 280-4	280,00	288,00	4,00	-*
OR 280-5	280,00	290,00	5,00	-*
OR 280-6	280,00	292,00	6,00	-*
OR 280-7	280,00	294,00	7,00	-*
OR 280-10	280,00	300,00	10,00	-*
OR 285-4	285,00	293,00	4,00	-*
OR 285-6	285,00	297,00	6,00	-*
OR 285.1-7	285,10	299,10	7,00	-*
OR 289.3-5.7	289,30	300,70	5,70	-*
OR 290-3	290,00	296,00	3,00	-*
OR 290-4	290,00	298,00	4,00	-*
OR 290-5	290,00	300,00	5,00	-*
OR 290-6	290,00	302,00	6,00	-*
OR 290-7	290,00	304,00	7,00	-*
OR 291.47-5.34	291,47	302,15	5,34	-*
OR 291.47-7	291,47	305,47	7,00	-*
OR 291.69-3.53	291,69	298,75	3,53	-*
OR 295-4	295,00	303,00	4,00	-*
OR 295-6	295,00	307,00	6,00	-*
OR 297.8-7	297,80	311,80	7,00	-*
OR 299.3-5.7	299,30	310,70	5,70	-*
OR 300-3	300,00	306,00	3,00	-*
OR 300-4	300,00	308,00	4,00	-*
OR 300-5	300,00	310,00	5,00	-*
OR 300-6	300,00	312,00	6,00	-*
OR 300-7	300,00	314,00	7,00	-*
OR 304.17-5.34	304,17	314,85	5,34	-*
OR 304.17-7	304,17	318,17	7,00	-*
OR 304.39-3.53	304,39	311,45	3,53	-*
OR 305-4	305,00	313,00	4,00	-*
OR 305-6	305,00	317,00	6,00	-*
OR 307-7	307,00	321,00	7,00	-*
OR 310-3	310,00	316,00	3,00	-*
OR 310-4	310,00	318,00	4,00	-*
OR 310-6	310,00	322,00	6,00	-*
OR 310.5-7	310,50	324,50	7,00	-*

Packaging unit: -\* upon request

Identification	d1 mm	d2 mm	s mm	Packaging unit
OR 315-4	315,00	323,00	4,00	-*
OR 315-6	315,00	327,00	6,00	-*
OR 315-7	315,00	329,00	7,00	-*
OR 316.87-7	316,87	330,87	7,00	-*
OR 319.3-5.7	319,30	330,70	5,70	-*
OR 320-4	320,00	328,00	4,00	-*
OR 320-5	320,00	330,00	5,00	-*
OR 320-6	320,00	332,00	6,00	-*
OR 320-8	320,00	336,00	8,00	-*
OR 323.2-7	323,20	337,20	7,00	-*
OR 325-4	325,00	333,00	4,00	-*
OR 325-6	325,00	337,00	6,00	-*
OR 325-7	325,00	339,00	7,00	-*
OR 329.3-5.7	329,30	340,70	5,70	-*
OR 329.57-5.34	329,57	340,25	5,34	-*
OR 329.57-6.99	329,57	343,55	6,99	-*
OR 329.57-7	329,57	343,57	7,00	-*
OR 329.79-3.53	329,79	336,85	3,53	-*
OR 330-4	330,00	338,00	4,00	-*
OR 330-5	330,00	340,00	5,00	-*
OR 330-6	330,00	342,00	6,00	-*
OR 335-4	335,00	343,00	4,00	-*
OR 335-6	335,00	347,00	6,00	-*
OR 335.9-7	335,90	349,90	7,00	-*
OR 339.3-5.7	339,30	350,70	5,70	-*
OR 340-4	340,00	348,00	4,00	-*
OR 340-6	340,00	352,00	6,00	-*
OR 342.27-7	342,27	356,27	7,00	-*
OR 345-4	345,00	353,00	4,00	-*
OR 345-6	345,00	357,00	6,00	-*
OR 345-7	345,00	359,00	7,00	-*
OR 345-10	345,00	365,00	10,00	-*
OR 350-4	350,00	358,00	4,00	-*
OR 350-5	350,00	360,00	5,00	-*
OR 350-6	350,00	362,00	6,00	-*
OR 354.97-5.34	354,97	365,65	5,34	-*
OR 354.97-7	354,97	368,97	7,00	-*
OR 355-4	355,00	363,00	4,00	-*
OR 355-5	355,00	365,00	5,00	-*
OR 355-6	355,00	367,00	6,00	-*
OR 355.19-3.53	355,19	362,25	3,53	-*
OR 359.3-5.7	359,30	370,70	5,70	-*
OR 360-4	360,00	368,00	4,00	-*
OR 360-6	360,00	372,00	6,00	-*
OR 365-4	365,00	373,00	4,00	-*
OR 365-6	365,00	377,00	6,00	-*
OR 365-7	365,00	379,00	7,00	-*
OR 366.54-3.53	366,54	373,60	3,53	-*
OR 367-3.5	367,00	374,00	3,50	-*
OR 367.67-7	367,67	381,67	7,00	-*
OR 368-5	368,00	378,00	5,00	-*
OR 370-4	370,00	378,00	4,00	-*
OR 370-5	370,00	380,00	5,00	-*
OR 370-6	370,00	382,00	6,00	-*
OR 375-4	375,00	383,00	4,00	-*
OR 375-6	375,00	387,00	6,00	-*
OR 375-7	375,00	389,00	7,00	-*
OR 379.3-5.7	379,30	390,70	5,70	-*
OR 380-4	380,00	388,00	4,00	-*
OR 380-5	380,00	390,00	5,00	-*
OR 380-6	380,00	392,00	6,00	-*
OR 380-8	380,00	396,00	8,00	-*
OR 380.37-5.34	380,37	391,05	5,34	-*
OR 380.37-7	380,37	394,37	7,00	-*
OR 380.59-3.53	380,59	387,65	3,53	-*
OR 385-4	385,00	393,00	4,00	-*
OR 385-6	385,00	397,00	6,00	-*
OR 386-6	386,00	398,00	6,00	-*
OR 387-7	387,00	401,00	7,00	-*
OR 390-4	390,00	398,00	4,00	-*
OR 390-5	390,00	400,00	5,00	-*
OR 390-6	390,00	402,00	6,00	-*
OR 393.07-7	393,07	407,07	7,00	-*
OR 395-4	395,00	403,00	4,00	-*
OR 395-6	395,00	407,00	6,00	-*
OR 395-7	395,00	409,00	7,00	-*
OR 399.3-5.7	399,30	410,70	5,70	-*
OR 400-4	400,00	408,00	4,00	-*
OR 400-6	400,00	412,00	6,00	-*
OR 400-7	400,00	414,00	7,00	-*
OR 405-4	405,00	413,00	4,00	-*
OR 405.26-3.53	405,26	412,32	3,53	-*
OR 405.26-5.34	405,26	415,94	5,34	-*
OR 405.26-7	405,26	419,26	7,00	-*
OR 410-4	410,00	418,00	4,00	-*
OR 410-5	410,00	420,00	5,00	-*
OR 412-7	412,00	426,00	7,00	-*
OR 415-4	415,00	423,00	4,00	-*

Packaging unit: -\* upon request

Web: <http://cat.hansa-flex.com/en/OR70SHORENBR>



(Continued)

OR 70° Shore NBR

O-ring, 70SH NBR

Identification	d1 mm	d2 mm	s mm	Packaging unit
OR 415-5	415,00	425,00	5,00	-*
OR 415-6	415,00	427,00	6,00	-*
OR 417.96-7	417,96	431,96	7,00	-*
OR 419.3-5.7	419,30	430,70	5,70	-*
OR 420-4	420,00	428,00	4,00	-*
OR 420-10	420,00	440,00	10,00	-*
OR 425-4	425,00	433,00	4,00	-*
OR 425-7	425,00	439,00	7,00	-*
OR 429-6	429,00	441,00	6,00	-*
OR 430-4	430,00	438,00	4,00	-*
OR 430.66-3.53	430,66	437,72	3,53	-*
OR 430.66-5.34	430,66	441,34	5,34	-*
OR 430.66-7	430,66	444,66	7,00	-*
OR 435-4	435,00	443,00	4,00	-*
OR 437-7	437,00	451,00	7,00	-*
OR 439.3-5.7	439,30	450,70	5,70	-*
OR 440-4	440,00	448,00	4,00	-*
OR 443.36-7	443,36	457,36	7,00	-*
OR 445-4	445,00	453,00	4,00	-*
OR 450-4	450,00	458,00	4,00	-*
OR 450-6	450,00	462,00	6,00	-*
OR 450-7	450,00	464,00	7,00	-*
OR 455-4	455,00	463,00	4,00	-*
OR 456.06-3.53	456,06	463,12	3,53	-*
OR 456.06-5.34	456,06	466,74	5,34	-*
OR 456.06-7	456,06	470,06	7,00	-*
OR 457.2-7	457,20	471,20	7,00	-*
OR 459.3-5.7	459,30	470,70	5,70	-*
OR 460-4	460,00	468,00	4,00	-*
OR 460-6	460,00	472,00	6,00	-*
OR 462-7	462,00	476,00	7,00	-*
OR 465-4	465,00	473,00	4,00	-*
OR 468.76-7	468,76	482,76	7,00	-*
OR 470-4	470,00	478,00	4,00	-*
OR 470-6	470,00	482,00	6,00	-*
OR 475-4	475,00	483,00	4,00	-*
OR 475-7	475,00	489,00	7,00	-*
OR 479.3-5.7	479,30	490,70	5,70	-*
OR 480-4	480,00	488,00	4,00	-*
OR 480-6	480,00	492,00	6,00	-*
OR 481.41-5.34	481,41	492,09	5,34	-*
OR 481.46-7	481,46	495,46	7,00	-*
OR 485-4	485,00	493,00	4,00	-*
OR 486-6	486,00	498,00	6,00	-*
OR 487-7	487,00	501,00	7,00	-*

Packaging unit: -\* upon request

Web: <http://cat.hansa-flex.com/en/OR70SHORENBR>

Identification	d1 mm	d2 mm	s mm	Packaging unit
OR 489-6	489,00	501,00	6,00	-*
OR 490-4	490,00	498,00	4,00	-*
OR 494.67-7	494,67	508,67	7,00	-*
OR 495-4	495,00	503,00	4,00	-*
OR 499.3-5.7	499,30	510,70	5,70	-*
OR 500-6	500,00	512,00	6,00	-*
OR 500-7	500,00	514,00	7,00	-*
OR 505-6	505,00	517,00	6,00	-*
OR 506.81-5.34	506,81	517,49	5,34	-*
OR 506.86-7	506,86	520,86	7,00	-*
OR 510-6	510,00	522,00	6,00	-*
OR 515-7	515,00	529,00	7,00	-*
OR 516-6	516,00	528,00	6,00	-*
OR 530-6	530,00	542,00	6,00	-*
OR 530-7	530,00	544,00	7,00	-*
OR 532.21-5.34	532,21	542,89	5,34	-*
OR 532.26-7	532,26	546,26	7,00	-*
OR 540-6	540,00	552,00	6,00	-*
OR 540-8	540,00	556,00	8,00	-*
OR 545.47-7	545,47	559,47	7,00	-*
OR 555-6	555,00	567,00	6,00	-*
OR 557.61-5.34	557,61	568,29	5,34	-*
OR 557.66-7	557,66	571,66	7,00	-*
OR 560-5.33	560,00	570,66	5,33	-*
OR 560-6	560,00	572,00	6,00	-*
OR 560-7	560,00	574,00	7,00	-*
OR 579-6	579,00	591,00	6,00	-*
OR 580-7	580,00	594,00	7,00	-*
OR 580-9	580,00	598,00	9,00	-*
OR 582.68-5.34	582,68	593,36	5,34	-*
OR 582.68-7	582,68	596,68	7,00	-*
OR 596.27-7	596,27	610,27	7,00	-*
OR 600-7	600,00	614,00	7,00	-*
OR 608.08-5.34	608,08	618,76	5,34	-*
OR 608.08-7	608,08	622,08	7,00	-*
OR 615-7	615,00	629,00	7,00	-*
OR 630-7	630,00	644,00	7,00	-*
OR 633.48-5.34	633,48	644,16	5,34	-*
OR 633.48-7	633,48	647,48	7,00	-*
OR 647.07-7	647,07	661,07	7,00	-*
OR 649-8.4	649,00	665,80	8,40	-*
OR 650-7	650,00	664,00	7,00	-*
OR 658.88-5.34	658,88	669,56	5,34	-*
OR 658.88-7	658,88	672,88	7,00	-*
OR 670-7	670,00	684,00	7,00	-*

Packaging unit: -\* upon request

**OR 80° Shore NBR**

**O-ring 80SH NBR**

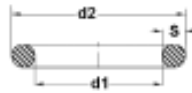

Bestellkennung / Item code  
OR 16.68-3.53 V  
d1 (mm) x 100      Werkstoff / Material  
G (mm) x 100

**Design:** O-ring  
**Temp. min.:** -30 °C  
**Temp. max.:** 110 °C  
**Material:** NBR 80 Shore

Identification	d1 mm	d2 mm	s mm
OR 5-1.5 N80	5,00	8,00	1,50
OR 8-1.9 N80	8,00	11,80	1,90
OR 8.73-1.78 N80	8,73	12,29	1,78
OR 12-2 N80	12,00	16,00	2,00
OR 12.42-1.78 N80	12,42	15,98	1,78
OR 13.94-2.62 N80	13,94	19,18	2,62
OR 14-2.5 N80	14,00	19,00	2,50
OR 16-3 N80	16,00	22,00	3,00
OR 18.3-3.6 N80	18,30	25,50	3,60
OR 19.8-3.6 N80	19,80	27,00	3,60
OR 21.3-3.6 N80	21,30	28,50	3,60
OR 21.89-2.62 N80	21,89	27,13	2,62
OR 23-2 N80	23,00	27,00	2,00
OR 23-3.6 N80	23,00	30,20	3,60
OR 24.6-3.6 N80	24,60	31,80	3,60
OR 25.12-1.78 N80	25,12	28,68	1,78
OR 26.2-3.6 N80	26,20	33,40	3,60
OR 27.8-3.6 N80	27,80	35,00	3,60
OR 28.17-3.53 N80	28,17	35,23	3,53
OR 29-3 N80	29,00	35,00	3,00
OR 29-3.5 N80	29,00	36,00	3,50
OR 29.3-3.6 N80	29,30	36,50	3,60
OR 31.42-2.62 N80	31,42	36,66	2,62
OR 32-3.5 N80	32,00	39,00	3,50
OR 32.5-3.6 N80	32,50	39,70	3,60
OR 34.1-3.6 N80	34,10	41,30	3,60
OR 34.59-2.62 N80	34,59	39,83	2,62
OR 35.6-3.6 N80	35,60	42,80	3,60
OR 37.3-3.6 N80	37,30	44,50	3,60
OR 39.5-2.5 N80	39,50	44,50	2,50
OR 40-3 N80	40,00	46,00	3,00
OR 40.64-5.34 N80	40,64	51,32	5,34
OR 42.86-3.53 N80	42,86	49,92	3,53
OR 46-3 N80	46,00	52,00	3,00
OR 49.2-3.53 N80	49,20	56,26	3,53
OR 50-3 N80	50,00	56,00	3,00
OR 50.17-5.34 N80	50,17	60,85	5,34
OR 53.57-3.53 N80	53,57	60,63	3,53
OR 55-3 N80	55,00	61,00	3,00
OR 55.25-2.62 N80	55,25	60,49	2,62

Identification	d1 mm	d2 mm	s mm
OR 58.74-3.53 N80	58,74	65,80	3,53
OR 60-3 N80	60,00	66,00	3,00
OR 63-3 N80	63,00	69,00	3,00
OR 65.1-3.53 N80	65,10	72,16	3,53
OR 67-3 N80	67,00	73,00	3,00
OR 68-6 N80	68,00	80,00	6,00
OR 69.44-3.53 N80	69,44	76,50	3,53
OR 72.62-3.53 N80	72,62	79,68	3,53
OR 75.79-3.53 N80	75,79	82,85	3,53
OR 81.92-5.34 N80	81,92	92,60	5,34
OR 88-6 N80	88,00	100,00	6,00
OR 89.69-5.34 N80	89,69	100,37	5,34
OR 97.79-5.34 N80	97,79	108,47	5,34
OR 107.54-3.53 N80	107,54	114,60	3,53
OR 113.89-3.53 N80	113,89	120,95	3,53
OR 116.84-5.34 N80	116,84	127,52	5,34
OR 117.07-3.53 N80	117,07	124,13	3,53
OR 126.37-5.34 N80	126,37	137,05	5,34
OR 126.37-7 N80	126,37	140,37	7,00
OR 132.72-7 N80	132,72	146,72	7,00
OR 133.35-5.34 N80	133,35	144,03	5,34
OR 139.07-7 N80	139,07	153,07	7,00
OR 139.29-3.53 N80	139,29	146,35	3,53
OR 142.24-5.34 N80	142,24	152,92	5,34
OR 142.24-7 N80	142,24	156,24	7,00
OR 145.42-5.34 N80	145,42	156,10	5,34
OR 148.82-3.53 N80	148,82	155,88	3,53
OR 151.77-5.34 N80	151,77	162,45	5,34
OR 151.77-7 N80	151,77	165,77	7,00
OR 158.12-7 N80	158,12	172,12	7,00
OR 164.47-5.34 N80	164,47	175,15	5,34
OR 170.82-5.34 N80	170,82	181,50	5,34
OR 177.17-7 N80	177,17	191,17	7,00
OR 183.52-5.34 N80	183,52	194,20	5,34
OR 189.87-5.34 N80	189,87	200,55	5,34
OR 190.09-3.53 N80	190,09	197,15	3,53
OR 202.57-7 N80	202,57	216,57	7,00
OR 240.67-7 N80	240,67	254,67	7,00
OR 291.47-7 N80	291,47	305,47	7,00

**Web:** <http://cat.hansa-flex.com/en/OR80SHORENBR>

**OR 90° Shore NBR NO**

**O-ring 90 SH NBR NO**

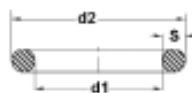

Bestellkennung / Item code  
OR 16.68-3.53 V  
d1 (mm) x 100      Werkstoff / Material  
G (mm) x 100

**Hardness:** DIN ISO 48 **Ozone resistance:** DIN 53509-1

**Design:** O-ring  
**Colour:** black  
**Temp. min.:** -20 °C  
**Temp. max.:** 100 °C  
**Material:** NBR 85 Shore A ozone resistant

Identification	d1 mm	d2 mm	s mm
OR 4-1.5 NO	4,00	7,00	1,50
OR 6-1.5 NO	6,00	9,00	1,50
OR 7.5-1.5 NO	7,50	10,50	1,50
OR 9-1.5 NO	9,00	12,00	1,50
OR 10-1.5 NO	10,00	13,00	1,50
OR 10-2 NO	10,00	14,00	2,00
OR 12-2 NO	12,00	16,00	2,00
OR 13-2 NO	13,00	17,00	2,00
OR 15-2 NO	15,00	19,00	2,00

Identification	d1 mm	d2 mm	s mm
OR 16-2.5 NO	16,00	21,00	2,50
OR 17.5-2.5 NO	17,50	23,50	2,50
OR 19-1.5 NO	19,00	22,00	1,50
OR 20-2 NO	20,00	24,00	2,00
OR 20-2.5 NO	20,00	25,00	2,50
OR 22-2.5 NO	22,00	27,00	2,50
OR 25-1.5 NO	25,00	28,00	1,50
OR 25-2.5 NO	25,00	30,00	2,50
OR 26-2 NO	26,00	30,00	2,00

(Continued)

OR 90° Shore NBR NO

O-ring 90 SH NBR NO

Identification	d1 mm	d2 mm	s mm
OR 27-2.5 NO	27,00	33,00	2,50
OR 32-2.5 NO	32,00	37,00	2,50

Identification	d1 mm	d2 mm	s mm
OR 33-2.5 NO	33,00	38,00	2,50
OR 38-2.5 NO	38,00	43,00	2,50

**Web:** <http://cat.hansa-flex.com/en/OR90SHORENBRNO>

**OR 90° Shore NBR**

**O-ring 90SH NBR**

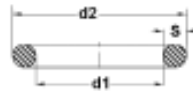

**Design:** O-ring  
**Temp. min.:** -30 °C  
**Temp. max.:** 110 °C  
**Material:** NBR 90 Shore

Identification	d1 mm	d2 mm	s mm	Identification	d1 mm	d2 mm	s mm
OR 1.78-1.78 N90	1,78	5,34	1,78	OR 15.1-2.7 N90	15,10	20,50	2,70
OR 2.4-1.9 N90	2,40	6,20	1,90	OR 15.47-3.53 N90	15,47	22,53	3,53
OR 2.57-1.78 N90	2,57	6,13	1,78	OR 15.54-2.62 N90	15,54	20,78	2,62
OR 2.6-1.9 N90	2,60	6,40	1,90	OR 15.6-1.78 N90	15,60	19,16	1,78
OR 2.8-1.5 N90	2,80	5,80	1,50	OR 15.88-2.62 N90	15,88	21,12	2,62
OR 2.9-1.78 N90	2,90	6,46	1,78	OR 16-2 N90	16,00	20,00	2,00
OR 3.17-1.78 N90	3,17	6,73	1,78	OR 16-3 N90	16,00	22,00	3,00
OR 3.68-1.78 N90	3,68	7,24	1,78	OR 16.3-2.4 N90	16,30	21,10	2,40
OR 4-2 N90	4,00	8,00	2,00	OR 16.9-2.7 N90	16,90	22,30	2,70
OR 4.47-1.78 N90	4,47	8,03	1,78	OR 17-1.5 N90	17,00	20,00	1,50
OR 4.76-1.78 N90	4,76	8,32	1,78	OR 17-2 N90	17,00	21,00	2,00
OR 4.9-1.9 N90	4,90	8,70	1,90	OR 17-2.5 N90	17,00	22,00	2,50
OR 5-1.5 N90	5,00	8,00	1,50	OR 17-3 N90	17,00	23,00	3,00
OR 5-2 N90	5,00	9,00	2,00	OR 17.04-3.53 N90	17,04	24,10	3,53
OR 5.28-1.78 N90	5,28	8,84	1,78	OR 17.12-2.62 N90	17,12	22,36	2,62
OR 5.7-1.9 N90	5,70	9,50	1,90	OR 17.17-1.78 N90	17,17	20,73	1,78
OR 6-2 N90	6,00	10,00	2,00	OR 17.3-2.4 N90	17,30	22,10	2,40
OR 6.07-1.78 N90	6,07	9,63	1,78	OR 17.86-2.62 N90	17,86	23,10	2,62
OR 6.35-1.78 N90	6,35	9,91	1,78	OR 18-2 N90	18,00	22,00	2,00
OR 6.4-1.9 N90	6,40	10,20	1,90	OR 18-2.5 N90	18,00	23,00	2,50
OR 6.75-1.78 N90	6,75	10,31	1,78	OR 18-3 N90	18,00	24,00	3,00
OR 7-1.5 N90	7,00	10,00	1,50	OR 18.3-2.4 N90	18,30	23,10	2,40
OR 7.2-1.9 N90	7,20	11,00	1,90	OR 18.3-3.6 N90	18,30	25,50	3,60
OR 7.59-2.62 N90	7,59	12,83	2,62	OR 18.4-2.7 N90	18,40	23,80	2,70
OR 7.65-1.78 N90	7,65	11,21	1,78	OR 18.5-2 N90	18,50	22,50	2,00
OR 7.94-1.78 N90	7,94	11,50	1,78	OR 18.64-3.53 N90	18,64	25,70	3,53
OR 8-1.9 N90	8,00	11,80	1,90	OR 18.72-2.62 N90	18,72	23,96	2,62
OR 8-2 N90	8,00	12,00	2,00	OR 18.77-1.78 N90	18,77	22,33	1,78
OR 8.3-2.4 N90	8,30	13,10	2,40	OR 19-3 N90	19,00	25,00	3,00
OR 8.73-1.78 N90	8,73	12,29	1,78	OR 19.2-3 N90	19,20	25,20	3,00
OR 8.9-1.9 N90	8,90	12,70	1,90	OR 19.3-2.4 N90	19,30	24,10	2,40
OR 8.9-2.7 N90	8,90	14,30	2,70	OR 19.5-2.5 N90	19,50	24,50	2,50
OR 9-2 N90	9,00	13,00	2,00	OR 19.8-3.6 N90	19,80	27,00	3,60
OR 9-2.5 N90	9,00	14,00	2,50	OR 20-3 N90	20,00	26,00	3,00
OR 9.19-2.62 N90	9,19	14,43	2,62	OR 20-3.5 N90	20,00	27,00	3,50
OR 9.25-1.78 N90	9,25	12,81	1,78	OR 20-4 N90	20,00	28,00	4,00
OR 9.3-2.4 N90	9,30	14,10	2,40	OR 20.22-3.53 N90	20,22	27,28	3,53
OR 9.52-1.78 N90	9,52	13,08	1,78	OR 20.3-2.4 N90	20,30	25,10	2,40
OR 9.9-2.62 N90	9,90	15,14	2,62	OR 20.3-2.62 N90	20,30	25,54	2,62
OR 10-2.5 N90	10,00	15,00	2,50	OR 20.35-1.78 N90	20,35	23,91	1,78
OR 10-3 N90	10,00	16,00	3,00	OR 20.5-2.4 N90	20,50	25,30	2,40
OR 10.3-2.4 N90	10,30	15,10	2,40	OR 21-2 N90	21,00	25,00	2,00
OR 10.5-1 N90	10,50	12,50	1,00	OR 21-2.5 N90	21,00	26,00	2,50
OR 10.5-1.5 N90	10,50	13,50	1,50	OR 21-3 N90	21,00	27,00	3,00
OR 10.5-2 N90	10,50	14,50	2,00	OR 21-4 N90	21,00	29,00	4,00
OR 10.5-2.7 N90	10,50	15,90	2,70	OR 21.3-2.4 N90	21,30	26,10	2,40
OR 10.77-2.62 N90	10,77	16,01	2,62	OR 21.3-3.6 N90	21,30	28,50	3,60
OR 10.82-1.78 N90	10,82	14,38	1,78	OR 21.82-3.53 N90	21,82	28,88	3,53
OR 11-1.5 N90	11,00	14,00	1,50	OR 21.89-2.62 N90	21,89	27,13	2,62
OR 11-2 N90	11,00	15,00	2,00	OR 21.95-1.78 N90	21,95	25,51	1,78
OR 11-2.5 N90	11,00	16,00	2,50	OR 22-2 N90	22,00	26,00	2,00
OR 11.11-1.78 N90	11,11	14,67	1,78	OR 22-3 N90	22,00	28,00	3,00
OR 11.3-2.4 N90	11,30	16,10	2,40	OR 22-4 N90	22,00	30,00	4,00
OR 11.5-2 N90	11,50	15,50	2,00	OR 22.23-2.62 N90	22,23	27,47	2,62
OR 11.91-2.62 N90	11,91	17,15	2,62	OR 22.3-2.4 N90	22,30	27,10	2,40
OR 12-2.5 N90	12,00	17,00	2,50	OR 23-2 N90	23,00	27,00	2,00
OR 12-3 N90	12,00	18,00	3,00	OR 23-2.5 N90	23,00	28,00	2,50
OR 12.1-2.7 N90	12,10	17,50	2,70	OR 23-3 N90	23,00	29,00	3,00
OR 12.3-2.4 N90	12,30	17,10	2,40	OR 23-3.6 N90	23,00	30,20	3,60
OR 12.37-2.62 N90	12,37	17,61	2,62	OR 23.3-2.4 N90	23,30	28,10	2,40
OR 12.42-1.78 N90	12,42	15,98	1,78	OR 23.39-3.53 N90	23,39	30,45	3,53
OR 13-1 N90	13,00	15,00	1,00	OR 23.47-2.62 N90	23,47	28,71	2,62
OR 13-2.5 N90	13,00	18,00	2,50	OR 23.5-3 N90	23,50	29,50	3,00
OR 13-3 N90	13,00	19,00	3,00	OR 23.52-1.78 N90	23,52	27,08	1,78
OR 13.3-2.4 N90	13,30	18,10	2,40	OR 24-2 N90	24,00	28,00	2,00
OR 13.6-2.7 N90	13,60	19,00	2,70	OR 24-2.5 N90	24,00	29,00	2,50
OR 13.94-2.62 N90	13,94	19,18	2,62	OR 24-3 N90	24,00	30,00	3,00
OR 14-1.5 N90	14,00	17,00	1,50	OR 24-4 N90	24,00	32,00	4,00
OR 14-1.78 N90	14,00	17,56	1,78	OR 24.6-3.6 N90	24,60	31,80	3,60
OR 14-2 N90	14,00	18,00	2,00	OR 24.99-3.53 N90	24,99	32,05	3,53
OR 14-2.5 N90	14,00	19,00	2,50	OR 25-2 N90	25,00	29,00	2,00
OR 14-3 N90	14,00	20,00	3,00	OR 25-2.4 N90	25,00	29,80	2,40
OR 14.1-1.6 N90	14,10	17,30	1,60	OR 25-3 N90	25,00	31,00	3,00
OR 14.3-2.4 N90	14,30	19,10	2,40	OR 25-4 N90	25,00	33,00	4,00
OR 15-2.5 N90	15,00	20,00	2,50	OR 25-5 N90	25,00	35,00	5,00
OR 15-3 N90	15,00	21,00	3,00	OR 25.07-2.62 N90	25,07	30,31	2,62
OR 15.08-2.62 N90	15,08	20,32	2,62	OR 25.12-1.78 N90	25,12	28,68	1,78

4



(Continued)

OR 90° Shore NBR

O-ring 90SH NBR

Identification	d1 mm	d2 mm	s mm	Identification	d1 mm	d2 mm	s mm
OR 25.3-2.4 N90	25,30	30,10	2,40	OR 37.82-1.78 N90	37,82	41,38	1,78
OR 25.8-3.53 N90	25,80	32,86	3,53	OR 38-2 N90	38,00	42,00	2,00
OR 26-2.5 N90	26,00	31,00	2,50	OR 38-3 N90	38,00	44,00	3,00
OR 26-3 N90	26,00	32,00	3,00	OR 38-4 N90	38,00	46,00	4,00
OR 26-4 N90	26,00	34,00	4,00	OR 38-5 N90	38,00	48,00	5,00
OR 26-5 N90	26,00	36,00	5,00	OR 39-2.5 N90	39,00	44,00	2,50
OR 26.2-3.6 N90	26,20	33,40	3,60	OR 39-3 N90	39,00	45,00	3,00
OR 26.57-3.53 N90	26,57	33,63	3,53	OR 39-4 N90	39,00	47,00	4,00
OR 26.64-2.62 N90	26,64	31,88	2,62	OR 39.2-5.7 N90	39,20	50,60	5,70
OR 26.7-1.78 N90	26,70	30,26	1,78	OR 39.34-2.62 N90	39,34	44,58	2,62
OR 27-2 N90	27,00	31,00	2,00	OR 39.45-1.78 N90	39,45	43,01	1,78
OR 27-3 N90	27,00	33,00	3,00	OR 39.7-3.53 N90	39,70	46,76	3,53
OR 27.3-2.4 N90	27,30	32,10	2,40	OR 40-2 N90	40,00	44,00	2,00
OR 27.8-3.6 N90	27,80	35,00	3,60	OR 40-2.5 N90	40,00	45,00	2,50
OR 28-2 N90	28,00	32,00	2,00	OR 40-3 N90	40,00	46,00	3,00
OR 28-2.5 N90	28,00	33,00	2,50	OR 40-4 N90	40,00	48,00	4,00
OR 28-3 N90	28,00	34,00	3,00	OR 40-5 N90	40,00	50,00	5,00
OR 28-4 N90	28,00	36,00	4,00	OR 40.64-5.34 N90	40,64	51,32	5,34
OR 28-5 N90	28,00	38,00	5,00	OR 40.87-3.53 N90	40,87	47,93	3,53
OR 28.17-3.53 N90	28,17	35,23	3,53	OR 40.94-2.62 N90	40,94	46,18	2,62
OR 28.24-2.62 N90	28,24	33,48	2,62	OR 41-1.78 N90	41,00	44,56	1,78
OR 28.3-1.78 N90	28,30	31,86	1,78	OR 41-2.5 N90	41,00	46,00	2,50
OR 29-2 N90	29,00	33,00	2,00	OR 41-3 N90	41,00	47,00	3,00
OR 29-2.5 N90	29,00	34,00	2,50	OR 41-3.5 N90	41,00	48,00	3,50
OR 29-3 N90	29,00	35,00	3,00	OR 41-4 N90	41,00	49,00	4,00
OR 29.3-3.6 N90	29,30	36,50	3,60	OR 41.28-3.53 N90	41,28	48,34	3,53
OR 29.6-2.4 N90	29,60	34,40	2,40	OR 42-2 N90	42,00	46,00	2,00
OR 29.74-3.53 N90	29,74	36,80	3,53	OR 42-2.5 N90	42,00	47,00	2,50
OR 29.82-2.62 N90	29,82	35,06	2,62	OR 42-3 N90	42,00	48,00	3,00
OR 29.87-1.78 N90	29,87	33,43	1,78	OR 42-3.5 N90	42,00	49,00	3,50
OR 30-2 N90	30,00	34,00	2,00	OR 42-4 N90	42,00	50,00	4,00
OR 30-2.5 N90	30,00	35,00	2,50	OR 42-5 N90	42,00	52,00	5,00
OR 30-3 N90	30,00	36,00	3,00	OR 42.52-2.62 N90	42,52	47,76	2,62
OR 30-4 N90	30,00	38,00	4,00	OR 42.86-3.53 N90	42,86	49,92	3,53
OR 30-5 N90	30,00	40,00	5,00	OR 43-2 N90	43,00	47,00	2,00
OR 30.3-2.4 N90	30,30	35,10	2,40	OR 43-3 N90	43,00	49,00	3,00
OR 30.8-3.6 N90	30,80	38,00	3,60	OR 43-3.5 N90	43,00	50,00	3,50
OR 31-2 N90	31,00	35,00	2,00	OR 43-4 N90	43,00	51,00	4,00
OR 31-2.5 N90	31,00	36,00	2,50	OR 43.82-5.34 N90	43,82	54,50	5,34
OR 31-3 N90	31,00	37,00	3,00	OR 44-2 N90	44,00	48,00	2,00
OR 31-4 N90	31,00	39,00	4,00	OR 44-2.5 N90	44,00	49,00	2,50
OR 31.12-5.34 N90	31,12	41,80	5,34	OR 44-3 N90	44,00	50,00	3,00
OR 31.34-3.53 N90	31,34	38,40	3,53	OR 44-3.5 N90	44,00	51,00	3,50
OR 31.42-2.62 N90	31,42	36,66	2,62	OR 44-4 N90	44,00	52,00	4,00
OR 31.47-1.78 N90	31,47	35,03	1,78	OR 44-6 N90	44,00	56,00	6,00
OR 32-2 N90	32,00	36,00	2,00	OR 44.04-3.53 N90	44,04	51,10	3,53
OR 32-3 N90	32,00	38,00	3,00	OR 44.12-2.62 N90	44,12	49,36	2,62
OR 32-3.5 N90	32,00	39,00	3,50	OR 44.17-1.78 N90	44,17	47,73	1,78
OR 32-4 N90	32,00	40,00	4,00	OR 44.45-3.53 N90	44,45	51,51	3,53
OR 32-5 N90	32,00	42,00	5,00	OR 45-2 N90	45,00	49,00	2,00
OR 32.5-3.6 N90	32,50	39,70	3,60	OR 45-2.5 N90	45,00	50,00	2,50
OR 32.69-5.34 N90	32,69	43,37	5,34	OR 45-3 N90	45,00	51,00	3,00
OR 32.92-3.53 N90	32,92	39,98	3,53	OR 45-4 N90	45,00	53,00	4,00
OR 32.99-2.62 N90	32,99	38,23	2,62	OR 45-5 N90	45,00	55,00	5,00
OR 33-2 N90	33,00	37,00	2,00	OR 45.69-2.62 N90	45,69	50,93	2,62
OR 33-3 N90	33,00	39,00	3,00	OR 46-2 N90	46,00	50,00	2,00
OR 33.05-1.78 N90	33,05	36,61	1,78	OR 46-2.5 N90	46,00	51,00	2,50
OR 33.3-2.4 N90	33,30	38,10	2,40	OR 46-3 N90	46,00	52,00	3,00
OR 34-2 N90	34,00	38,00	2,00	OR 46-4 N90	46,00	54,00	4,00
OR 34-2.5 N90	34,00	39,00	2,50	OR 46-5 N90	46,00	56,00	5,00
OR 34-3 N90	34,00	40,00	3,00	OR 46.04-3.53 N90	46,04	53,10	3,53
OR 34-4 N90	34,00	42,00	4,00	OR 46.99-5.34 N90	46,99	57,67	5,34
OR 34.1-3.6 N90	34,10	41,30	3,60	OR 47-2 N90	47,00	51,00	2,00
OR 34.29-5.34 N90	34,29	44,97	5,34	OR 47-2.5 N90	47,00	52,00	2,50
OR 34.52-3.53 N90	34,52	41,58	3,53	OR 47-3 N90	47,00	53,00	3,00
OR 34.59-2.62 N90	34,59	39,83	2,62	OR 47-4 N90	47,00	55,00	4,00
OR 34.65-1.78 N90	34,65	38,21	1,78	OR 47.22-3.53 N90	47,22	54,28	3,53
OR 35-2 N90	35,00	39,00	2,00	OR 47.29-2.62 N90	47,29	52,53	2,62
OR 35-2.5 N90	35,00	40,00	2,50	OR 47.35-1.78 N90	47,35	50,91	1,78
OR 35-3 N90	35,00	41,00	3,00	OR 47.62-3.53 N90	47,62	54,68	3,53
OR 35-4 N90	35,00	43,00	4,00	OR 48-2 N90	48,00	52,00	2,00
OR 35-5 N90	35,00	45,00	5,00	OR 48-2.5 N90	48,00	53,00	2,50
OR 35.6-3.6 N90	35,60	42,80	3,60	OR 48-3 N90	48,00	54,00	3,00
OR 36-2 N90	36,00	40,00	2,00	OR 48-4 N90	48,00	56,00	4,00
OR 36-2.5 N90	36,00	41,00	2,50	OR 48-5 N90	48,00	58,00	5,00
OR 36-3 N90	36,00	42,00	3,00	OR 48.9-2.62 N90	48,90	54,14	2,62
OR 36-4 N90	36,00	44,00	4,00	OR 49-2.5 N90	49,00	54,00	2,50
OR 36-5 N90	36,00	46,00	5,00	OR 49-3 N90	49,00	55,00	3,00
OR 36.09-3.53 N90	36,09	43,15	3,53	OR 49-4 N90	49,00	57,00	4,00
OR 36.17-2.62 N90	36,17	41,41	2,62	OR 49.2-3.53 N90	49,20	56,26	3,53
OR 36.27-1.78 N90	36,27	39,83	1,78	OR 49.2-5.7 N90	49,20	60,60	5,70
OR 37-2 N90	37,00	41,00	2,00	OR 50-2 N90	50,00	54,00	2,00
OR 37-2.5 N90	37,00	42,00	2,50	OR 50-2.5 N90	50,00	55,00	2,50
OR 37-3 N90	37,00	43,00	3,00	OR 50-3 N90	50,00	56,00	3,00
OR 37-4 N90	37,00	45,00	4,00	OR 50-5 N90	50,00	60,00	5,00
OR 37.3-3.6 N90	37,30	44,50	3,60	OR 50.17-5.34 N90	50,17	60,85	5,34
OR 37.47-5.34 N90	37,47	48,15	5,34	OR 50.39-3.53 N90	50,39	57,45	3,53
OR 37.69-3.53 N90	37,69	44,75	3,53	OR 50.47-2.62 N90	50,47	55,71	2,62
OR 37.77-2.62 N90	37,77	43,01	2,62	OR 50.52-1.78 N90	50,52	54,08	1,78

Web: <http://cat.hansa-flex.com/en/OR90SHORENBR>

**OR 90° Shore NBR**

(Continued)

**O-ring 90SH NBR**

Identification	d1 mm	d2 mm	s mm
OR 52-3 N90	52,00	58,00	3,00
OR 52-4 N90	52,00	60,00	4,00
OR 52-5 N90	52,00	62,00	5,00
OR 52.07-2.62 N90	52,07	57,31	2,62
OR 52.3-5.7 N90	52,30	63,70	5,70
OR 52.4-3.53 N90	52,40	59,46	3,53
OR 53-2 N90	53,00	57,00	2,00
OR 53-2.5 N90	53,00	58,00	2,50
OR 53-3 N90	53,00	59,00	3,00
OR 53-5 N90	53,00	63,00	5,00
OR 53.34-5.34 N90	53,34	64,02	5,34
OR 53.57-3.53 N90	53,57	60,63	3,53
OR 53.64-2.62 N90	53,64	58,88	2,62
OR 53.7-1.78 N90	53,70	57,26	1,78
OR 54-2 N90	54,00	58,00	2,00
OR 54-2.5 N90	54,00	59,00	2,50
OR 54-3 N90	54,00	60,00	3,00
OR 54-4 N90	54,00	62,00	4,00
OR 54.2-5.7 N90	54,20	65,60	5,70
OR 55-2 N90	55,00	59,00	2,00
OR 55-2.5 N90	55,00	60,00	2,50
OR 55-3 N90	55,00	61,00	3,00
OR 55-3.5 N90	55,00	62,00	3,50
OR 55-4 N90	55,00	63,00	4,00
OR 55-5 N90	55,00	65,00	5,00
OR 55.25-2.62 N90	55,25	60,49	2,62
OR 55.56-3.53 N90	55,56	62,62	3,53
OR 56-2.5 N90	56,00	61,00	2,50
OR 56-3 N90	56,00	62,00	3,00
OR 56-4 N90	56,00	64,00	4,00
OR 56.52-5.34 N90	56,52	67,20	5,34
OR 56.74-3.53 N90	56,74	63,80	3,53
OR 56.82-2.62 N90	56,82	62,06	2,62
OR 56.87-1.78 N90	56,87	60,43	1,78
OR 57-2.5 N90	57,00	62,00	2,50
OR 57-3 N90	57,00	63,00	3,00
OR 57.15-3.53 N90	57,15	64,21	3,53
OR 58-2 N90	58,00	62,00	2,00
OR 58-3 N90	58,00	64,00	3,00
OR 58-4 N90	58,00	66,00	4,00
OR 58.42-2.62 N90	58,42	63,66	2,62
OR 58.74-3.53 N90	58,74	65,80	3,53
OR 59-2.5 N90	59,00	64,00	2,50
OR 59-3 N90	59,00	65,00	3,00
OR 59.2-5.7 N90	59,20	70,60	5,70
OR 59.5-3 N90	59,50	65,50	3,00
OR 59.69-5.34 N90	59,69	70,37	5,34
OR 59.92-3.53 N90	59,92	66,98	3,53
OR 59.99-2.62 N90	59,99	65,23	2,62
OR 60-2 N90	60,00	64,00	2,00
OR 60-2.5 N90	60,00	65,00	2,50
OR 60-3 N90	60,00	66,00	3,00
OR 60-4 N90	60,00	68,00	4,00
OR 60-5 N90	60,00	70,00	5,00
OR 60.05-1.78 N90	60,05	63,61	1,78
OR 60.32-3.53 N90	60,32	67,38	3,53
OR 61.2-5.7 N90	61,20	72,60	5,70
OR 61.9-3.53 N90	61,90	68,96	3,53
OR 62-2 N90	62,00	66,00	2,00
OR 62-2.5 N90	62,00	67,00	2,50
OR 62-3 N90	62,00	68,00	3,00
OR 62-3.5 N90	62,00	69,00	3,50
OR 62-4 N90	62,00	70,00	4,00
OR 62-5 N90	62,00	72,00	5,00
OR 62.3-5.7 N90	62,30	73,70	5,70
OR 62.6-2.62 N90	62,60	67,84	2,62
OR 62.87-5.34 N90	62,87	73,55	5,34
OR 63-2 N90	63,00	67,00	2,00
OR 63-2.5 N90	63,00	68,00	2,50
OR 63-3 N90	63,00	69,00	3,00
OR 63-4 N90	63,00	71,00	4,00
OR 63.09-3.53 N90	63,09	70,15	3,53
OR 63.17-2.62 N90	63,17	68,41	2,62
OR 63.22-1.78 N90	63,22	66,78	1,78
OR 64-3 N90	64,00	70,00	3,00
OR 64-4 N90	64,00	72,00	4,00
OR 64-5 N90	64,00	74,00	5,00
OR 64.3-5.7 N90	64,30	75,70	5,70
OR 64.77-2.62 N90	64,77	70,01	2,62
OR 65-2 N90	65,00	69,00	2,00
OR 65-3 N90	65,00	71,00	3,00
OR 65-3.5 N90	65,00	72,00	3,50
OR 65-4 N90	65,00	73,00	4,00
OR 65-5 N90	65,00	75,00	5,00
OR 65.1-3.53 N90	65,10	72,16	3,53
OR 66-2 N90	66,00	70,00	2,00
OR 66-3 N90	66,00	72,00	3,00
OR 66.04-5.34 N90	66,04	76,72	5,34
OR 66.27-3.53 N90	66,27	73,33	3,53

Identification	d1 mm	d2 mm	s mm
OR 66.34-2.62 N90	66,34	71,58	2,62
OR 67-2.5 N90	67,00	72,00	2,50
OR 67-3 N90	67,00	73,00	3,00
OR 67-4 N90	67,00	75,00	4,00
OR 67-5 N90	67,00	77,00	5,00
OR 67.95-2.62 N90	67,95	73,19	2,62
OR 68-2.5 N90	68,00	73,00	2,50
OR 68-3 N90	68,00	74,00	3,00
OR 68.26-3.53 N90	68,26	75,32	3,53
OR 69.2-5.7 N90	69,20	80,60	5,70
OR 69.22-5.34 N90	69,22	79,90	5,34
OR 69.3-5.7 N90	69,30	80,70	5,70
OR 69.44-3.53 N90	69,44	76,50	3,53
OR 69.52-2.62 N90	69,52	74,76	2,62
OR 69.85-3.53 N90	69,85	76,91	3,53
OR 70-2 N90	70,00	74,00	2,00
OR 70-2.5 N90	70,00	75,00	2,50
OR 70-3 N90	70,00	76,00	3,00
OR 70-3.5 N90	70,00	77,00	3,50
OR 70-4 N90	70,00	78,00	4,00
OR 70-5 N90	70,00	80,00	5,00
OR 71-3 N90	71,00	77,00	3,00
OR 71.12-2.62 N90	71,12	76,36	2,62
OR 72-2 N90	72,00	76,00	2,00
OR 72-3 N90	72,00	78,00	3,00
OR 72-4 N90	72,00	80,00	4,00
OR 72-5 N90	72,00	82,00	5,00
OR 72.2-5.7 N90	72,20	83,60	5,70
OR 72.39-5.34 N90	72,39	83,07	5,34
OR 72.62-3.53 N90	72,62	79,68	3,53
OR 73-3 N90	73,00	79,00	3,00
OR 73-4 N90	73,00	81,00	4,00
OR 73-5 N90	73,00	83,00	5,00
OR 73.02-3.53 N90	73,02	80,08	3,53
OR 74-3 N90	74,00	80,00	3,00
OR 74-4 N90	74,00	82,00	4,00
OR 74.2-5.7 N90	74,20	85,60	5,70
OR 74.6-3.53 N90	74,60	81,66	3,53
OR 75-2 N90	75,00	79,00	2,00
OR 75-2.5 N90	75,00	80,00	2,50
OR 75-3 N90	75,00	81,00	3,00
OR 75-3.5 N90	75,00	82,00	3,50
OR 75-4 N90	75,00	83,00	4,00
OR 75-5 N90	75,00	85,00	5,00
OR 75.57-5.34 N90	75,57	86,25	5,34
OR 75.79-3.53 N90	75,79	82,85	3,53
OR 75.87-2.62 N90	75,87	81,11	2,62
OR 76-2.5 N90	76,00	81,00	2,50
OR 76-3 N90	76,00	82,00	3,00
OR 76-4 N90	76,00	84,00	4,00
OR 77-3 N90	77,00	83,00	3,00
OR 77-5 N90	77,00	87,00	5,00
OR 78-2 N90	78,00	82,00	2,00
OR 78-4 N90	78,00	86,00	4,00
OR 78.74-5.34 N90	78,74	89,42	5,34
OR 78.97-3.53 N90	78,97	86,03	3,53
OR 79-1.78 N90	79,00	82,56	1,78
OR 79-3 N90	79,00	85,00	3,00
OR 79.3-5.7 N90	79,30	90,70	5,70
OR 79.73-5.34 N90	79,73	90,41	5,34
OR 80-2 N90	80,00	84,00	2,00
OR 80-2.5 N90	80,00	85,00	2,50
OR 80-3 N90	80,00	86,00	3,00
OR 80-4 N90	80,00	88,00	4,00
OR 80-5 N90	80,00	90,00	5,00
OR 81.92-5.34 N90	81,92	92,60	5,34
OR 82-2 N90	82,00	86,00	2,00
OR 82-3 N90	82,00	88,00	3,00
OR 82-3.5 N90	82,00	89,00	3,50
OR 82-4 N90	82,00	90,00	4,00
OR 82-5 N90	82,00	92,00	5,00
OR 82.14-3.53 N90	82,14	89,20	3,53
OR 82.2-5.7 N90	82,20	93,60	5,70
OR 82.22-2.62 N90	82,22	87,46	2,62
OR 82.27-1.78 N90	82,27	85,83	1,78
OR 83-3 N90	83,00	89,00	3,00
OR 84-3 N90	84,00	90,00	3,00
OR 84.3-5.7 N90	84,30	95,70	5,70
OR 85-2 N90	85,00	89,00	2,00
OR 85-2.5 N90	85,00	90,00	2,50
OR 85-3 N90	85,00	91,00	3,00
OR 85-3.5 N90	85,00	92,00	3,50
OR 85-4 N90	85,00	93,00	4,00
OR 85-5 N90	85,00	95,00	5,00
OR 85.09-5.34 N90	85,09	95,77	5,34
OR 85.32-3.53 N90	85,32	92,38	3,53
OR 86-2 N90	86,00	90,00	2,00
OR 86-2.5 N90	86,00	91,00	2,50
OR 86-3 N90	86,00	92,00	3,00

Web: <http://cat.hansa-flex.com/en/OR90SHORENBR>

(Continued)

OR 90° Shore NBR

O-ring 90SH NBR

Identification	d1	d2	s	Identification	d1	d2	s
	mm	mm	mm		mm	mm	mm
OR 86-4 N90	86,00	94,00	4,00	OR 120.02-7 N90	120,02	134,02	7,00
OR 88-3 N90	88,00	94,00	3,00	OR 120.24-3.53 N90	120,24	127,30	3,53
OR 88-6 N90	88,00	100,00	6,00	OR 122-5 N90	122,00	132,00	5,00
OR 88.27-2.62 N90	88,27	93,51	2,62	OR 123.19-5.34 N90	123,19	133,87	5,34
OR 88.27-5.34 N90	88,27	98,95	5,34	OR 123.19-7 N90	123,19	137,19	7,00
OR 88.49-3.53 N90	88,49	95,55	3,53	OR 123.42-3.53 N90	123,42	130,48	3,53
OR 89.2-5.7 N90	89,20	100,60	5,70	OR 123.83-5.34 N90	123,83	134,51	5,34
OR 89.5-3 N90	89,50	95,50	3,00	OR 124-3 N90	124,00	130,00	3,00
OR 89.69-5.34 N90	89,69	100,37	5,34	OR 124.3-5.7 N90	124,30	135,70	5,70
OR 90-2 N90	90,00	94,00	2,00	OR 125-3 N90	125,00	131,00	3,00
OR 90-2.5 N90	90,00	95,00	2,50	OR 125-4 N90	125,00	133,00	4,00
OR 90-3 N90	90,00	96,00	3,00	OR 125-5 N90	125,00	135,00	5,00
OR 90-4 N90	90,00	98,00	4,00	OR 126-3.5 N90	126,00	133,00	3,50
OR 90-5 N90	90,00	100,00	5,00	OR 126.37-7 N90	126,37	140,37	7,00
OR 91.44-5.34 N90	91,44	102,12	5,34	OR 126.59-3.53 N90	126,59	133,65	3,53
OR 91.67-3.53 N90	91,67	98,73	3,53	OR 127-5.34 N90	127,00	137,68	5,34
OR 92-2 N90	92,00	96,00	2,00	OR 128-3 N90	128,00	134,00	3,00
OR 92-3 N90	92,00	98,00	3,00	OR 129.3-5.7 N90	129,30	140,70	5,70
OR 92-4 N90	92,00	100,00	4,00	OR 129.54-5.34 N90	129,54	140,22	5,34
OR 92-5 N90	92,00	102,00	5,00	OR 129.54-7 N90	129,54	143,54	7,00
OR 93-3 N90	93,00	99,00	3,00	OR 129.77-3.53 N90	129,77	136,83	3,53
OR 94-2 N90	94,00	98,00	2,00	OR 130-3 N90	130,00	136,00	3,00
OR 94-2.5 N90	94,00	99,00	2,50	OR 130-4 N90	130,00	138,00	4,00
OR 94-3 N90	94,00	100,00	3,00	OR 130-5 N90	130,00	140,00	5,00
OR 94.3-5.7 N90	94,30	105,70	5,70	OR 132-3 N90	132,00	138,00	3,00
OR 94.62-5.34 N90	94,62	105,30	5,34	OR 132.72-5.34 N90	132,72	143,40	5,34
OR 94.84-3.53 N90	94,84	101,90	3,53	OR 132.72-7 N90	132,72	146,72	7,00
OR 94.92-2.62 N90	94,92	100,16	2,62	OR 132.94-3.53 N90	132,94	140,00	3,53
OR 95-3 N90	95,00	101,00	3,00	OR 133.35-5.34 N90	133,35	144,03	5,34
OR 95-4 N90	95,00	103,00	4,00	OR 134-3 N90	134,00	140,00	3,00
OR 95-5 N90	95,00	105,00	5,00	OR 134-4 N90	134,00	142,00	4,00
OR 96-2 N90	96,00	100,00	2,00	OR 134.3-5.7 N90	134,30	145,70	5,70
OR 96-3 N90	96,00	102,00	3,00	OR 135-5 N90	135,00	145,00	5,00
OR 96-4 N90	96,00	104,00	4,00	OR 135.89-5.34 N90	135,89	146,57	5,34
OR 97.79-5.34 N90	97,79	108,47	5,34	OR 135.89-7 N90	135,89	149,89	7,00
OR 98-3 N90	98,00	104,00	3,00	OR 136-3 N90	136,00	142,00	3,00
OR 98.02-3.53 N90	98,02	105,08	3,53	OR 136-4 N90	136,00	144,00	4,00
OR 99-5.7 N90	99,00	110,40	5,70	OR 136.12-3.53 N90	136,12	143,18	3,53
OR 99.2-5.7 N90	99,20	110,60	5,70	OR 139.07-5.34 N90	139,07	149,75	5,34
OR 100-2 N90	100,00	104,00	2,00	OR 139.07-7 N90	139,07	153,07	7,00
OR 100-3 N90	100,00	106,00	3,00	OR 139.29-3.53 N90	139,29	146,35	3,53
OR 100-4 N90	100,00	108,00	4,00	OR 139.3-5.7 N90	139,30	150,70	5,70
OR 100-5 N90	100,00	110,00	5,00	OR 140-3 N90	140,00	146,00	3,00
OR 100.97-5.34 N90	100,97	111,65	5,34	OR 140-4 N90	140,00	148,00	4,00
OR 101.19-3.53 N90	101,19	108,25	3,53	OR 140-5 N90	140,00	150,00	5,00
OR 101.27-2.62 N90	101,27	106,51	2,62	OR 142-6 N90	142,00	154,00	6,00
OR 102-3 N90	102,00	108,00	3,00	OR 142.24-7 N90	142,24	156,24	7,00
OR 102-4 N90	102,00	110,00	4,00	OR 143-3 N90	143,00	149,00	3,00
OR 104-4 N90	104,00	112,00	4,00	OR 144.3-5.7 N90	144,30	155,70	5,70
OR 104.14-5.34 N90	104,14	114,82	5,34	OR 144.5-3 N90	144,50	150,50	3,00
OR 104.3-5.7 N90	104,30	115,70	5,70	OR 145-3 N90	145,00	151,00	3,00
OR 104.37-3.53 N90	104,37	111,43	3,53	OR 145-4 N90	145,00	153,00	4,00
OR 105-3 N90	105,00	111,00	3,00	OR 145-5 N90	145,00	155,00	5,00
OR 105-4 N90	105,00	113,00	4,00	OR 145.42-5.34 N90	145,42	156,10	5,34
OR 105-5 N90	105,00	115,00	5,00	OR 145.42-7 N90	145,42	159,42	7,00
OR 107-5 N90	107,00	117,00	5,00	OR 145.64-3.53 N90	145,64	152,70	3,53
OR 107.32-5.34 N90	107,32	118,00	5,34	OR 145.72-2.62 N90	145,72	150,96	2,62
OR 107.54-3.53 N90	107,54	114,60	3,53	OR 146-6 N90	146,00	158,00	6,00
OR 107.62-2.62 N90	107,62	112,86	2,62	OR 146.05-5.34 N90	146,05	156,73	5,34
OR 108-3 N90	108,00	114,00	3,00	OR 148-3 N90	148,00	154,00	3,00
OR 109-5.7 N90	109,00	120,40	5,70	OR 148-6 N90	148,00	160,00	6,00
OR 109.2-5.7 N90	109,20	120,60	5,70	OR 148.59-5.34 N90	148,59	159,27	5,34
OR 109.54-5.34 N90	109,54	120,22	5,34	OR 148.59-7 N90	148,59	162,59	7,00
OR 110-4 N90	110,00	118,00	4,00	OR 148.82-3.53 N90	148,82	155,88	3,53
OR 110-5 N90	110,00	120,00	5,00	OR 149.2-5.7 N90	149,20	160,60	5,70
OR 110.49-5.34 N90	110,49	121,17	5,34	OR 149.23-5.34 N90	149,23	159,91	5,34
OR 110.72-3.53 N90	110,72	117,78	3,53	OR 150-4 N90	150,00	158,00	4,00
OR 112-3 N90	112,00	118,00	3,00	OR 150-5 N90	150,00	160,00	5,00
OR 113.67-5.34 N90	113,67	124,35	5,34	OR 150-6 N90	150,00	162,00	6,00
OR 113.67-7 N90	113,67	127,67	7,00	OR 151.77-5.34 N90	151,77	162,45	5,34
OR 113.89-3.53 N90	113,89	120,95	3,53	OR 151.77-7 N90	151,77	165,77	7,00
OR 114-3 N90	114,00	120,00	3,00	OR 151.99-3.53 N90	151,99	159,05	3,53
OR 114.3-5.7 N90	114,30	125,70	5,70	OR 154-3 N90	154,00	160,00	3,00
OR 115-3 N90	115,00	121,00	3,00	OR 154.3-5.7 N90	154,30	165,70	5,70
OR 115-4 N90	115,00	123,00	4,00	OR 155-4 N90	155,00	163,00	4,00
OR 115-5 N90	115,00	125,00	5,00	OR 155-5 N90	155,00	165,00	5,00
OR 116-3 N90	116,00	122,00	3,00	OR 158.12-5.34 N90	158,12	168,80	5,34
OR 116.84-5.34 N90	116,84	127,52	5,34	OR 158.12-7 N90	158,12	172,12	7,00
OR 116.84-7 N90	116,84	130,84	7,00	OR 158.34-3.53 N90	158,34	165,40	3,53
OR 117-4 N90	117,00	125,00	4,00	OR 159.3-5.7 N90	159,30	170,70	5,70
OR 117.07-3.53 N90	117,07	124,13	3,53	OR 160-3 N90	160,00	166,00	3,00
OR 117.48-5.34 N90	117,48	128,16	5,34	OR 160-4 N90	160,00	168,00	4,00
OR 118-4 N90	118,00	126,00	4,00	OR 160-5 N90	160,00	170,00	5,00
OR 119-3 N90	119,00	125,00	3,00	OR 162-3 N90	162,00	168,00	3,00
OR 119.3-5.7 N90	119,30	130,70	5,70	OR 164.3-5.7 N90	164,30	175,70	5,70
OR 120-3 N90	120,00	126,00	3,00	OR 164.47-5.34 N90	164,47	175,15	5,34
OR 120-4 N90	120,00	128,00	4,00	OR 164.47-7 N90	164,47	178,47	7,00
OR 120-5 N90	120,00	130,00	5,00	OR 164.69-3.53 N90	164,69	171,75	3,53
OR 120.02-5.34 N90	120,02	130,70	5,34	OR 165-3 N90	165,00	171,00	3,00

Web: <http://cat.hansa-flex.com/en/OR90SHORENBR>

**OR 90° Shore NBR**

(Continued)

**O-ring 90SH NBR**

Identification	d1 mm	d2 mm	s mm
OR 165-4 N90	165,00	173,00	4,00
OR 165-5 N90	165,00	175,00	5,00
OR 166.7-7 N90	166,70	180,70	7,00
OR 168-3 N90	168,00	174,00	3,00
OR 169.3-5.7 N90	169,30	180,70	5,70
OR 170-3 N90	170,00	176,00	3,00
OR 170-5 N90	170,00	180,00	5,00
OR 170.82-5.34 N90	170,82	181,50	5,34
OR 170.82-7 N90	170,82	184,82	7,00
OR 171.04-3.53 N90	171,04	178,10	3,53
OR 173-5 N90	173,00	183,00	5,00
OR 175-5 N90	175,00	185,00	5,00
OR 175-6 N90	175,00	187,00	6,00
OR 177.17-7 N90	177,17	191,17	7,00
OR 177.39-3.53 N90	177,39	184,45	3,53
OR 180-3 N90	180,00	186,00	3,00
OR 180-4 N90	180,00	188,00	4,00
OR 180-5 N90	180,00	190,00	5,00
OR 183.52-5.34 N90	183,52	194,20	5,34
OR 183.52-7 N90	183,52	197,52	7,00
OR 183.74-3.53 N90	183,74	190,80	3,53
OR 184.3-5.7 N90	184,30	195,70	5,70
OR 184.5-3 N90	184,50	190,50	3,00
OR 185-5 N90	185,00	195,00	5,00
OR 189.3-5.7 N90	189,30	200,70	5,70
OR 189.87-5.34 N90	189,87	200,55	5,34
OR 189.87-7 N90	189,87	203,87	7,00
OR 190-3 N90	190,00	196,00	3,00
OR 190-4 N90	190,00	198,00	4,00
OR 190-5 N90	190,00	200,00	5,00
OR 190.09-3.53 N90	190,09	197,15	3,53
OR 194.3-5.7 N90	194,30	205,70	5,70
OR 195-4 N90	195,00	203,00	4,00
OR 195-5 N90	195,00	205,00	5,00
OR 196.22-5.34 N90	196,22	206,90	5,34
OR 196.22-7 N90	196,22	210,22	7,00
OR 199.3-5.7 N90	199,30	210,70	5,70
OR 200-3 N90	200,00	206,00	3,00
OR 200-5 N90	200,00	210,00	5,00
OR 202.57-5.34 N90	202,57	213,25	5,34
OR 202.57-7 N90	202,57	216,57	7,00
OR 202.79-3.53 N90	202,79	209,85	3,53
OR 205-5 N90	205,00	215,00	5,00
OR 208.92-7 N90	208,92	222,92	7,00
OR 209.3-5.7 N90	209,30	220,70	5,70
OR 210-5 N90	210,00	220,00	5,00
OR 215-5 N90	215,00	225,00	5,00
OR 215.27-5.34 N90	215,27	225,95	5,34

Identification	d1 mm	d2 mm	s mm
OR 215.27-7 N90	215,27	229,27	7,00
OR 219.3-5.7 N90	219,30	230,70	5,70
OR 220-5 N90	220,00	230,00	5,00
OR 221.62-5.34 N90	221,62	232,30	5,34
OR 225-3 N90	225,00	231,00	3,00
OR 225-5 N90	225,00	235,00	5,00
OR 227.97-5.34 N90	227,97	238,65	5,34
OR 227.97-7 N90	227,97	241,97	7,00
OR 229.3-5.7 N90	229,30	240,70	5,70
OR 230-5 N90	230,00	240,00	5,00
OR 234.32-5.34 N90	234,32	245,00	5,34
OR 234.32-7 N90	234,32	248,32	7,00
OR 235-5 N90	235,00	245,00	5,00
OR 239.3-5.7 N90	239,30	250,70	5,70
OR 240-5 N90	240,00	250,00	5,00
OR 240.67-5.34 N90	240,67	251,35	5,34
OR 240.67-7 N90	240,67	254,67	7,00
OR 240.89-3.53 N90	240,89	247,95	3,53
OR 247.02-5.34 N90	247,02	257,70	5,34
OR 249.3-5.7 N90	249,30	260,70	5,70
OR 250-5 N90	250,00	260,00	5,00
OR 253.37-7 N90	253,37	267,37	7,00
OR 253.59-3.53 N90	253,59	260,65	3,53
OR 260-5 N90	260,00	270,00	5,00
OR 266.07-5.34 N90	266,07	276,75	5,34
OR 266.07-7 N90	266,07	280,07	7,00
OR 270-5 N90	270,00	280,00	5,00
OR 278.77-5.34 N90	278,77	289,45	5,34
OR 278.77-7 N90	278,77	292,77	7,00
OR 280-5 N90	280,00	290,00	5,00
OR 285.1-7 N90	285,10	299,10	7,00
OR 290-5 N90	290,00	300,00	5,00
OR 291.47-7 N90	291,47	305,47	7,00
OR 304.17-7 N90	304,17	318,17	7,00
OR 304.39-3.53 N90	304,39	311,45	3,53
OR 316.87-7 N90	316,87	330,87	7,00
OR 329.57-7 N90	329,57	343,57	7,00
OR 329.79-3.53 N90	329,79	336,85	3,53
OR 342.27-7 N90	342,27	356,27	7,00
OR 354.97-7 N90	354,97	368,97	7,00
OR 359.3-5.7 N90	359,30	370,70	5,70
OR 367.67-7 N90	367,67	381,67	7,00
OR 380.37-7 N90	380,37	394,37	7,00
OR 393.07-7 N90	393,07	407,07	7,00
OR 405.26-7 N90	405,26	419,26	7,00
OR 417.96-7 N90	417,96	431,96	7,00
OR 439.3-5.7 N90	439,30	450,70	5,70

Web: <http://cat.hansa-flex.com/en/OR90SHORENBR>

4



OR 80° Shore FPM

O-ring 80SH FKM (FPM)

**Design:** O-ring  
**Temp. min.:** -20 °C  
**Temp. max.:** 200 °C  
**Material:** FPM 80 Shore

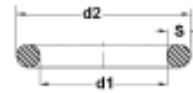

Identification	d1 mm	d2 mm	s mm
OR 2-1.5 V	2,00	5,00	1,50
OR 2.57-1.78 V	2,57	6,13	1,78
OR 2.9-1.78 V	2,90	6,46	1,78
OR 3-1 V	3,00	5,00	1,00
OR 3-1.5 V	3,00	6,00	1,50
OR 3-2 V	3,00	7,00	2,00
OR 3.3-2.4 V	3,30	8,10	2,40
OR 3.5-1.5 V	3,50	6,50	1,50
OR 3.5-2 V	3,50	7,50	2,00
OR 3.68-1.78 V	3,68	7,24	1,78
OR 4-1 V	4,00	6,00	1,00
OR 4-1.5 V	4,00	7,00	1,50
OR 4-2 V	4,00	8,00	2,00
OR 4-2.5 V	4,00	9,00	2,50
OR 4.2-1.9 V	4,20	8,00	1,90
OR 4.3-2.4 V	4,30	9,10	2,40
OR 4.47-1.78 V	4,47	8,03	1,78
OR 4.5-1.5 V	4,50	7,50	1,50
OR 4.76-1.78 V	4,76	8,32	1,78
OR 5-1 V	5,00	7,00	1,00
OR 5-1.5 V	5,00	8,00	1,50
OR 5-1.6 V	5,00	8,20	1,60
OR 5-2 V	5,00	9,00	2,00
OR 5-2.5 V	5,00	10,00	2,50
OR 5-3 V	5,00	11,00	3,00
OR 5.23-2.62 V	5,23	10,47	2,62
OR 5.28-1.78 V	5,28	8,84	1,78
OR 5.3-2.4 V	5,30	10,10	2,40
OR 5.5-1.5 V	5,50	8,50	1,50
OR 6-1 V	6,00	8,00	1,00
OR 6-1.5 V	6,00	9,00	1,50
OR 6-2 V	6,00	10,00	2,00
OR 6-2.5 V	6,00	11,00	2,50
OR 6-3 V	6,00	12,00	3,00
OR 6.02-2.62 V	6,02	11,26	2,62
OR 6.07-1.78 V	6,07	9,63	1,78
OR 6.2-1 V	6,20	8,20	1,00
OR 6.3-2.4 V	6,30	11,10	2,40
OR 6.4-1.9 V	6,40	10,20	1,90
OR 6.5-1.5 V	6,50	9,50	1,50
OR 6.5-2 V	6,50	10,50	2,00
OR 6.75-1.78 V	6,75	10,31	1,78
OR 7-1.5 V	7,00	10,00	1,50
OR 7-2 V	7,00	11,00	2,00
OR 7-2.5 V	7,00	12,00	2,50
OR 7-3 V	7,00	13,00	3,00
OR 7.1-1.6 V	7,10	10,30	1,60
OR 7.2-1.9 V	7,20	11,00	1,90
OR 7.3-2.4 V	7,30	12,10	2,40
OR 7.5-1.5 V	7,50	10,50	1,50
OR 7.5-2 V	7,50	11,50	2,00
OR 7.59-2.62 V	7,59	12,83	2,62
OR 7.65-1.78 V	7,65	11,21	1,78
OR 7.94-1.78 V	7,94	11,50	1,78
OR 8-1 V	8,00	10,00	1,00
OR 8-1.5 V	8,00	11,00	1,50
OR 8-1.8 V	8,00	11,60	1,80
OR 8-1.9 V	8,00	11,80	1,90
OR 8-2 V	8,00	12,00	2,00
OR 8-2.5 V	8,00	13,00	2,50
OR 8-3 V	8,00	14,00	3,00
OR 8-4 V	8,00	16,00	4,00
OR 8.3-2.4 V	8,30	13,10	2,40
OR 8.5-1.5 V	8,50	11,50	1,50
OR 8.73-1.78 V	8,73	12,29	1,78
OR 9-1 V	9,00	11,00	1,00
OR 9-1.5 V	9,00	12,00	1,50
OR 9-1.8 V	9,00	12,60	1,80
OR 9-2 V	9,00	13,00	2,00
OR 9-2.5 V	9,00	14,00	2,50
OR 9-3 V	9,00	15,00	3,00
OR 9-6 V	9,00	21,00	6,00
OR 9.12-3.53 V	9,12	16,18	3,53
OR 9.19-2.62 V	9,19	14,43	2,62
OR 9.25-1.78 V	9,25	12,81	1,78
OR 9.3-2.4 V	9,30	14,10	2,40
OR 9.5-1.5 V	9,50	12,50	1,50

Identification	d1 mm	d2 mm	s mm
OR 9.5-2 V	9,50	13,50	2,00
OR 9.52-1.78 V	9,52	13,08	1,78
OR 10-1 V	10,00	12,00	1,00
OR 10-1.5 V	10,00	13,00	1,50
OR 10-2 V	10,00	14,00	2,00
OR 10-2.5 V	10,00	15,00	2,50
OR 10-3 V	10,00	16,00	3,00
OR 10-4 V	10,00	18,00	4,00
OR 10.3-2.4 V	10,30	15,10	2,40
OR 10.5-1.5 V	10,50	13,50	1,50
OR 10.5-2.7 V	10,50	15,90	2,70
OR 10.69-3.53 V	10,69	17,75	3,53
OR 10.77-2.62 V	10,77	16,01	2,62
OR 10.82-1.78 V	10,82	14,38	1,78
OR 11-1.5 V	11,00	14,00	1,50
OR 11-2 V	11,00	15,00	2,00
OR 11-2.5 V	11,00	16,00	2,50
OR 11-3 V	11,00	17,00	3,00
OR 11.2-1.8 V	11,20	14,80	1,80
OR 11.3-2.4 V	11,30	16,10	2,40
OR 12-1 V	12,00	14,00	1,00
OR 12-1.5 V	12,00	15,00	1,50
OR 12-1.7 V	12,00	15,40	1,70
OR 12-2 V	12,00	16,00	2,00
OR 12-2.5 V	12,00	17,00	2,50
OR 12-3 V	12,00	18,00	3,00
OR 12-4 V	12,00	20,00	4,00
OR 12-5 V	12,00	22,00	5,00
OR 12.1-1.6 V	12,10	15,30	1,60
OR 12.1-2.7 V	12,10	17,50	2,70
OR 12.29-3.53 V	12,29	19,35	3,53
OR 12.3-2.4 V	12,30	17,10	2,40
OR 12.37-2.62 V	12,37	17,61	2,62
OR 12.42-1.78 V	12,42	15,98	1,78
OR 13-1 V	13,00	15,00	1,00
OR 13-1.5 V	13,00	16,00	1,50
OR 13-2 V	13,00	17,00	2,00
OR 13-2.5 V	13,00	18,00	2,50
OR 13-3 V	13,00	19,00	3,00
OR 13.1-1.6 V	13,10	16,30	1,60
OR 13.1-2.62 V	13,10	18,34	2,62
OR 13.3-2.4 V	13,30	18,10	2,40
OR 13.46-2.08 V	13,46	17,62	2,08
OR 13.5-1.5 V	13,50	16,50	1,50
OR 13.5-2.5 V	13,50	18,50	2,50
OR 13.94-2.62 V	13,94	19,18	2,62
OR 14-1 V	14,00	16,00	1,00
OR 14-1.5 V	14,00	17,00	1,50
OR 14-1.78 V	14,00	17,56	1,78
OR 14-2 V	14,00	18,00	2,00
OR 14-2.5 V	14,00	19,00	2,50
OR 14-3 V	14,00	20,00	3,00
OR 14-5 V	14,00	24,00	5,00
OR 14.1-1.6 V	14,10	17,30	1,60
OR 14.3-2.4 V	14,30	19,10	2,40
OR 14.5-3 V	14,50	20,50	3,00
OR 15-1.5 V	15,00	18,00	1,50
OR 15-2 V	15,00	19,00	2,00
OR 15-2.5 V	15,00	20,00	2,50
OR 15-3 V	15,00	21,00	3,00
OR 15-4 V	15,00	23,00	4,00
OR 15-5 V	15,00	25,00	5,00
OR 15-6 V	15,00	27,00	6,00
OR 15.08-2.62 V	15,08	20,32	2,62
OR 15.1-1.6 V	15,10	18,30	1,60
OR 15.1-2.7 V	15,10	20,50	2,70
OR 15.3-2.4 V	15,30	20,10	2,40
OR 15.47-3.53 V	15,47	22,53	3,53
OR 15.54-2.62 V	15,54	20,78	2,62
OR 15.6-1.78 V	15,60	19,16	1,78
OR 15.88-2.62 V	15,88	21,12	2,62
OR 16-1.5 V	16,00	19,00	1,50
OR 16-2 V	16,00	20,00	2,00
OR 16-2.5 V	16,00	21,00	2,50
OR 16-3 V	16,00	22,00	3,00
OR 16-4 V	16,00	24,00	4,00
OR 16.3-2.4 V	16,30	21,10	2,40

## OR 80° Shore FPM

(Continued)

## O-ring 80SH FKM (FPM)

Identification	d1 mm	d2 mm	s mm	Identification	d1 mm	d2 mm	s mm
OR 16.9-2.7 V	16,90	22,30	2,70	OR 25-2.5 V	25,00	30,00	2,50
OR 17-1.5 V	17,00	20,00	1,50	OR 25-3 V	25,00	31,00	3,00
OR 17-2 V	17,00	21,00	2,00	OR 25-3.5 V	25,00	32,00	3,50
OR 17-2.5 V	17,00	22,00	2,50	OR 25-4 V	25,00	33,00	4,00
OR 17-3 V	17,00	23,00	3,00	OR 25-5 V	25,00	35,00	5,00
OR 17.12-2.62 V	17,12	22,36	2,62	OR 25.04-2.95 V	25,04	30,94	2,95
OR 17.13-2.62 V	17,13	22,37	2,62	OR 25.07-2.62 V	25,07	30,31	2,62
OR 17.16-1.78 V	17,16	20,72	1,78	OR 25.12-1.78 V	25,12	28,68	1,78
OR 17.17-1.78 V	17,17	20,73	1,78	OR 25.3-2.4 V	25,30	30,10	2,40
OR 17.3-2.4 V	17,30	22,10	2,40	OR 25.8-3.53 V	25,80	32,86	3,53
OR 18-2 V	18,00	22,00	2,00	OR 26-2 V	26,00	30,00	2,00
OR 18-2.2 V	18,00	22,40	2,20	OR 26-2.5 V	26,00	31,00	2,50
OR 18-2.5 V	18,00	23,00	2,50	OR 26-3 V	26,00	32,00	3,00
OR 18-3 V	18,00	24,00	3,00	OR 26-5 V	26,00	36,00	5,00
OR 18-3.5 V	18,00	25,00	3,50	OR 26.5-3.55 V	26,50	33,60	3,55
OR 18-4 V	18,00	26,00	4,00	OR 26.57-3.53 V	26,57	33,63	3,53
OR 18-5 V	18,00	28,00	5,00	OR 26.59-2.95 V	26,59	32,49	2,95
OR 18.2-3 V	18,20	24,20	3,00	OR 26.64-2.62 V	26,64	31,88	2,62
OR 18.3-3.6 V	18,30	25,50	3,60	OR 26.7-1.78 V	26,70	30,26	1,78
OR 18.4-2.7 V	18,40	23,80	2,70	OR 27-1.5 V	27,00	30,00	1,50
OR 18.64-3.53 V	18,64	25,70	3,53	OR 27-2 V	27,00	31,00	2,00
OR 18.72-2.62 V	18,72	23,96	2,62	OR 27-2.5 V	27,00	32,00	2,50
OR 18.77-1.78 V	18,77	22,33	1,78	OR 27-3 V	27,00	33,00	3,00
OR 19-1.5 V	19,00	22,00	1,50	OR 27-3.2 V	27,00	33,40	3,20
OR 19-2 V	19,00	23,00	2,00	OR 27-3.5 V	27,00	34,00	3,50
OR 19-2.5 V	19,00	24,00	2,50	OR 27-4 V	27,00	35,00	4,00
OR 19-3 V	19,00	25,00	3,00	OR 27-5 V	27,00	37,00	5,00
OR 19-4 V	19,00	27,00	4,00	OR 27.3-2.4 V	27,30	32,10	2,40
OR 19.2-3 V	19,20	25,20	3,00	OR 27.8-3.6 V	27,80	35,00	3,60
OR 19.3-2.4 V	19,30	24,10	2,40	OR 28-1.5 V	28,00	31,00	1,50
OR 19.5-3 V	19,50	25,50	3,00	OR 28-2 V	28,00	32,00	2,00
OR 19.6-2.4 V	19,60	24,40	2,40	OR 28-2.5 V	28,00	33,00	2,50
OR 19.8-3.6 V	19,80	27,00	3,60	OR 28-3 V	28,00	34,00	3,00
OR 20-1.5 V	20,00	23,00	1,50	OR 28-3.5 V	28,00	35,00	3,50
OR 20-2 V	20,00	24,00	2,00	OR 28-4 V	28,00	36,00	4,00
OR 20-2.5 V	20,00	25,00	2,50	OR 28-5 V	28,00	38,00	5,00
OR 20-3 V	20,00	26,00	3,00	OR 28.17-3.53 V	28,17	35,23	3,53
OR 20-3.5 V	20,00	27,00	3,50	OR 28.25-2.62 V	28,25	33,49	2,62
OR 20-4 V	20,00	28,00	4,00	OR 28.3-1.78 V	28,30	31,86	1,78
OR 20-5 V	20,00	30,00	5,00	OR 29-2 V	29,00	33,00	2,00
OR 20.22-3.53 V	20,22	27,28	3,53	OR 29-3 V	29,00	35,00	3,00
OR 20.29-2.62 V	20,29	25,53	2,62	OR 29-3.5 V	29,00	36,00	3,50
OR 20.3-2.4 V	20,30	25,10	2,40	OR 29.1-2.55 V	29,10	34,20	2,55
OR 20.3-2.62 V	20,30	25,54	2,62	OR 29.51-5.34 V	29,51	40,19	5,34
OR 20.35-1.78 V	20,35	23,91	1,78	OR 29.75-3.53 V	29,75	36,81	3,53
OR 20.39-1.78 V	20,39	23,95	1,78	OR 29.82-2.62 V	29,82	35,06	2,62
OR 20.5-2 V	20,50	24,50	2,00	OR 29.87-1.78 V	29,87	33,43	1,78
OR 20.5-2.4 V	20,50	25,30	2,40	OR 30-1 V	30,00	32,00	1,00
OR 21-2 V	21,00	25,00	2,00	OR 30-1.5 V	30,00	33,00	1,50
OR 21-3 V	21,00	27,00	3,00	OR 30-2 V	30,00	34,00	2,00
OR 21.1-1.6 V	21,10	24,30	1,60	OR 30-2.5 V	30,00	35,00	2,50
OR 21.5-2.4 V	21,50	26,30	2,40	OR 30-3 V	30,00	36,00	3,00
OR 21.82-3.53 V	21,82	28,88	3,53	OR 30-3.5 V	30,00	37,00	3,50
OR 21.89-2.62 V	21,89	27,13	2,62	OR 30-4 V	30,00	38,00	4,00
OR 21.95-1.78 V	21,95	25,51	1,78	OR 30-5 V	30,00	40,00	5,00
OR 22-1.5 V	22,00	25,00	1,50	OR 30-6 V	30,00	42,00	6,00
OR 22-2 V	22,00	26,00	2,00	OR 30.2-3 V	30,20	36,20	3,00
OR 22-2.5 V	22,00	27,00	2,50	OR 31-2 V	31,00	35,00	2,00
OR 22-2.62 V	22,00	27,24	2,62	OR 31-3 V	31,00	37,00	3,00
OR 22-3 V	22,00	28,00	3,00	OR 31.12-5.34 V	31,12	41,80	5,34
OR 22-3.5 V	22,00	29,00	3,50	OR 31.34-3.53 V	31,34	38,40	3,53
OR 22-4 V	22,00	30,00	4,00	OR 31.42-2.62 V	31,42	36,66	2,62
OR 22-5 V	22,00	32,00	5,00	OR 31.47-1.78 V	31,47	35,03	1,78
OR 22.2-3 V	22,20	28,20	3,00	OR 31.5-3 V	31,50	37,50	3,00
OR 22.3-2.4 V	22,30	27,10	2,40	OR 32-2 V	32,00	36,00	2,00
OR 23-2 V	23,00	27,00	2,00	OR 32-2.5 V	32,00	37,00	2,50
OR 23-2.5 V	23,00	28,00	2,50	OR 32-3 V	32,00	38,00	3,00
OR 23-3 V	23,00	29,00	3,00	OR 32-3.5 V	32,00	39,00	3,50
OR 23-4 V	23,00	31,00	4,00	OR 32-4 V	32,00	40,00	4,00
OR 23.3-2.4 V	23,30	28,10	2,40	OR 32.2-3 V	32,20	38,20	3,00
OR 23.39-3.53 V	23,39	30,45	3,53	OR 32.92-3.53 V	32,92	39,98	3,53
OR 23.4-3.53 V	23,40	30,46	3,53	OR 32.99-2.62 V	32,99	38,23	2,62
OR 23.47-2.62 V	23,47	28,71	2,62	OR 33-2 V	33,00	37,00	2,00
OR 23.47-2.95 V	23,47	29,37	2,95	OR 33-2.62 V	33,00	38,24	2,62
OR 23.5-3 V	23,50	29,50	3,00	OR 33-3.5 V	33,00	40,00	3,50
OR 23.52-1.78 V	23,52	27,08	1,78	OR 33.05-1.78 V	33,05	36,61	1,78
OR 23.53-1.78 V	23,53	27,09	1,78	OR 33.3-2.4 V	33,30	38,10	2,40
OR 24-1.5 V	24,00	27,00	1,50	OR 34-1.5 V	34,00	37,00	1,50
OR 24-2 V	24,00	28,00	2,00	OR 34-2 V	34,00	38,00	2,00
OR 24-2.5 V	24,00	29,00	2,50	OR 34-2.5 V	34,00	39,00	2,50
OR 24-3 V	24,00	30,00	3,00	OR 34-3 V	34,00	40,00	3,00
OR 24-4 V	24,00	32,00	4,00	OR 34-4 V	34,00	42,00	4,00
OR 24-5 V	24,00	34,00	5,00	OR 34-5 V	34,00	44,00	5,00
OR 24.2-3 V	24,20	30,20	3,00	OR 34.2-3 V	34,20	40,20	3,00
OR 24.5-1.5 V	24,50	27,50	1,50	OR 34.29-5.34 V	34,29	44,97	5,34
OR 24.6-3.6 V	24,60	31,80	3,60	OR 34.52-3.53 V	34,52	41,58	3,53
OR 24.99-3.53 V	24,99	32,05	3,53	OR 34.59-2.62 V	34,59	39,83	2,62
OR 25-2 V	25,00	29,00	2,00	OR 34.65-1.78 V	34,65	38,21	1,78
OR 25-2.4 V	25,00	29,80	2,40	OR 35-1 V	35,00	37,00	1,00

Web: <http://cat.hansa-flex.com/en/OR80SHOREFPM>

(Continued)

OR 80° Shore FPM

## O-ring 80SH FKM (FPM)

Identification	d1 mm	d2 mm	s mm	Identification	d1 mm	d2 mm	s mm
OR 35-2 V	35,00	39,00	2,00	OR 47.62-3.53 V	47,62	54,68	3,53
OR 35-2.5 V	35,00	40,00	2,50	OR 47.63-3.53 V	47,63	54,69	3,53
OR 35-3 V	35,00	41,00	3,00	OR 48-2 V	48,00	52,00	2,00
OR 35-4 V	35,00	43,00	4,00	OR 48-3 V	48,00	54,00	3,00
OR 35-5 V	35,00	45,00	5,00	OR 48-3.5 V	48,00	55,00	3,50
OR 35-6 V	35,00	47,00	6,00	OR 48-4 V	48,00	56,00	4,00
OR 35.2-3 V	35,20	41,20	3,00	OR 48-5 V	48,00	58,00	5,00
OR 35.6-3.6 V	35,60	42,80	3,60	OR 48.9-2.62 V	48,90	54,14	2,62
OR 36-2 V	36,00	40,00	2,00	OR 49-3 V	49,00	55,00	3,00
OR 36-2.5 V	36,00	41,00	2,50	OR 49.2-3.53 V	49,20	56,26	3,53
OR 36-3 V	36,00	42,00	3,00	OR 49.2-5.7 V	49,20	60,60	5,70
OR 36-3.5 V	36,00	43,00	3,50	OR 49.21-3.53 V	49,21	56,27	3,53
OR 36-5 V	36,00	46,00	5,00	OR 49.3-5.7 V	49,30	60,70	5,70
OR 36.09-3.53 V	36,09	43,15	3,53	OR 49.5-3 V	49,50	55,50	3,00
OR 36.17-2.62 V	36,17	41,41	2,62	OR 50-2 V	50,00	54,00	2,00
OR 36.2-3 V	36,20	42,20	3,00	OR 50-2.5 V	50,00	55,00	2,50
OR 36.27-1.78 V	36,27	39,83	1,78	OR 50-3 V	50,00	56,00	3,00
OR 37-2 V	37,00	41,00	2,00	OR 50-4 V	50,00	58,00	4,00
OR 37-2.5 V	37,00	42,00	2,50	OR 50-5 V	50,00	60,00	5,00
OR 37-3 V	37,00	43,00	3,00	OR 50-6 V	50,00	62,00	6,00
OR 37-4 V	37,00	45,00	4,00	OR 50.16-5.33 V	50,16	60,82	5,33
OR 37.47-5.33 V	37,47	48,13	5,33	OR 50.17-5.34 V	50,17	60,85	5,34
OR 37.47-5.34 V	37,47	48,15	5,34	OR 50.39-3.53 V	50,39	57,45	3,53
OR 37.69-3.53 V	37,69	44,75	3,53	OR 50.4-3.53 V	50,40	57,46	3,53
OR 37.77-2.62 V	37,77	43,01	2,62	OR 50.47-2.62 V	50,47	55,71	2,62
OR 37.82-1.78 V	37,82	41,38	1,78	OR 50.52-1.78 V	50,52	54,08	1,78
OR 38-2 V	38,00	42,00	2,00	OR 50.8-3.53 V	50,80	57,86	3,53
OR 38-2.5 V	38,00	43,00	2,50	OR 51-2 V	51,00	55,00	2,00
OR 38-3 V	38,00	44,00	3,00	OR 52-1.5 V	52,00	55,00	1,50
OR 38-4 V	38,00	46,00	4,00	OR 52-2.5 V	52,00	57,00	2,50
OR 39-2 V	39,00	43,00	2,00	OR 52-3 V	52,00	58,00	3,00
OR 39-3.5 V	39,00	46,00	3,50	OR 52-3.5 V	52,00	59,00	3,50
OR 39-4 V	39,00	47,00	4,00	OR 52-4 V	52,00	60,00	4,00
OR 39.2-3 V	39,20	45,20	3,00	OR 52-5 V	52,00	62,00	5,00
OR 39.2-5.7 V	39,20	50,60	5,70	OR 52-6 V	52,00	64,00	6,00
OR 39.34-2.62 V	39,34	44,58	2,62	OR 52.07-2.62 V	52,07	57,31	2,62
OR 39.7-3.53 V	39,70	46,76	3,53	OR 52.4-3.53 V	52,40	59,46	3,53
OR 40-2 V	40,00	44,00	2,00	OR 53-2 V	53,00	57,00	2,00
OR 40-2.5 V	40,00	45,00	2,50	OR 53-3 V	53,00	59,00	3,00
OR 40-3 V	40,00	46,00	3,00	OR 53-4 V	53,00	61,00	4,00
OR 40-3.5 V	40,00	47,00	3,50	OR 53-5 V	53,00	63,00	5,00
OR 40-4 V	40,00	48,00	4,00	OR 53.09-3 V	53,09	59,09	3,00
OR 40-5 V	40,00	50,00	5,00	OR 53.34-5.34 V	53,34	64,02	5,34
OR 40.64-5.34 V	40,64	51,32	5,34	OR 53.57-3.53 V	53,57	60,63	3,53
OR 40.65-5.33 V	40,65	51,31	5,33	OR 53.64-2.62 V	53,64	58,88	2,62
OR 40.87-3.53 V	40,87	47,93	3,53	OR 53.7-1.78 V	53,70	57,26	1,78
OR 40.94-2.62 V	40,94	46,18	2,62	OR 53.97-3.53 V	53,97	61,03	3,53
OR 40.95-2.62 V	40,95	46,19	2,62	OR 54-2 V	54,00	58,00	2,00
OR 41-1.78 V	41,00	44,56	1,78	OR 54-2.5 V	54,00	59,00	2,50
OR 41.28-3.53 V	41,28	48,34	3,53	OR 54-3 V	54,00	60,00	3,00
OR 42-2 V	42,00	46,00	2,00	OR 54-4 V	54,00	62,00	4,00
OR 42-2.5 V	42,00	47,00	2,50	OR 54.2-5.7 V	54,20	65,60	5,70
OR 42-3 V	42,00	48,00	3,00	OR 54.3-5.7 V	54,30	65,70	5,70
OR 42-4 V	42,00	50,00	4,00	OR 55-2 V	55,00	59,00	2,00
OR 42-5 V	42,00	52,00	5,00	OR 55-2.5 V	55,00	60,00	2,50
OR 42.52-2.62 V	42,52	47,76	2,62	OR 55-3 V	55,00	61,00	3,00
OR 42.86-3.53 V	42,86	49,92	3,53	OR 55-3.5 V	55,00	62,00	3,50
OR 43-2 V	43,00	47,00	2,00	OR 55-4 V	55,00	63,00	4,00
OR 43-3 V	43,00	49,00	3,00	OR 55-5 V	55,00	65,00	5,00
OR 43.5-3 V	43,50	49,50	3,00	OR 55-6 V	55,00	67,00	6,00
OR 43.82-5.33 V	43,82	54,48	5,33	OR 55.25-2.62 V	55,25	60,49	2,62
OR 43.82-5.34 V	43,82	54,50	5,34	OR 55.56-3.53 V	55,56	62,62	3,53
OR 44-2 V	44,00	48,00	2,00	OR 56-2 V	56,00	60,00	2,00
OR 44-3 V	44,00	50,00	3,00	OR 56-2.5 V	56,00	61,00	2,50
OR 44-4 V	44,00	52,00	4,00	OR 56-3 V	56,00	62,00	3,00
OR 44.04-3.53 V	44,04	51,10	3,53	OR 56-4 V	56,00	64,00	4,00
OR 44.12-2.62 V	44,12	49,36	2,62	OR 56.52-5.33 V	56,52	67,18	5,33
OR 44.17-1.78 V	44,17	47,73	1,78	OR 56.52-5.34 V	56,52	67,20	5,34
OR 44.3-5.7 V	44,30	55,70	5,70	OR 56.74-3.53 V	56,74	63,80	3,53
OR 44.45-3.53 V	44,45	51,51	3,53	OR 56.82-2.62 V	56,82	62,06	2,62
OR 45-1.5 V	45,00	48,00	1,50	OR 56.87-1.78 V	56,87	60,43	1,78
OR 45-2 V	45,00	49,00	2,00	OR 57-3 V	57,00	63,00	3,00
OR 45-2.5 V	45,00	50,00	2,50	OR 57-4 V	57,00	65,00	4,00
OR 45-3 V	45,00	51,00	3,00	OR 57.15-3.53 V	57,15	64,21	3,53
OR 45-4 V	45,00	53,00	4,00	OR 58-2 V	58,00	62,00	2,00
OR 45-5 V	45,00	55,00	5,00	OR 58-2.5 V	58,00	63,00	2,50
OR 45.69-2.62 V	45,69	50,93	2,62	OR 58-3 V	58,00	64,00	3,00
OR 46-2 V	46,00	50,00	2,00	OR 58-3.5 V	58,00	65,00	3,50
OR 46-3 V	46,00	52,00	3,00	OR 58.42-2.62 V	58,42	63,66	2,62
OR 46.04-3.53 V	46,04	53,10	3,53	OR 58.74-3.53 V	58,74	65,80	3,53
OR 46.99-5.34 V	46,99	57,67	5,34	OR 59.2-5.7 V	59,20	70,60	5,70
OR 47-2 V	47,00	51,00	2,00	OR 59.3-5.7 V	59,30	70,70	5,70
OR 47-2.5 V	47,00	52,00	2,50	OR 59.5-3 V	59,50	65,50	3,00
OR 47-3 V	47,00	53,00	3,00	OR 59.69-5.34 V	59,69	70,37	5,34
OR 47-4 V	47,00	55,00	4,00	OR 59.92-3.53 V	59,92	66,98	3,53
OR 47-5 V	47,00	57,00	5,00	OR 59.99-2.62 V	59,99	65,23	2,62
OR 47.22-3.53 V	47,22	54,28	3,53	OR 60-2 V	60,00	64,00	2,00
OR 47.29-2.62 V	47,29	52,53	2,62	OR 60-2.5 V	60,00	65,00	2,50
OR 47.35-1.78 V	47,35	50,91	1,78	OR 60-3 V	60,00	66,00	3,00

Web: <http://cat.hansa-flex.com/en/OR80SHOREFPM>

## OR 80° Shore FPM

(Continued)

## O-ring 80SH FKM (FPM)

Identification	d1 mm	d2 mm	s mm
OR 60-4 V	60,00	68,00	4,00
OR 60-5 V	60,00	70,00	5,00
OR 60.05-1.78 V	60,05	63,61	1,78
OR 60.32-3.53 V	60,32	67,38	3,53
OR 61-3 V	61,00	67,00	3,00
OR 61.6-2.62 V	61,60	66,84	2,62
OR 61.9-3.53 V	61,90	68,96	3,53
OR 62-2 V	62,00	66,00	2,00
OR 62-3 V	62,00	68,00	3,00
OR 62-4 V	62,00	70,00	4,00
OR 62-5 V	62,00	72,00	5,00
OR 62.2-5.7 V	62,20	73,60	5,70
OR 62.87-5.34 V	62,87	73,55	5,34
OR 63-3 V	63,00	69,00	3,00
OR 63-4 V	63,00	71,00	4,00
OR 63-5 V	63,00	73,00	5,00
OR 63-6 V	63,00	75,00	6,00
OR 63.09-3.53 V	63,09	70,15	3,53
OR 63.17-2.62 V	63,17	68,41	2,62
OR 63.22-1.78 V	63,22	66,78	1,78
OR 63.5-3.53 V	63,50	70,56	3,53
OR 64-3 V	64,00	70,00	3,00
OR 64.3-5.7 V	64,30	75,70	5,70
OR 64.5-3 V	64,50	70,50	3,00
OR 64.77-2.62 V	64,77	70,01	2,62
OR 65-1.5 V	65,00	68,00	1,50
OR 65-2 V	65,00	69,00	2,00
OR 65-2.5 V	65,00	70,00	2,50
OR 65-3 V	65,00	71,00	3,00
OR 65-3.5 V	65,00	72,00	3,50
OR 65-4 V	65,00	73,00	4,00
OR 65-5 V	65,00	75,00	5,00
OR 65-6 V	65,00	77,00	6,00
OR 65.1-3.53 V	65,10	72,16	3,53
OR 66-3 V	66,00	72,00	3,00
OR 66-6 V	66,00	78,00	6,00
OR 66.04-5.34 V	66,04	76,72	5,34
OR 66.27-3.53 V	66,27	73,33	3,53
OR 66.34-2.62 V	66,34	71,58	2,62
OR 66.4-1.78 V	66,40	69,96	1,78
OR 66.67-3.53 V	66,67	73,73	3,53
OR 67.95-2.62 V	67,95	73,19	2,62
OR 68-2 V	68,00	72,00	2,00
OR 68-3 V	68,00	74,00	3,00
OR 68-4 V	68,00	76,00	4,00
OR 68-5 V	68,00	78,00	5,00
OR 68.26-3.53 V	68,26	75,32	3,53
OR 69.22-5.34 V	69,22	79,90	5,34
OR 69.3-5.7 V	69,30	80,70	5,70
OR 69.44-3.53 V	69,44	76,50	3,53
OR 69.52-2.62 V	69,52	74,76	2,62
OR 69.57-1.78 V	69,57	73,13	1,78
OR 69.85-3.53 V	69,85	76,91	3,53
OR 70-2 V	70,00	74,00	2,00
OR 70-2.5 V	70,00	75,00	2,50
OR 70-3 V	70,00	76,00	3,00
OR 70-3.5 V	70,00	77,00	3,50
OR 70-4 V	70,00	78,00	4,00
OR 70-5 V	70,00	80,00	5,00
OR 70-6 V	70,00	82,00	6,00
OR 71.12-2.62 V	71,12	76,36	2,62
OR 71.44-3.53 V	71,44	78,50	3,53
OR 72-2 V	72,00	76,00	2,00
OR 72-2.5 V	72,00	77,00	2,50
OR 72-3 V	72,00	78,00	3,00
OR 72-4 V	72,00	80,00	4,00
OR 72-5 V	72,00	82,00	5,00
OR 72.39-5.34 V	72,39	83,07	5,34
OR 72.62-3.53 V	72,62	79,68	3,53
OR 72.69-2.62 V	72,69	77,93	2,62
OR 72.75-1.78 V	72,75	76,31	1,78
OR 73-3.5 V	73,00	80,00	3,50
OR 73-5 V	73,00	83,00	5,00
OR 73-7 V	73,00	87,00	7,00
OR 73.02-3.53 V	73,02	80,08	3,53
OR 74-1.5 V	74,00	77,00	1,50
OR 74-2 V	74,00	78,00	2,00
OR 74-3 V	74,00	80,00	3,00
OR 74-4 V	74,00	82,00	4,00
OR 74-5 V	74,00	84,00	5,00
OR 74.3-5.7 V	74,30	85,70	5,70
OR 74.6-3.53 V	74,60	81,66	3,53
OR 74.63-5.34 V	74,63	85,31	5,34
OR 75-2 V	75,00	79,00	2,00
OR 75-2.5 V	75,00	80,00	2,50
OR 75-3 V	75,00	81,00	3,00
OR 75-4 V	75,00	83,00	4,00
OR 75-5 V	75,00	85,00	5,00
OR 75-6 V	75,00	87,00	6,00

Identification	d1 mm	d2 mm	s mm
OR 75.57-5.34 V	75,57	86,25	5,34
OR 75.79-3.53 V	75,79	82,85	3,53
OR 75.87-2.62 V	75,87	81,11	2,62
OR 75.92-1.78 V	75,92	79,48	1,78
OR 76-2 V	76,00	80,00	2,00
OR 76-2.5 V	76,00	81,00	2,50
OR 76-3 V	76,00	82,00	3,00
OR 78-2 V	78,00	82,00	2,00
OR 78-3 V	78,00	84,00	3,00
OR 78-4 V	78,00	86,00	4,00
OR 78.74-5.33 V	78,74	89,40	5,33
OR 78.74-5.34 V	78,74	89,42	5,34
OR 78.97-3.53 V	78,97	86,03	3,53
OR 79-3 V	79,00	85,00	3,00
OR 79-7 V	79,00	93,00	7,00
OR 79.2-5.7 V	79,20	90,60	5,70
OR 79.3-5.7 V	79,30	90,70	5,70
OR 79.5-3 V	79,50	85,50	3,00
OR 79.73-5.34 V	79,73	90,41	5,34
OR 80-3 V	80,00	86,00	3,00
OR 80-3.5 V	80,00	87,00	3,50
OR 80-4 V	80,00	88,00	4,00
OR 80-5 V	80,00	90,00	5,00
OR 81-4 V	81,00	89,00	4,00
OR 81.92-5.34 V	81,92	92,60	5,34
OR 82-2.5 V	82,00	87,00	2,50
OR 82-3 V	82,00	88,00	3,00
OR 82-4 V	82,00	90,00	4,00
OR 82.14-3.53 V	82,14	89,20	3,53
OR 82.22-2.62 V	82,22	87,46	2,62
OR 84-3 V	84,00	90,00	3,00
OR 84-4 V	84,00	92,00	4,00
OR 84-5 V	84,00	94,00	5,00
OR 84.3-5.7 V	84,30	95,70	5,70
OR 84.5-3 V	84,50	90,50	3,00
OR 85-2 V	85,00	89,00	2,00
OR 85-2.5 V	85,00	90,00	2,50
OR 85-3 V	85,00	91,00	3,00
OR 85-3.5 V	85,00	92,00	3,50
OR 85-4 V	85,00	93,00	4,00
OR 85-5 V	85,00	95,00	5,00
OR 85-6 V	85,00	97,00	6,00
OR 85.09-5.33 V	85,09	95,75	5,33
OR 85.09-5.34 V	85,09	95,77	5,34
OR 85.32-3.53 V	85,32	92,38	3,53
OR 86-4 V	86,00	94,00	4,00
OR 87-4 V	87,00	95,00	4,00
OR 87-5 V	87,00	97,00	5,00
OR 88-4 V	88,00	96,00	4,00
OR 88-5 V	88,00	98,00	5,00
OR 88-6 V	88,00	100,00	6,00
OR 88.27-5.34 V	88,27	98,95	5,34
OR 88.49-3.53 V	88,49	95,55	3,53
OR 88.57-2.62 V	88,57	93,81	2,62
OR 88.62-1.78 V	88,62	92,18	1,78
OR 89-4 V	89,00	97,00	4,00
OR 89.2-5.7 V	89,20	100,60	5,70
OR 89.3-5.7 V	89,30	100,70	5,70
OR 89.5-3 V	89,50	95,50	3,00
OR 89.69-5.34 V	89,69	100,37	5,34
OR 90-2 V	90,00	94,00	2,00
OR 90-2.5 V	90,00	95,00	2,50
OR 90-3 V	90,00	96,00	3,00
OR 90-4 V	90,00	98,00	4,00
OR 90-5 V	90,00	100,00	5,00
OR 90-7 V	90,00	104,00	7,00
OR 91.44-5.34 V	91,44	102,12	5,34
OR 91.67-3.53 V	91,67	98,73	3,53
OR 92-3 V	92,00	98,00	3,00
OR 92-4 V	92,00	100,00	4,00
OR 93-5 V	93,00	103,00	5,00
OR 94-2.5 V	94,00	99,00	2,50
OR 94.3-5.7 V	94,30	105,70	5,70
OR 94.5-3 V	94,50	100,50	3,00
OR 94.62-5.34 V	94,62	105,30	5,34
OR 94.84-3.53 V	94,84	101,90	3,53
OR 94.92-2.62 V	94,92	100,16	2,62
OR 94.97-1.78 V	94,97	98,53	1,78
OR 95-3 V	95,00	101,00	3,00
OR 97-3 V	97,00	103,00	3,00
OR 97.79-5.34 V	97,79	108,47	5,34
OR 98-3 V	98,00	104,00	3,00
OR 98.02-3.53 V	98,02	105,08	3,53
OR 99.3-5.7 V	99,30	110,70	5,70
OR 100-3 V	100,00	106,00	3,00
OR 100-3.5 V	100,00	107,00	3,50
OR 100-4 V	100,00	108,00	4,00
OR 100-5 V	100,00	110,00	5,00
OR 100-5.34 V	100,00	110,68	5,34

Web: <http://cat.hansa-flex.com/en/OR80SHOREFPM>

(Continued)

OR 80° Shore FPM

O-ring 80SH FKM (FPM)

Identification	d1 mm	d2 mm	s mm	Identification	d1 mm	d2 mm	s mm
OR 100-7 V	100,00	114,00	7,00	OR 139.07-5.34 V	139,07	149,75	5,34
OR 100.97-5.34 V	100,97	111,65	5,34	OR 139.07-7 V	139,07	153,07	7,00
OR 101.19-3.53 V	101,19	108,25	3,53	OR 139.29-3.53 V	139,29	146,35	3,53
OR 102-4 V	102,00	110,00	4,00	OR 139.3-5.7 V	139,30	150,70	5,70
OR 103-4 V	103,00	111,00	4,00	OR 139.5-3 V	139,50	145,50	3,00
OR 104-3 V	104,00	110,00	3,00	OR 140-3 V	140,00	146,00	3,00
OR 104.14-5.34 V	104,14	114,82	5,34	OR 140-4 V	140,00	148,00	4,00
OR 104.3-5.7 V	104,30	115,70	5,70	OR 142.24-5.34 V	142,24	152,92	5,34
OR 104.37-3.53 V	104,37	111,43	3,53	OR 142.24-7 V	142,24	156,24	7,00
OR 105-3.5 V	105,00	112,00	3,50	OR 142.47-3.53 V	142,47	149,53	3,53
OR 105-5 V	105,00	115,00	5,00	OR 142.88-5.34 V	142,88	153,56	5,34
OR 106-3.5 V	106,00	113,00	3,50	OR 144.3-5.7 V	144,30	155,70	5,70
OR 106-5 V	106,00	116,00	5,00	OR 145.42-5.34 V	145,42	156,10	5,34
OR 107-2.5 V	107,00	112,00	2,50	OR 145.42-7 V	145,42	159,42	7,00
OR 107.32-5.34 V	107,32	118,00	5,34	OR 145.64-3.53 V	145,64	152,70	3,53
OR 107.54-3.53 V	107,54	114,60	3,53	OR 146.05-5.34 V	146,05	156,73	5,34
OR 107.62-2.62 V	107,62	112,86	2,62	OR 148-5 V	148,00	158,00	5,00
OR 109.3-5.7 V	109,30	120,70	5,70	OR 148.59-5.34 V	148,59	159,27	5,34
OR 109.54-5.34 V	109,54	120,22	5,34	OR 148.59-7 V	148,59	162,59	7,00
OR 110-5 V	110,00	120,00	5,00	OR 148.82-3.53 V	148,82	155,88	3,53
OR 110.49-5.34 V	110,49	121,17	5,34	OR 149.23-5.34 V	149,23	159,91	5,34
OR 110.72-3.53 V	110,72	117,78	3,53	OR 149.3-5.7 V	149,30	160,70	5,70
OR 112-3 V	112,00	118,00	3,00	OR 150-3 V	150,00	156,00	3,00
OR 113-3 V	113,00	119,00	3,00	OR 150-4 V	150,00	158,00	4,00
OR 113.67-5.34 V	113,67	124,35	5,34	OR 150-5 V	150,00	160,00	5,00
OR 113.67-7 V	113,67	127,67	7,00	OR 150-6 V	150,00	162,00	6,00
OR 113.89-3.53 V	113,89	120,95	3,53	OR 151.77-5.34 V	151,77	162,45	5,34
OR 113.97-2.62 V	113,97	119,21	2,62	OR 151.77-7 V	151,77	165,77	7,00
OR 114-1.78 V	114,00	117,56	1,78	OR 151.99-3.53 V	151,99	159,05	3,53
OR 114-3 V	114,00	120,00	3,00	OR 154.3-5.7 V	154,30	165,70	5,70
OR 114.3-5.7 V	114,30	125,70	5,70	OR 155-3 V	155,00	161,00	3,00
OR 114.5-3 V	114,50	120,50	3,00	OR 155-5 V	155,00	165,00	5,00
OR 115-2 V	115,00	119,00	2,00	OR 155-5.34 V	155,00	165,68	5,34
OR 115-3 V	115,00	121,00	3,00	OR 156-4 V	156,00	164,00	4,00
OR 115-5 V	115,00	125,00	5,00	OR 158.12-5.34 V	158,12	168,80	5,34
OR 116-5 V	116,00	126,00	5,00	OR 158.12-7 V	158,12	172,12	7,00
OR 116.84-5.34 V	116,84	127,52	5,34	OR 158.34-3.53 V	158,34	165,40	3,53
OR 116.84-7 V	116,84	130,84	7,00	OR 159.3-5.7 V	159,30	170,70	5,70
OR 117.07-3.53 V	117,07	124,13	3,53	OR 160-3 V	160,00	166,00	3,00
OR 117.48-5.34 V	117,48	128,16	5,34	OR 160-4 V	160,00	168,00	4,00
OR 119-3 V	119,00	125,00	3,00	OR 160-5 V	160,00	170,00	5,00
OR 119-3.5 V	119,00	126,00	3,50	OR 160-7 V	160,00	174,00	7,00
OR 119.3-5.7 V	119,30	130,70	5,70	OR 161.3-5.34 V	161,30	171,98	5,34
OR 119.5-3 V	119,50	125,50	3,00	OR 161.9-7 V	161,90	175,90	7,00
OR 120-3 V	120,00	126,00	3,00	OR 162-5 V	162,00	172,00	5,00
OR 120-3.5 V	120,00	127,00	3,50	OR 164-3 V	164,00	170,00	3,00
OR 120-4 V	120,00	128,00	4,00	OR 164-4 V	164,00	172,00	4,00
OR 120-5 V	120,00	130,00	5,00	OR 164.3-5.7 V	164,30	175,70	5,70
OR 120.02-5.34 V	120,02	130,70	5,34	OR 164.47-5.34 V	164,47	175,15	5,34
OR 120.02-7 V	120,02	134,02	7,00	OR 164.47-7 V	164,47	178,47	7,00
OR 120.24-3.53 V	120,24	127,30	3,53	OR 164.69-3.53 V	164,69	171,75	3,53
OR 120.32-2.62 V	120,32	125,56	2,62	OR 165-4 V	165,00	173,00	4,00
OR 120.65-5.34 V	120,65	131,33	5,34	OR 165-6 V	165,00	177,00	6,00
OR 123.19-5.34 V	123,19	133,87	5,34	OR 167.7-5.34 V	167,70	178,38	5,34
OR 123.19-7 V	123,19	137,19	7,00	OR 168-5 V	168,00	178,00	5,00
OR 123.42-3.53 V	123,42	130,48	3,53	OR 169.3-5.7 V	169,30	180,70	5,70
OR 123.44-1.78 V	123,44	127,00	1,78	OR 170-3.55 V	170,00	177,10	3,55
OR 123.83-5.34 V	123,83	134,51	5,34	OR 170-5 V	170,00	180,00	5,00
OR 124.3-5.7 V	124,30	135,70	5,70	OR 170.82-5.34 V	170,82	181,50	5,34
OR 125-2.5 V	125,00	130,00	2,50	OR 170.82-7 V	170,82	184,82	7,00
OR 125-3 V	125,00	131,00	3,00	OR 171.04-3.53 V	171,04	178,10	3,53
OR 125-5 V	125,00	135,00	5,00	OR 172-4 V	172,00	180,00	4,00
OR 126.37-5.34 V	126,37	137,05	5,34	OR 174-5.34 V	174,00	184,68	5,34
OR 126.37-7 V	126,37	140,37	7,00	OR 174.3-5.7 V	174,30	185,70	5,70
OR 126.59-3.53 V	126,59	133,65	3,53	OR 177.17-5.34 V	177,17	187,85	5,34
OR 126.67-2.62 V	126,67	131,91	2,62	OR 177.17-7 V	177,17	191,17	7,00
OR 127-5.34 V	127,00	137,68	5,34	OR 177.39-3.53 V	177,39	184,45	3,53
OR 128-2.5 V	128,00	133,00	2,50	OR 179.3-5.7 V	179,30	190,70	5,70
OR 128-3 V	128,00	134,00	3,00	OR 180-3 V	180,00	186,00	3,00
OR 129.3-5.7 V	129,30	140,70	5,70	OR 180-4 V	180,00	188,00	4,00
OR 129.54-5.34 V	129,54	140,22	5,34	OR 183.52-5.34 V	183,52	194,20	5,34
OR 129.54-7 V	129,54	143,54	7,00	OR 183.52-7 V	183,52	197,52	7,00
OR 129.77-3.53 V	129,77	136,83	3,53	OR 183.74-3.53 V	183,74	190,80	3,53
OR 130.18-5.34 V	130,18	140,86	5,34	OR 183.82-2.62 V	183,82	189,06	2,62
OR 132-3 V	132,00	138,00	3,00	OR 184.3-5.7 V	184,30	195,70	5,70
OR 132-4 V	132,00	140,00	4,00	OR 185-3 V	185,00	191,00	3,00
OR 132.72-7 V	132,72	146,72	7,00	OR 189.3-5.7 V	189,30	200,70	5,70
OR 132.79-5.34 V	132,79	143,47	5,34	OR 189.87-5.34 V	189,87	200,55	5,34
OR 132.94-3.53 V	132,94	140,00	3,53	OR 189.87-7 V	189,87	203,87	7,00
OR 133.35-5.34 V	133,35	144,03	5,34	OR 190.09-3.53 V	190,09	197,15	3,53
OR 134.3-5.7 V	134,30	145,70	5,70	OR 194.3-5.7 V	194,30	205,70	5,70
OR 134.5-3 V	134,50	140,50	3,00	OR 195-4 V	195,00	203,00	4,00
OR 135-3 V	135,00	141,00	3,00	OR 196-4 V	196,00	204,00	4,00
OR 135-4 V	135,00	143,00	4,00	OR 196.22-5.34 V	196,22	206,90	5,34
OR 135.89-5.34 V	135,89	146,57	5,34	OR 196.22-7 V	196,22	210,22	7,00
OR 135.89-7 V	135,89	149,89	7,00	OR 196.44-3.53 V	196,44	203,50	3,53
OR 136.12-3.53 V	136,12	143,18	3,53	OR 199.3-5.7 V	199,30	210,70	5,70
OR 136.53-5.34 V	136,53	147,21	5,34	OR 200-3 V	200,00	206,00	3,00
OR 137-3 V	137,00	143,00	3,00	OR 202.57-5.34 V	202,57	213,25	5,34

Web: <http://cat.hansa-flex.com/en/OR80SHOREFPM>

**OR 80° Shore FPM**

(Continued)

**O-ring 80SH FKM (FPM)**

Identification	d1 mm	d2 mm	s mm
OR 202.57-7 V	202,57	216,57	7,00
OR 202.79-3.53 V	202,79	209,85	3,53
OR 205-4 V	205,00	213,00	4,00
OR 208.92-5.34 V	208,92	219,60	5,34
OR 208.92-7 V	208,92	222,92	7,00
OR 209.14-3.53 V	209,14	216,20	3,53
OR 209.3-5.7 V	209,30	220,70	5,70
OR 210-5 V	210,00	220,00	5,00
OR 210-6 V	210,00	222,00	6,00
OR 215-3 V	215,00	221,00	3,00
OR 215.27-5.34 V	215,27	225,95	5,34
OR 215.27-7 V	215,27	229,27	7,00
OR 215.49-3.53 V	215,49	222,55	3,53
OR 219.3-5.7 V	219,30	230,70	5,70
OR 221.62-5.34 V	221,62	232,30	5,34
OR 221.84-3.53 V	221,84	228,90	3,53
OR 227.97-5.34 V	227,97	238,65	5,34
OR 227.97-7 V	227,97	241,97	7,00
OR 228.19-3.53 V	228,19	235,25	3,53
OR 230-3 V	230,00	236,00	3,00
OR 234.32-5.34 V	234,32	245,00	5,34
OR 234.54-3.53 V	234,54	241,60	3,53
OR 238-3 V	238,00	244,00	3,00
OR 240-3 V	240,00	246,00	3,00
OR 240-4 V	240,00	248,00	4,00
OR 240-5 V	240,00	250,00	5,00
OR 240.67-5.34 V	240,67	251,35	5,34
OR 240.67-7 V	240,67	254,67	7,00
OR 240.89-3.53 V	240,89	247,95	3,53
OR 243-4 V	243,00	251,00	4,00
OR 243-5 V	243,00	253,00	5,00
OR 245-5 V	245,00	255,00	5,00
OR 247-3.5 V	247,00	254,00	3,50

Identification	d1 mm	d2 mm	s mm
OR 247-7 V	247,00	261,00	7,00
OR 247.02-5.34 V	247,02	257,70	5,34
OR 247.26-3.53 V	247,26	254,32	3,53
OR 250-4 V	250,00	258,00	4,00
OR 253.37-5.34 V	253,37	264,05	5,34
OR 253.37-7 V	253,37	267,37	7,00
OR 253.59-3.53 V	253,59	260,65	3,53
OR 255-4 V	255,00	263,00	4,00
OR 255-5 V	255,00	265,00	5,00
OR 260-3 V	260,00	266,00	3,00
OR 266.07-5.34 V	266,07	276,75	5,34
OR 266.07-7 V	266,07	280,07	7,00
OR 266.29-3.53 V	266,29	273,35	3,53
OR 278.77-5.34 V	278,77	289,45	5,34
OR 278.77-7 V	278,77	292,77	7,00
OR 278.99-3.53 V	278,99	286,05	3,53
OR 280-5 V	280,00	290,00	5,00
OR 290-5 V	290,00	300,00	5,00
OR 291.47-7 V	291,47	305,47	7,00
OR 291.69-3.53 V	291,69	298,75	3,53
OR 304.16-5.34 V	304,16	314,84	5,34
OR 304.17-7 V	304,17	318,17	7,00
OR 310.5-7 V	310,50	324,50	7,00
OR 329.57-5.34 V	329,57	340,25	5,34
OR 330-4 V	330,00	338,00	4,00
OR 345-3 V	345,00	351,00	3,00
OR 345-5 V	345,00	355,00	5,00
OR 347-5 V	347,00	357,00	5,00
OR 360-5 V	360,00	370,00	5,00
OR 375-6 V	375,00	387,00	6,00
OR 379.3-5.7 V	379,30	390,70	5,70
OR 740-6 V	740,00	752,00	6,00

**Web:** <http://cat.hansa-flex.com/en/OR80SHOREFPM>

4

**OR 70° Shore EPDM**

**O-ring 70SH EPDM sulphur cured**

**Design:** O-ring  
**Temp. min.:** -30 °C  
**Temp. max.:** 120 °C  
**Media:** HFC, HFD, steam, Air  
**Material:** EPDM sulphur cured 70 Shore

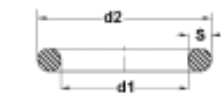

Bestellnummer / Item code	OR 16.09-3.53 V
d1 (mm) x 100	16,09 x 100
Werkstoff / Material	G (mm) x 190



Identification	d1	d2	s
	mm	mm	mm
OR 7-3 E 70S	7,00	13,00	3,00
OR 12-2 E 70S	12,00	16,00	2,00

Identification	d1	d2	s
	mm	mm	mm
OR 15-2 E 70S	15,00	19,00	2,00
OR 20-2 E 70S	20,00	24,00	2,00

**Web:** <http://cat.hansa-flex.com/en/OR70SHOREEPDM>

**OR 70° Shore Silicon**

**O-ring 70SH silicone**

**Design:** O-ring  
**Material:** Silicone 70 Shore

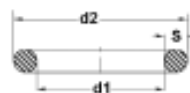

Bestellnummer / Item code	OR 36.09-3.53 S70
d1 (mm) x 100	36,09 x 100
Werkstoff / Material	S (mm) x 190



Identification	d1	d2	s
	mm	mm	mm
OR 36.09-3.53 S70	36,09	43,15	3,53
OR 266.29-3.53 S70	266,29	273,35	3,53

Identification	d1	d2	s
	mm	mm	mm
OR 304.39-3.53 S70	304,39	311,45	3,53
OR 329.57-7 S70	329,57	343,57	7,00

**Web:** <http://cat.hansa-flex.com/en/OR70SHORESILICON>

**OR F-S**

**O-ring FEP/silicone**

**Design:** O-ring  
**Material:** FEP / silicone

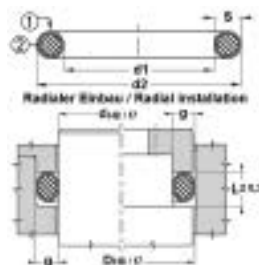

Identification	d1	d2	s
	mm	mm	mm
OR 24.99-3.53 F-S	24,99	32,05	3,53
OR 47.22-3.53 F-S	47,22	54,28	3,53

Identification	d1	d2	s
	mm	mm	mm
OR 55.56-3.53 F-S	55,56	62,62	3,53



OR F-S

(Continued)

O-ring FEP/silicone

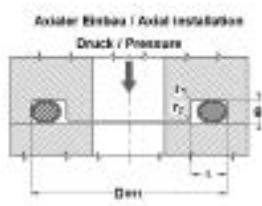

Web: <http://cat.hansa-flex.com/en/ORFS>

O-Ringschnur 70° Shore NBR

O-ring cord, 70SH NBR



**Design:** O-ring cord  
**Colour:** black  
**Temp. min.:** -35 °C  
**Temp. max.:** 100 °C  
**Media:** resistant to mineral oils and greases, Ozone, Oxygen  
**Material:** NBR 70 Shore A

Identification	S mm	Tolerance
OR SCHNUR 1.5	1,50	+/- 0.20 mm
OR SCHNUR 1.6	1,60	+/- 0.20 mm
OR SCHNUR 1.78	1,78	+/- 0.20 mm
OR SCHNUR 2	2,00	+/- 0.20 mm
OR SCHNUR 2.4	2,40	+/- 0.25 mm
OR SCHNUR 2.5	2,50	+/- 0.25 mm
OR SCHNUR 2.62	2,62	+/- 0.25 mm
OR SCHNUR 3	3,00	+/- 0.25 mm
OR SCHNUR 3.2	3,20	+/- 0.35 mm
OR SCHNUR 3.5	3,50	+/- 0.35 mm
OR SCHNUR 3.53	3,53	+/- 0.35 mm
OR SCHNUR 4	4,00	+/- 0.35 mm
OR SCHNUR 4.5	4,50	+/- 0.40 mm
OR SCHNUR 5	5,00	+/- 0.40 mm

Identification	S mm	Tolerance
OR SCHNUR 5.33	5,33	+/- 0.40 mm
OR SCHNUR 5.5	5,50	+/- 0.40 mm
OR SCHNUR 5.7	5,70	+/- 0.40 mm
OR SCHNUR 6	6,00	+/- 0.40 mm
OR SCHNUR 6.35	6,35	+/- 0.55 mm
OR SCHNUR 6.5	6,50	+/- 0.55 mm
OR SCHNUR 7	7,00	+/- 0.55 mm
OR SCHNUR 7.5	7,50	+/- 0.55 mm
OR SCHNUR 8	8,00	+/- 0.55 mm
OR SCHNUR 8.4	8,40	+/- 0.55 mm
OR SCHNUR 8.5	8,50	+/- 0.55 mm
OR SCHNUR 9	9,00	+/- 0.55 mm
OR SCHNUR 9.5	9,50	+/- 0.55 mm
OR SCHNUR 10	10,00	+/- 0.65 mm

Web: <http://cat.hansa-flex.com/en/ORINGSCHNUR70SHORENBR>

O-Ringschnur 75° Shore FPM

O-ring cord 75SH FPM



**Design:** O-ring cord  
**Colour:** black  
**Temp. min.:** -15 °C  
**Temp. max.:** 200 °C  
**Material:** FPM 75 Shore

Identification	S mm	Tolerance
OR 178 FPM 75	1,78	+/- 0.20 mm
OR 240 FPM 75	2,40	+/- 0.20 mm
OR 250 FPM 75	2,50	+/- 0.20 mm
OR 300 FPM 75	3,00	+/- 0.25 mm
OR 400 FPM 75	4,00	+/- 0.30 mm
OR 450 FPM 75	4,50	+/- 0.30 mm
OR 500 FPM 75	5,00	+/- 0.30 mm

Identification	S mm	Tolerance
OR 534 FPM 75	5,34	+/- 0.30 mm
OR 570 FPM 75	5,70	+/- 0.30 mm
OR 600 FPM 75	6,00	+/- 0.30 mm
OR 700 FPM 75	7,00	+/- 0.40 mm
OR 800 FPM 75	8,00	+/- 0.40 mm
OR 900 FPM 75	9,00	+/- 0.40 mm

Web: <http://cat.hansa-flex.com/en/ORINGSCHNUR75SHOREFPM>



**BOX A**

**Boxed set A, norm AS/BS, small**

Box A consists of 30 sizes - 340 off

- Design:** O-ring
- Construction type:** Standard AS / BS
- Colour:** Box, grey
- Temp. min.:** -30 °C
- Temp. max.:** 100 °C
- FPM temp. min.:** -15 °C
- FPM temp. max.:** 200 °C

Ø x d	Range / Quantity	Ø x d	Range / Quantity
2,98 x 1,78	20	12,37 x 2,62	15
3,68 x 1,78	20	13,95 x 2,62	15
4,48 x 1,78	20	15,54 x 2,62	18
5,28 x 1,78	20	17,13 x 2,62	18
6,07 x 1,78	20	18,72 x 2,62	18
7,68 x 1,78	20	20,28 x 2,62	5
9,25 x 1,78	20	21,88 x 2,62	5
10,82 x 1,78	15	23,47 x 2,62	5
12,42 x 1,78	15	25,06 x 3,53	5
14,09 x 1,78	10	26,62 x 3,53	5
15,69 x 1,78	10	28,22 x 3,53	5
17,18 x 1,78	5	29,88 x 3,53	5
18,77 x 1,78	5	31,48 x 3,53	5
19,18 x 2,62	15	26,58 x 3,53	5
19,78 x 2,62	15	28,17 x 3,53	5



Identification	Material	Blower
BOX A NBR90	NBR 90 Shore A	30
BOX A FPM80	FPM 80 Shore A	30
BOX A	NBR 70 Shore A	30

**Web:** <http://cat.hansa-flex.com/en/BOXA>

**BOX B**

**Boxed set B, norm AS/BS, large**

Box B consists of 24 sizes - 275 off

- Design:** O-ring
- Construction type:** Standard AS / BS
- Colour:** Box, red
- Temp. min.:** -30 °C
- Temp. max.:** 100 °C
- FPM temp. min.:** -15 °C
- FPM temp. max.:** 200 °C

Ø x d	Range / Quantity	Ø x d	Range / Quantity
28,35 x 1,78	15	34,52 x 3,53	10
31,85 x 1,78	15	38,10 x 3,53	10
35,37 x 2,62	15	37,69 x 3,53	10
38,84 x 2,62	15	40,87 x 3,53	10
39,75 x 2,62	15	40,84 x 3,53	10
39,82 x 2,62	15	47,22 x 3,53	10
41,42 x 2,62	10	56,40 x 3,53	10
43,80 x 2,62	10	37,47 x 5,34	10
44,95 x 2,62	10	40,85 x 5,34	10
48,75 x 3,53	15	43,82 x 5,34	10
51,34 x 3,53	15	47,80 x 5,34	5
52,82 x 3,53	15	50,45 x 5,34	5

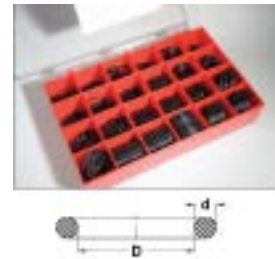

Identification	Material	Blower
BOX B NBR90	NBR 90 Shore A	24
BOX B FPM80	FPM 80 Shore A	24
BOX B	NBR 70 Shore A	24

**Web:** <http://cat.hansa-flex.com/en/BOXB>

**BOX C**

**Boxed set C, small metric**

Box C consists of 30 sizes - 425 off

- Design:** O-ring
- Construction type:** metric standard
- Colour:** Box, grey
- Temp. min.:** -30 °C
- Temp. max.:** 100 °C
- FPM temp. min.:** -15 °C
- FPM temp. max.:** 200 °C

Ø x d	Range / Quantity	Ø x d	Range / Quantity
3,00 x 1,50	20	5,08 x 2,50	15
3,90 x 1,50	20	7,08 x 2,50	15
7,90 x 1,50	20	18,90 x 2,50	15
8,90 x 1,50	20	12,00 x 3,50	15
11,80 x 1,50	20	15,00 x 3,50	15
1,60 x 2,00	20	18,00 x 3,50	10
8,80 x 2,00	20	12,00 x 3,00	10
18,80 x 2,00	20	14,08 x 3,00	10
13,80 x 2,00	20	15,08 x 3,00	10
14,80 x 2,00	20	18,08 x 3,00	10
8,30 x 2,40	15	28,20 x 3,00	5
8,30 x 2,40	15	22,20 x 3,00	5
11,30 x 2,80	15	28,20 x 2,00	5
13,30 x 2,40	15	26,20 x 3,00	5
17,30 x 2,40	15	30,20 x 3,00	5



Identification	Material	Blower
BOX C NBR90	NBR 90 Shore A	30
BOX C FPM80	FPM 80 Shore A	30
BOX C	NBR 70 Shore A	30

**Web:** <http://cat.hansa-flex.com/en/BOXC>

## BOX D

### Boxed set D, large metric

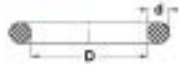

D x d	Range/Quantity	D x d	Range/Quantity
10,00 x 2,00	15	34,00 x 4,00	15
10,00 x 2,00	15	38,00 x 4,00	15
12,00 x 2,00	15	40,00 x 4,00	15
15,00 x 2,00	15	44,00 x 4,00	15
18,00 x 2,00	15	48,00 x 4,00	15
20,00 x 2,00	15	50,00 x 4,00	15
22,00 x 2,00	15	55,00 x 5,00	15
25,00 x 2,00	15	60,00 x 5,00	15
28,00 x 2,00	15	65,00 x 5,00	15
30,00 x 2,00	15	70,00 x 5,00	15
32,00 x 2,00	15	75,00 x 5,00	15
34,00 x 2,00	15	80,00 x 5,00	5
36,00 x 2,00	15	85,00 x 5,00	5
38,00 x 2,00	15	90,00 x 5,00	5
40,00 x 2,00	15	95,00 x 5,00	5
42,00 x 2,00	15	100,00 x 5,00	5
44,00 x 2,00	15	105,00 x 5,00	5
46,00 x 2,00	15	110,00 x 5,00	5
48,00 x 2,00	15	115,00 x 5,00	5
50,00 x 2,00	15	120,00 x 5,00	5

Box D consists of 24 sizes - 285 off

**Design:** O-ring  
**Construction type:** metric standard  
**Colour:** Box, red  
**Temp. min.:** -30 °C  
**Temp. max.:** 100 °C  
**FPM temp. min.:** -15 °C  
**FPM temp. max.:** 200 °C

Identification	Material	Blower
BOX D NBR90	NBR 90 Shore A	24
BOX D FPM80	FPM 80 Shore A	24
BOX D	NBR 70 Shore A	24

Web: <http://cat.hansa-flex.com/en/BOXD>

## BOX G

### Boxed set G, norm AS/BS, small



D x d	Range/Quantity	D x d	Range/Quantity
2,98 x 1,78	28	20,22 x 3,53	30
3,68 x 1,78	28	21,62 x 3,53	30
4,48 x 1,78	28	23,48 x 3,53	30
5,28 x 1,78	28	24,98 x 3,53	30
6,07 x 1,78	28	26,58 x 3,53	30
7,06 x 1,78	28	28,17 x 3,53	30
8,25 x 1,78	28	29,78 x 3,53	30
9,18 x 2,62	12	31,34 x 3,53	30
10,78 x 2,62	12	32,92 x 3,53	30
12,37 x 2,62	12	34,52 x 3,53	30
13,85 x 2,62	12	36,19 x 3,53	30
15,54 x 2,62	12	37,89 x 3,53	30
17,13 x 2,62	12	39,47 x 5,34	7
18,72 x 2,62	12	40,85 x 5,34	7
19,64 x 3,53	12	43,82 x 5,34	7

Box G consists of 30 sizes - 382 off

**Design:** O-ring  
**Construction type:** Standard AS / BS  
**Colour:** Box, red  
**Temp. min.:** -30 °C  
**Temp. max.:** 100 °C

Identification	Material	Blower
BOX G	NBR 70 Shore A	30
BOX G NBR90	NBR 90 Shore A	30

Web: <http://cat.hansa-flex.com/en/BOXG>

## BOX H

### Boxed set H, small metric



D x d	Range/Quantity	D x d	Range/Quantity
3,00 x 2,00	18	20,00 x 3,00	12
4,00 x 2,00	18	22,00 x 3,00	12
5,00 x 2,00	18	24,00 x 3,00	12
6,00 x 2,00	18	25,00 x 3,00	12
7,00 x 2,00	12	27,00 x 3,00	12
8,00 x 2,00	12	28,00 x 3,00	12
10,00 x 2,00	12	30,00 x 3,00	12
10,00 x 2,50	14	32,00 x 3,00	12
11,00 x 2,50	14	33,00 x 3,00	12
12,00 x 2,50	14	35,00 x 3,00	12
14,00 x 2,50	14	36,00 x 3,00	12
16,00 x 2,50	14	38,00 x 3,00	12
17,00 x 2,50	14	40,00 x 4,00	5
18,00 x 2,50	12	42,00 x 4,00	5
19,00 x 3,00	12	45,00 x 4,00	5

Box H consists of 30 sizes - 404 off

**Design:** O-ring  
**Construction type:** metric standard  
**Colour:** Box, yellow  
**Temp. min.:** -30 °C  
**Temp. max.:** 100 °C

Identification	Material	Blower
BOX H	NBR 70 Shore A	30
BOX H NBR90	NBR 90 Shore A	30

Web: <http://cat.hansa-flex.com/en/BOXH>

**BOX Schnur**

Boxed set cord & tools

**Design:** O-ring cord  
**Included in scope of supply:** Blade, cutting device, adhesive, measuring tape  
**Colour:** Box, red  
**Temp. min.:** -30 °C  
**Temp. max.:** 100 °C  
**Material:** NBR 70 Shore

d (mm)	NBR	FFM
1,76	2 m	1 m
2,00	2 m	1 m
2,40	2 m	1 m
2,62	2 m	1 m
3,00	2 m	1 m
3,53	2 m	1 m
4,00	2 m	1 m
4,50	2 m	1 m
5,00	2 m	1 m
5,54	2 m	1 m
5,70	2 m	1 m
6,00	2 m	1 m
7,00	2 m	1 m
8,00	2 m	1 m



**Identification**

BOX CORD NBR

**Web:** <http://cat.hansa-flex.com/en/BOXSCHNUR>

**SF SET CAT**

O-ring set, CAT

**Design:** Sealing ring  
**Construction type:** for SFS-CAT  
**Material:** NBR

Bezeichnung	Menge/ Quantity	Ø d1	Ø d2	S
SFDR1P3700	10	19,5	25,0	5
SFDR1P3702	10	25,4	32,2	5
SFDR1P3703	10	31,9	38,7	5
SFDR1P3704	10	38,2	45,0	5
SFDR1P3705	10	44,7	51,5	5
SFDR1P3706	10	51,1	57,9	5
SFDR1P3707	10	54,2	61,0	5
SFDR1P3708	5	57,4	64,2	5
SFDR1P3709	5	63,9	70,7	5

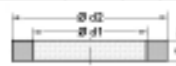

**Identification**

SF SET CAT

**Dimension**

330mm x 220mm x 60mm

**Web:** <http://cat.hansa-flex.com/en/SFSETCAT>

**QR (70° Shore NBR)**

**Quad ring 70SH NBR**



Spaltmaß / Clearance	
a	e max.
1,78	0,05
2,62 - 3,53	0,07
5,34 - 6,99	0,10

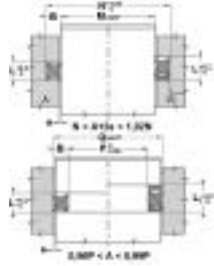

Low spatial requirement and low friction. Numerous applications possible in static and dynamic sectors, no distortion possible with rotational movements.

- Design:** Quad ring
- Operating pressure:** up to 150 bar, up to 400 bar with support ring
- Sliding speed max.:** 0,5 m/s
- Temp. min.:** -30 °C
- Temp. max.:** 110 °C
- Media:** Mineral oils, HFA, HFB
- Installation:** in external and internal grooves
- Material:** NBR 70 Shore A

**Note:** Rotational movements (consult us) up to 2 m/s QR6, QR7, QR8 must be fitted into an open groove type B Clearance: a= 1.78; e max.=0.05 a= 2.62 - 3.53; e max.=0.07 a= 5.34 - 6.99; e max.=0.1

**Ordering information:** For special operating conditions (fluid, temperature, pressure ...) please contact us. Alternative material possible: NBR 90, EPDM, MVQ, FPM

Identification	a	Ø A	Identification	a	Ø A
	mm	mm		mm	mm
QR 6	1,78	2,90	QR 341	5,34	88,27
QR 7	1,78	3,68	QR 342	5,34	91,44
QR 8	1,78	4,47	QR 343	5,34	94,62
QR 9	1,78	5,28	QR 344	5,34	97,79
QR 10	1,78	6,07	QR 345	5,34	100,14
QR 11	1,78	7,65	QR 346	5,34	104,14
QR 12	1,78	9,25	QR 347	5,34	107,32
QR 110	2,62	9,19	QR 348	5,34	110,50
QR 111	2,62	10,77	QR 349	5,34	113,67
QR 112	2,62	12,37	QR 356	5,34	135,89
QR 113	2,62	13,94	QR 425	6,99	113,67
QR 114	2,62	15,54	QR 426	6,99	116,84
QR 115	2,62	17,12	QR 427	6,99	120,02
QR 116	2,62	18,72	QR 428	6,99	123,20
QR 117	2,62	20,29	QR 429	6,99	126,37
QR 124	2,62	31,42	QR 430	6,99	129,54
QR 210	3,53	18,64	QR 431	6,99	132,72
QR 211	3,53	20,22	QR 432	6,99	135,90
QR 212	3,53	21,82	QR 433	6,99	139,06
QR 213	3,53	23,40	QR 434	6,99	142,24
QR 214	3,53	24,99	QR 435	6,99	145,42
QR 215	3,53	26,58	QR 436	6,99	148,60
QR 216	3,53	28,17	QR 437	6,99	151,77
QR 217	3,53	29,75	QR 438	6,99	158,12
QR 218	3,53	31,34	QR 439	6,99	194,47
QR 219	3,53	32,92	QR 440	6,99	170,82
QR 220	3,53	34,52	QR 441	6,99	177,17
QR 221	3,53	36,09	QR 442	6,99	183,52
QR 222	3,53	37,69	QR 443	6,99	189,97
QR 223	3,53	40,87	QR 444	6,99	196,22
QR 224	3,53	44,05	QR 445	6,99	202,57
QR 325	5,34	37,47	QR 446	6,99	215,27
QR 326	5,34	40,65	QR 447	6,99	227,97
QR 327	5,34	43,82	QR 448	6,99	240,67
QR 328	5,34	47,00	QR 449	6,99	253,30
QR 329	5,34	50,16	QR 450	6,99	266,07
QR 330	5,34	53,34	QR 451	6,99	278,77
QR 331	5,34	56,52	QR 452	6,99	291,47
QR 332	5,34	59,69	QR 453	6,99	304,17
QR 333	5,34	62,87	QR 454	6,99	316,87
QR 334	5,34	66,04	QR 455	6,99	329,57
QR 335	5,34	69,22	QR 456	6,99	342,30
QR 336	5,34	72,39	QR 457	6,99	355,00
QR 337	5,34	75,57	QR 458	6,99	367,67
QR 338	5,34	78,74	QR 459	6,99	380,37
QR 339	5,34	81,92	QR 460	6,99	393,07
QR 340	5,34	85,09			

**Web:** <http://cat.hansa-flex.com/en/QR70SHORENBR>

Support ring BU

Simple solution. The rings do not need to be cut. Economical solution.

- Design:** Support ring
- Operating pressure:** up to 500 bar
- Colour:** black
- Temp. min.:** -30 °C
- Temp. max.:** 110 °C
- Media:** Mineral oils
- Installation:** in closed installation spaces
- Material:** NBR 90 Shore A

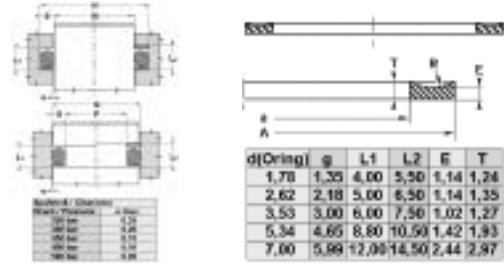

**Note:** Clearance: Pressure = 250 bar / e max.= 0.25 Pressure = 300 bar / e max.= 0.20 Pressure = 350 bar / e max.= 0.15 Pressure = 400 bar / e max.= 0.10 Pressure = 500 bar / e max.= 0.05

Identification	Ø d mm	Ø D mm	OR	Identification	Ø d mm	Ø D mm	OR
BU 4	2,44	5,14	1.78 x 1.78	BU 130	41,73	46,09	40.94 x 2.62
BU 5	3,23	5,93	2.57 x 1.78	BU 131	43,33	47,69	42.52 x 2.62
BU 6	3,56	6,26	2.90 x 1.78	BU 132	44,91	49,27	44.12 x 2.62
BU 7	4,34	7,04	3.68 x 1.78	BU 133	46,51	50,87	45.69 x 2.62
BU 8	5,13	7,83	4.47 x 1.78	BU 134	48,08	52,44	47.29 x 2.62
BU 9	5,94	8,64	5.28 x 1.78	BU 135	49,68	54,04	48.90 x 2.62
BU 10	6,73	9,43	6.07 x 1.78	BU 136	51,26	55,62	50.47 x 2.62
BU 11	8,31	11,01	7.65 x 1.78	BU 137	52,86	57,22	52.07 x 2.62
BU 12	9,91	12,61	9.25 x 1.78	BU 138	54,43	58,79	53.64 x 2.62
BU 13	11,56	14,26	10.82 x 1.78	BU 139	56,03	60,39	55.25 x 2.62
BU 14	13,16	15,86	12.42 x 1.78	BU 140	57,61	61,97	56.82 x 2.62
BU 15	14,73	17,43	14.00 x 1.78	BU 141	59,21	63,57	58.42 x 2.62
BU 16	16,33	19,03	15.60 x 1.78	BU 142	60,78	65,14	59.99 x 2.62
BU 17	17,91	20,61	17.17 x 1.78	BU 143	62,38	66,74	61.60 x 2.62
BU 18	19,51	22,21	18.77 x 1.78	BU 144	63,96	68,32	63.17 x 2.62
BU 19	21,08	23,78	20.35 x 1.78	BU 145	65,56	69,92	64.77 x 2.62
BU 20	22,68	25,38	21.95 x 1.78	BU 146	67,13	71,49	66.34 x 2.62
BU 21	24,26	26,96	23.52 x 1.78	BU 147	68,73	73,09	67.95 x 2.62
BU 22	25,86	28,56	25.12 x 1.78	BU 148	70,31	74,67	69.52 x 2.62
BU 23	27,43	30,13	26.70 x 1.78	BU 149	71,91	76,27	71.12 x 2.62
BU 24	29,03	31,73	28.30 x 1.78	BU 150	73,48	77,84	72.69 x 2.62
BU 25	30,61	33,31	29.87 x 1.78	BU 151	76,66	81,02	75.87 x 2.62
BU 26	32,21	34,91	31.47 x 1.78	BU 152	83,01	87,37	82.22 x 2.62
BU 27	33,78	36,48	33.05 x 1.78	BU 153	89,36	93,72	88.57 x 2.62
BU 28	35,38	38,08	34.65 x 1.78	BU 154	95,71	100,07	94.92 x 2.62
BU 29	38,56	41,26	37.82 x 1.78	BU 155	102,06	106,42	101.27 x 2.62
BU 30	41,73	44,43	41.00 x 1.78	BU 156	108,41	112,77	107.62 x 2.62
BU 31	44,91	47,61	44.17 x 1.78	BU 157	144,76	119,12	113.97 x 2.62
BU 32	48,08	50,78	47.35 x 1.78	BU 158	121,11	125,47	120.32 x 2.62
BU 33	51,26	53,96	50.52 x 1.78	BU 159	127,46	131,82	126.67 x 2.62
BU 34	54,43	57,13	53.70 x 1.78	BU 160	133,81	138,17	133.02 x 2.62
BU 35	57,61	60,31	56.87 x 1.78	BU 161	140,16	144,52	139.37 x 2.62
BU 36	60,78	63,48	60.05 x 1.78	BU 162	146,51	150,87	145.72 x 2.62
BU 37	63,96	66,66	63.22 x 1.78	BU 163	152,86	157,22	152.07 x 2.62
BU 38	67,13	69,83	66.40 x 1.78	BU 164	159,21	163,57	158.42 x 2.62
BU 39	70,31	73,01	69.57 x 1.78	BU 165	165,56	170,01	164.77 x 2.62
BU 40	73,48	76,18	72.75 x 1.78	BU 166	171,91	176,27	171.12 x 2.62
BU 41	76,66	79,36	75.92 x 1.78	BU 167	178,26	182,62	177.47 x 2.62
BU 42	83,01	85,71	82.27 x 1.78	BU 168	184,61	188,97	183.82 x 2.62
BU 43	89,36	92,06	88.62 x 1.78	BU 169	190,96	195,32	190.17 x 2.62
BU 44	95,71	98,41	94.97 x 1.78	BU 170	197,31	201,67	196.52 x 2.62
BU 45	102,06	104,76	101.32 x 1.78	BU 171	203,66	208,02	202.87 x 2.62
BU 46	108,41	111,11	107.67 x 1.78	BU 172	210,01	214,37	209.22 x 2.62
BU 47	114,76	117,46	114.02 x 1.78	BU 173	216,36	220,72	215.57 x 2.62
BU 48	121,11	123,81	120.37 x 1.78	BU 174	222,71	227,07	221.92 x 2.62
BU 49	127,46	130,16	126.72 x 1.78	BU 175	229,06	233,42	228.27 x 2.62
BU 50	133,81	136,51	133.07 x 1.78	BU 176	235,41	239,77	234.62 x 2.62
BU 103	2,77	7,13	2.06 x 2.62	BU 177	241,76	246,12	240.97 x 2.62
BU 104	3,56	7,92	2.84 x 2.62	BU 178	248,11	252,47	247.32 x 2.62
BU 105	4,34	8,70	3.63 x 2.62	BU 201	5,13	11,13	4.34 x 3.53
BU 106	5,13	9,49	4.42 x 2.62	BU 202	6,73	12,73	5.94 x 3.53
BU 107	5,93	10,29	5.23 x 2.62	BU 203	8,30	14,30	7.52 x 3.53
BU 108	6,73	11,09	6.02 x 2.62	BU 204	9,90	15,90	9.12 x 3.53
BU 109	8,31	12,67	7.59 x 2.62	BU 205	11,56	17,56	10.69 x 3.53
BU 110	9,91	14,27	9.19 x 2.62	BU 206	13,16	19,16	12.29 x 3.53
BU 111	11,48	15,84	10.77 x 2.62	BU 207	14,73	20,73	13.87 x 3.53
BU 112	13,08	17,44	12.37 x 2.62	BU 208	16,33	22,33	15.47 x 3.53
BU 113	14,66	19,02	13.94 x 2.62	BU 209	17,90	23,90	17.04 x 3.53
BU 114	16,26	20,62	15.54 x 2.62	BU 210	19,46	25,46	18.64 x 3.53
BU 115	17,83	22,19	17.12 x 2.62	BU 211	21,03	27,03	20.22 x 3.53
BU 116	19,43	23,79	18.72 x 2.62	BU 212	22,63	28,63	21.82 x 3.53
BU 117	21,11	25,47	20.30 x 2.62	BU 213	24,21	30,21	23.39 x 3.53
BU 118	22,68	27,04	21.89 x 2.62	BU 214	25,81	31,81	24.99 x 3.53
BU 119	24,28	28,64	23.47 x 2.62	BU 215	27,38	33,38	26.57 x 3.53
BU 120	25,86	30,22	25.07 x 2.62	BU 216	28,98	34,98	28.17 x 3.53
BU 121	27,46	31,82	26.64 x 2.62	BU 217	30,56	36,56	29.74 x 3.53
BU 122	29,03	33,39	28.24 x 2.62	BU 218	32,16	38,16	31.34 x 3.53
BU 123	30,63	34,99	29.82 x 2.62	BU 219	33,88	39,88	32.92 x 3.53
BU 124	32,21	36,57	31.42 x 2.62	BU 220	35,48	41,48	34.52 x 3.53
BU 125	33,81	38,17	32.99 x 2.62	BU 221	37,06	43,06	36.09 x 3.53
BU 126	35,38	39,74	34.59 x 2.62	BU 222	38,66	44,66	37.69 x 3.53
BU 127	36,98	41,34	36.17 x 2.62	BU 223	41,83	47,83	40.87 x 3.53
BU 128	38,56	42,92	37.77 x 2.62	BU 224	45,01	51,01	44.04 x 3.53
BU 129	40,16	44,52	39.34 x 2.62	BU 225	48,18	54,18	47.22 x 3.53

Support ring BU

Identification	Ø d mm	Ø D mm	OR	Identification	Ø d mm	Ø D mm	OR
BU 226	51,36	57,36	50.39 x 3.53	BU 339	83,13	92,43	81.92 x 5.34
BU 227	54,53	60,53	53.57 x 3.53	BU 340	86,31	95,61	85.09 x 5.34
BU 228	57,71	63,71	56.74 x 3.53	BU 341	89,48	98,78	88.27 x 5.34
BU 229	60,88	66,88	59.92 x 3.53	BU 342	92,66	101,96	91.44 x 5.34
BU 230	64,06	70,06	63.09 x 3.53	BU 343	95,83	105,13	94.62 x 5.34
BU 231	66,83	72,83	66.27 x 3.53	BU 344	99,01	108,31	97.79 x 5.34
BU 232	70,00	76,00	69.44 x 3.53	BU 345	102,31	111,61	100.97 x 5.34
BU 233	73,18	79,18	72.62 x 3.53	BU 346	105,49	114,79	104.14 x 5.34
BU 234	76,35	82,35	75.79 x 3.53	BU 347	108,66	117,96	107.32 x 5.34
BU 235	79,53	85,53	78.97 x 3.53	BU 348	111,84	121,14	110.49 x 5.34
BU 236	82,70	88,70	82.14 x 3.53	BU 349	115,01	124,31	113.67 x 5.34
BU 237	85,88	91,88	85.32 x 3.53	BU 350	118,19	127,49	116.84 x 5.34
BU 238	89,05	95,05	88.49 x 3.53	BU 351	121,36	130,66	120.02 x 5.34
BU 239	92,23	98,23	91.67 x 3.53	BU 352	124,54	133,84	123.19 x 5.34
BU 240	95,40	101,40	94.84 x 3.53	BU 353	127,71	137,01	126.37 x 5.34
BU 241	98,58	104,58	98.02 x 3.53	BU 354	130,89	140,19	129.54 x 5.34
BU 242	101,75	107,75	101.19 x 3.53	BU 355	134,06	143,36	132.72 x 5.34
BU 243	104,93	110,93	104.37 x 3.53	BU 356	137,24	146,54	135.89 x 5.34
BU 244	108,10	114,10	107.54 x 3.53	BU 357	140,41	149,71	139.07 x 5.34
BU 245	111,28	117,28	110.72 x 3.53	BU 358	143,59	152,89	142.24 x 5.34
BU 246	114,45	120,45	113.89 x 3.53	BU 359	146,76	156,06	145.42 x 5.34
BU 247	117,63	123,63	117.07 x 3.53	BU 360	149,94	159,24	148.59 x 5.34
BU 248	121,11	127,11	120.24 x 3.53	BU 361	153,11	162,41	151.77 x 5.34
BU 249	124,28	130,28	123.42 x 3.53	BU 362	156,28	165,58	154.94 x 5.34
BU 250	127,46	133,46	126.59 x 3.53	BU 363	159,45	168,75	158.12 x 5.34
BU 251	130,63	136,63	129.77 x 3.53	BU 364	162,62	171,92	161.29 x 5.34
BU 252	133,81	139,81	132.94 x 3.53	BU 365	165,79	175,09	164.47 x 5.34
BU 253	136,98	142,98	136.12 x 3.53	BU 366	168,96	178,26	167.64 x 5.34
BU 254	140,16	146,16	139.29 x 3.53	BU 367	172,13	181,43	170.82 x 5.34
BU 255	143,33	149,33	142.47 x 3.53	BU 368	175,30	184,60	174.00 x 5.34
BU 256	146,51	152,51	145.64 x 3.53	BU 369	178,47	187,77	177.17 x 5.34
BU 257	149,68	155,68	148.82 x 3.53	BU 370	181,64	190,94	180.34 x 5.34
BU 258	152,86	158,86	151.99 x 3.53	BU 371	184,81	194,11	183.52 x 5.34
BU 259	156,03	162,03	155.17 x 3.53	BU 372	187,98	197,28	186.69 x 5.34
BU 260	159,21	165,21	158.34 x 3.53	BU 373	191,15	200,45	189.87 x 5.34
BU 261	162,38	168,38	161.52 x 3.53	BU 374	194,32	203,62	193.04 x 5.34
BU 262	165,56	171,56	164.69 x 3.53	BU 375	197,49	206,79	196.22 x 5.34
BU 263	168,73	174,73	167.87 x 3.53	BU 376	200,66	209,96	199.39 x 5.34
BU 264	171,91	177,91	171.04 x 3.53	BU 377	203,83	213,13	202.57 x 5.34
BU 265	175,08	181,08	174.22 x 3.53	BU 378	207,00	216,30	205.74 x 5.34
BU 266	178,26	184,26	177.39 x 3.53	BU 379	210,17	219,47	208.92 x 5.34
BU 267	181,43	187,43	180.57 x 3.53	BU 380	213,34	222,64	212.10 x 5.34
BU 268	184,61	190,61	183.74 x 3.53	BU 381	216,51	225,81	215.27 x 5.34
BU 269	187,78	193,78	186.92 x 3.53	BU 382	219,68	228,98	218.45 x 5.34
BU 270	190,96	196,96	190.09 x 3.53	BU 383	222,85	232,15	221.62 x 5.34
BU 271	194,13	200,13	193.27 x 3.53	BU 384	226,02	235,32	224.80 x 5.34
BU 272	197,31	203,31	196.44 x 3.53	BU 385	229,19	238,49	227.97 x 5.34
BU 273	200,48	206,48	199.62 x 3.53	BU 386	232,36	241,66	231.15 x 5.34
BU 274	203,66	209,66	202.79 x 3.53	BU 387	235,53	244,83	234.32 x 5.34
BU 275	206,83	212,83	205.97 x 3.53	BU 388	238,70	248,00	237.50 x 5.34
BU 276	210,01	216,01	209.14 x 3.53	BU 389	241,87	251,17	240.67 x 5.34
BU 277	213,18	219,18	212.32 x 3.53	BU 390	245,04	254,34	243.85 x 5.34
BU 278	216,36	222,36	215.49 x 3.53	BU 391	248,21	257,51	247.02 x 5.34
BU 279	219,53	225,53	218.67 x 3.53	BU 392	251,38	260,68	250.20 x 5.34
BU 280	222,71	228,71	221.84 x 3.53	BU 393	254,55	263,85	253.37 x 5.34
BU 281	225,88	231,88	225.02 x 3.53	BU 394	257,72	267,02	256.55 x 5.34
BU 282	229,06	235,06	228.19 x 3.53	BU 395	260,89	270,19	259.72 x 5.34
BU 283	232,23	238,23	231.37 x 3.53	BU 396	264,06	273,36	262.90 x 5.34
BU 284	235,41	241,41	234.54 x 3.53	BU 397	267,23	276,53	266.07 x 5.34
BU 285	238,58	244,58	237.72 x 3.53	BU 398	270,40	279,70	269.25 x 5.34
BU 286	241,76	247,76	240.89 x 3.53	BU 399	273,57	282,87	272.42 x 5.34
BU 287	244,93	250,93	244.07 x 3.53	BU 400	276,74	286,04	275.60 x 5.34
BU 288	248,11	254,11	247.24 x 3.53	BU 401	279,91	289,21	278.77 x 5.34
BU 289	251,28	257,28	250.42 x 3.53	BU 402	283,08	292,38	281.95 x 5.34
BU 290	254,46	260,46	253.59 x 3.53	BU 403	286,25	295,55	285.12 x 5.34
BU 291	257,63	263,63	256.77 x 3.53	BU 404	289,42	298,72	288.30 x 5.34
BU 292	260,81	266,81	259.94 x 3.53	BU 405	292,59	301,89	291.47 x 5.34
BU 293	263,98	269,98	263.12 x 3.53	BU 406	295,76	305,06	294.65 x 5.34
BU 294	267,16	273,16	266.29 x 3.53	BU 407	298,93	308,23	297.82 x 5.34
BU 295	270,33	276,33	269.47 x 3.53	BU 408	302,10	311,40	301.00 x 5.34
BU 296	273,51	279,51	272.64 x 3.53	BU 409	305,27	314,57	304.17 x 5.34
BU 297	276,68	282,68	275.82 x 3.53	BU 410	308,44	317,74	307.35 x 5.34
BU 298	279,86	285,86	278.99 x 3.53	BU 411	311,61	320,91	310.52 x 5.34
BU 299	283,03	289,03	282.17 x 3.53	BU 412	314,78	324,08	313.70 x 5.34
BU 300	286,21	292,21	285.34 x 3.53	BU 413	317,95	327,25	316.87 x 5.34
BU 301	289,38	295,38	288.52 x 3.53	BU 414	321,12	330,42	320.05 x 5.34
BU 302	292,56	298,56	291.69 x 3.53	BU 415	324,29	333,59	323.22 x 5.34
BU 303	295,73	301,73	294.87 x 3.53	BU 416	327,46	336,76	326.40 x 5.34
BU 304	298,91	304,91	298.04 x 3.53	BU 417	330,63	339,93	329.57 x 5.34
BU 305	302,08	308,08	301.22 x 3.53	BU 418	333,80	343,10	332.75 x 5.34
BU 306	305,26	311,26	304.39 x 3.53	BU 419	336,97	346,27	335.92 x 5.34
BU 307	308,43	314,43	307.57 x 3.53	BU 420	340,14	349,44	339.10 x 5.34
BU 308	311,61	317,61	310.74 x 3.53	BU 421	343,31	352,61	342.27 x 5.34
BU 309	314,78	320,78	313.92 x 3.53	BU 422	346,48	355,78	345.45 x 5.34
BU 310	317,96	323,96	317.09 x 3.53	BU 423	349,65	358,95	348.62 x 5.34
BU 311	321,13	327,13	320.27 x 3.53	BU 424	352,82	362,12	351.80 x 5.34
BU 312	324,31	330,31	323.44 x 3.53	BU 425	355,99	365,29	354.97 x 5.34
BU 313	327,48	333,48	326.62 x 3.53	BU 426	359,16	368,46	358.15 x 5.34
BU 314	330,66	336,66	329.79 x 3.53	BU 427	362,33	371,63	361.32 x 5.34
BU 315	333,83	339,83	332.97 x 3.53	BU 428	365,50	374,80	364.50 x 5.34
BU 316	337,01	343,01	336.14 x 3.53	BU 429	368,67	377,97	367.67 x 5.34
BU 317	340,18	346,18	339.32 x 3.53	BU 430	371,84	381,14	370.85 x 5.34
BU 318	343,36	349,36	342.49 x 3.53	BU 431	375,01	384,31	374.02 x 5.34
BU 319	346,53	352,53	345.67 x 3.53	BU 432	378,18	387,48	377.20 x 5.34
BU 320	349,71	355,71	348.84 x 3.53	BU 433	381,35	390,65	380.37 x 5.34
BU 321	352,88	358,88	352.02 x 3.53	BU 434	384,52	393,82	383.55 x 5.34
BU 322	356,06	362,06	355.19 x 3.53	BU 435	387,69	396,99	386.72 x 5.34
BU 323	359,23	365,23	358.37 x 3.53	BU 436	390,86	400,16	389.90 x 5.34
BU 324	362,41	368,41	361.54 x 3.53	BU 437	394,03	403,33	393.07 x 5.34
BU 325	365,58	371,58	364.72 x 3.53	BU 438	397,20	406,50	396.25 x 5.34
BU 326	368,76	374,76	367.89 x 3.53	BU 439	400,37	409,67	399.42 x 5.34
BU 327	371,93	377,93	371.07 x 3.53	BU 440	403,54	412,84	402.60 x 5.34
BU 328	375,11	381,11	374.24 x 3.53	BU 441	406,71	416,01	405.77 x 5.34
BU 329	378,28	384,28	377.42 x 3.53	BU 442	409,88	419,18	408.95 x 5.34
BU 330	381,46	387,46	380.59 x 3.53	BU 443	413,05	422,35	412.12 x 5.34
BU 331	384,63	390,63	383.77 x 3.53	BU 444	416,22	425,52	415.30 x 5.34
BU 332	387,81	393,81	386.94 x 3.53	BU 445	419,39	428,69	418.47 x 5.34
BU 333	390,98	396,98	390.12 x 3.53	BU 446	422,56	431,86	421.65 x 5.34
BU 334	394,16	400,16	393.29 x 3.53	BU 447	425,73	435,03	424.82 x 5.34
BU 335	397,33	403,33	396.47 x 3.53	BU 448	428,90	438,20	428.00 x 5.34
BU 336	400,51	406,51	399.64 x 3.53	BU 449	432,07	441,37	431.17 x 5.34
BU 337	403,68	409,68	402.82 x 3.53	BU 450	435,24	444,54	434.35 x 5.34
BU 338	406,86	412,86	405.99 x 3.53	BU 451	438,41	447,71	437.52 x 5.34
BU 339	410,03	416,03	409.17 x 3.53	BU 452	441,58	450,88	440.70 x 5.34
BU 340	413,21	419,21	412.34 x 3.53	BU 453	444,75	454,05	443.87 x 5.34
BU 341	416,38	422,38	415.52 x 3.53	BU 454	447,92	457,22	447.05 x 5.34
BU 342	419,56	425,56	418.69 x 3.53	BU 455	451,09	460,39	450.22 x 5.34
BU 343	422,73	428,73	421.87 x 3.53	BU 456	454,26	463,56	453.40 x 5.34
BU 3							

Spiral support ring BR

**Design:** Support ring  
**Operating pressure:** up to 500 bar  
**Colour:** white  
**Temp. min.:** -200 °C  
**Temp. max.:** 260 °C  
**Media:** Mineral oils, HFA, HFB, HFC, HFD, steam  
**Material:** PTFE

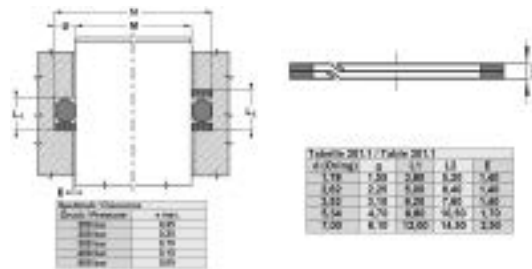

Identification	M	N	OR
	mm	mm	
BR 6	3,0	6,1	2.90 x 1.78
BR 7	4,0	7,1	3.68 x 1.78
BR 8	4,5	7,6	4.47 x 1.78
BR 9	5,0	8,1	5.28 x 1.78
BR 10	7,0	10,1	6.07 x 1.78
BR 610	7,0	10,1	6.75 x 1.78
BR 11	8,0	11,1	7.65 x 1.78
BR 611	9,0	12,1	8.73 x 1.78
BR 12	9,0	12,1	9.25 x 1.78
BR 13	11,0	14,1	10.82 x 1.78
BR 14	13,0	16,1	12.42 x 1.78
BR 15	14,0	17,1	14.00 x 1.78
BR 16	16,0	19,1	15.60 x 1.78
BR 17	17,0	20,1	17.17 x 1.78
BR 18	19,0	22,1	18.77 x 1.78
BR 19	21,0	24,1	20.35 x 1.78
BR 20	22,0	25,1	23.52 x 1.78
BR 21	24,0	27,1	23.52 x 1.78
BR 22	25,0	28,1	25.12 x 1.78
BR 24	28,0	31,1	28.30 x 1.78
BR 25	30,0	33,1	29.87 x 1.78
BR 28	35,0	38,1	34.65 x 1.78
BR 110	10,0	14,5	9.19 x 2.62
BR 613	10,0	14,5	9.90 x 2.62
BR 111	11,0	15,5	10.77 x 2.62
BR 614	12,0	16,5	11.91 x 2.62
BR 615	13,0	17,5	13.10 x 2.62
BR 113	14,0	18,5	13.94 x 2.62
BR 616	15,0	19,5	15.08 x 2.62
BR 114	16,0	20,5	15.54 x 2.62
BR 809	16,0	20,5	15.88 x 2.62
BR 115	17,0	21,5	17.12 x 2.62
BR 116	19,0	23,5	18.72 x 2.62
BR 117	20,0	24,5	20.30 x 2.62
BR 812	21,0	25,5	20.64 x 2.62
BR 118	22,0	26,5	21.89 x 2.62
BR 119	24,0	28,5	23.47 x 2.62
BR 120	25,0	29,5	25.07 x 2.62
BR 121	27,0	31,5	26.64 x 2.62
BR 122	28,0	32,5	28.24 x 2.62
BR 123	30,0	34,5	29.82 x 2.62
BR 124	32,0	36,5	31.42 x 2.62
BR 125	33,0	37,5	32.99 x 2.62
BR 126	35,0	39,5	34.59 x 2.62
BR 127	36,0	40,5	36.17 x 2.62
BR 128	38,0	42,5	37.77 x 2.62
BR 129	40,0	44,5	39.34 x 2.62
BR 130	41,0	45,5	40.94 x 2.62
BR 131	43,0	47,5	42.52 x 2.62
BR 133	46,0	50,5	45.69 x 2.62
BR 134	48,0	52,5	47.29 x 2.62
BR 135	49,0	53,5	48.90 x 2.62
BR 136	51,0	55,5	50.47 x 2.62
BR 137	52,0	56,5	52.07 x 2.62
BR 139	55,0	59,5	55.25 x 2.62
BR 140	57,0	61,5	56.82 x 2.62
BR 141	59,0	63,5	58.42 x 2.62
BR 142	60,0	64,5	59.99 x 2.62
BR 143	62,0	66,5	61.60 x 2.62
BR 144	63,0	67,5	63.17 x 2.62
BR 148	70,0	74,5	69.52 x 2.62
BR 151	76,0	80,5	75.87 x 2.62
BR 152	82,0	86,5	82.22 x 2.62
BR 153	89,0	93,5	88.57 x 2.62
BR 154	95,0	99,5	94.92 x 2.62
BR 156	108,0	112,5	107.62 x 2.62
BR 157	114,0	118,5	113.97 x 2.62
BR 210	19,0	25,2	18.64 x 3.53
BR 211	20,0	26,2	20.22 x 3.53
BR 212	22,0	28,2	21.82 x 3.53
BR 213	23,0	29,2	23.39 x 3.53
BR 214	25,0	31,2	24.99 x 3.53
BR 215	27,0	33,2	26.57 x 3.53
BR 216	28,0	34,2	28.17 x 3.53
BR 217	30,0	36,2	29.74 x 3.53
BR 218	31,0	37,2	31.34 x 3.53
BR 219	33,0	39,2	32.92 x 3.53

Identification	M	N	OR
	mm	mm	
BR 220	35,0	41,2	34.52 x 3.53
BR 221	36,0	42,2	36.09 x 3.53
BR 222	38,0	44,2	37.69 x 3.53
BR 824	40,0	46,2	39.70 x 3.53
BR 223	42,0	48,2	40.87 x 3.53
BR 825	42,0	48,2	41.28 x 3.53
BR 826	43,0	49,2	42.86 x 3.53
BR 224	45,0	51,2	44.04 x 3.53
BR 828	46,0	52,2	46.04 x 3.53
BR 829	48,0	54,2	47.62 x 3.53
BR 830	49,0	55,2	49.20 x 3.53
BR 226	51,0	57,2	50.39 x 3.53
BR 832	52,0	58,2	52.40 x 3.53
BR 227	54,0	60,2	53.57 x 3.53
BR 834	56,0	62,2	55.56 x 3.53
BR 228	57,0	63,2	56.74 x 3.53
BR 836	59,0	65,2	58.74 x 3.53
BR 229	60,0	66,2	59.92 x 3.53
BR 838	62,0	68,2	61.90 x 3.53
BR 230	64,0	70,2	63.09 x 3.53
BR 231	67,0	73,2	66.27 x 3.53
BR 842	68,0	74,2	68.26 x 3.53
BR 843	70,0	76,2	69.44 x 3.53
BR 844	72,0	78,2	71.44 x 3.53
BR 233	73,0	79,2	72.62 x 3.53
BR 846	75,0	81,2	74.60 x 3.53
BR 234	76,0	82,2	75.79 x 3.53
BR 235	79,0	85,2	78.97 x 3.53
BR 236	82,0	88,2	82.14 x 3.53
BR 237	85,0	91,2	85.32 x 3.53
BR 238	89,0	95,2	88.49 x 3.53
BR 239	92,0	98,2	91.67 x 3.53
BR 240	95,0	101,2	94.84 x 3.53
BR 241	98,0	104,2	98.02 x 3.53
BR 242	101,0	107,2	101.19 x 3.53
BR 243	105,0	111,2	104.37 x 3.53
BR 244	108,0	114,2	107.54 x 3.53
BR 245	110,0	117,2	110.72 x 3.53
BR 246	114,0	120,2	113.89 x 3.53
BR 247	117,0	123,2	117.07 x 3.53
BR 248	120,0	126,2	120.24 x 3.53
BR 249	123,0	129,2	123.42 x 3.53
BR 250	127,0	133,2	126.59 x 3.53
BR 252	133,0	139,2	132.94 x 3.53
BR 254	140,0	146,2	139.29 x 3.53
BR 255	143,0	149,2	142.47 x 3.53
BR 256	146,0	152,2	145.64 x 3.53
BR 257	149,0	155,2	148.82 x 3.53
BR 258	152,0	158,2	151.99 x 3.53
BR 260	165,0	171,2	164.69 x 3.53
BR 262	178,0	184,2	177.39 x 3.53
BR 263	184,0	190,2	183.74 x 3.53
BR 264	190,0	196,2	190.09 x 3.53
BR 265	197,0	203,2	196.44 x 3.53
BR 266	203,0	209,2	202.57 x 3.53
BR 272	241,0	247,2	240.89 x 3.53
BR 276	280,0	286,2	278.99 x 3.53
BR 326	41,0	50,4	40.64 x 5.34
BR 327	44,0	53,4	43.82 x 5.34
BR 328	47,0	56,4	46.99 x 5.34
BR 329	50,0	59,4	50.17 x 5.34
BR 330	53,0	62,4	53.34 x 5.34
BR 331	57,0	66,4	56.52 x 5.34
BR 332	60,0	69,4	59.69 x 5.34
BR 333	63,0	72,4	62.87 x 5.34
BR 334	66,0	75,4	66.04 x 5.34
BR 335	69,0	78,4	69.22 x 5.34
BR 336	73,0	82,4	72.39 x 5.34
BR 619	75,0	84,4	74.63 x 5.34
BR 337	76,0	85,4	75.57 x 5.34
BR 338	79,0	88,4	78.74 x 5.34
BR 620	80,0	89,4	79.73 x 5.34
BR 339	82,0	91,4	81.92 x 5.34
BR 340	85,0	94,4	85.09 x 5.34
BR 341	88,0	97,4	88.27 x 5.34
BR 621	90,0	99,4	89.69 x 5.34
BR 342	92,0	101,4	91.44 x 5.34

BR

(Continued)

## Spiral support ring BR

Identification	M mm	N mm	OR	Identification	M mm	N mm	OR
BR 343	95,0	104,4	94.62 x 5.34	BR 430	130,0	142,2	129.54 x 7.00
BR 344	98,0	107,4	97.79 x 5.34	BR 431	133,0	145,2	132.72 x 7.00
BR 622	100,0	109,4	100.00 x 5.34	BR 432	136,0	148,2	135.89 x 7.00
BR 345	101,0	110,4	100.97 x 5.34	BR 433	139,0	151,2	139.07 x 7.00
BR 346	104,0	113,4	104.14 x 5.34	BR 434	142,0	154,2	142.24 x 7.00
BR 623	110,0	119,4	109.54 x 5.34	BR 435	145,0	157,2	145.42 x 7.00
BR 348	110,0	119,4	110.49 x 5.34	BR 436	149,0	161,2	148.59 x 7.00
BR 349	114,0	123,4	113.67 x 5.34	BR 437	152,0	164,2	151.77 x 7.00
BR 350	117,0	126,4	116.84 x 5.34	BR 872	156,0	158,2	155.60 x 7.00
BR 860	118,0	127,4	117.48 x 5.34	BR 438	158,0	170,2	158.12 x 7.00
BR 351	121,0	130,4	120.02 x 5.34	BR 874	162,0	174,2	161.90 x 7.00
BR 352	124,0	133,4	123.19 x 5.34	BR 439	165,0	177,2	164.47 x 7.00
BR 354	130,0	139,4	129.54 x 5.34	BR 628	167,0	179,2	166.70 x 7.00
BR 355	133,0	142,4	132.72 x 5.34	BR 876	168,0	180,2	168.30 x 7.00
BR 865	133,0	143,4	133.35 x 5.34	BR 440	170,0	182,2	170.82 x 7.00
BR 356	137,0	146,4	135.89 x 5.34	BR 878	175,0	187,2	174.60 x 7.00
BR 357	140,0	149,4	139.07 x 5.34	BR 442	184,0	196,2	183.52 x 7.00
BR 867	140,0	149,4	139.70 x 5.34	BR 882	188,0	200,2	187.30 x 7.00
BR 358	143,0	152,4	142.24 x 5.34	BR 443	190,0	202,2	189.87 x 7.00
BR 359	146,0	155,4	145.42 x 5.34	BR 884	194,0	206,2	193.70 x 7.00
BR 360	150,0	159,4	148.59 x 5.34	BR 444	196,0	208,2	196.22 x 7.00
BR 361	152,0	161,4	151.77 x 5.34	BR 445	203,0	215,2	202.57 x 7.00
BR 362	158,0	167,4	158.12 x 5.34	BR 674	210,0	222,2	208.92 x 7.00
BR 363	165,0	174,4	164.47 x 5.34	BR 446	215,0	227,2	215.27 x 7.00
BR 364	171,0	180,4	170.82 x 5.34	BR 676	222,0	234,2	221.62 x 7.00
BR 365	178,0	187,4	177.17 x 5.34	BR 447	230,0	242,2	227.97 x 7.00
BR 366	184,0	193,4	183.52 x 5.34	BR 678	235,0	247,2	234.32 x 7.00
BR 367	190,0	199,4	189.87 x 5.34	BR 448	240,0	252,2	240.67 x 7.00
BR 368	196,0	205,4	196.22 x 5.34	BR 680	248,0	260,2	247.00 x 7.00
BR 370	209,0	218,4	208.92 x 5.34	BR 449	255,0	267,2	253.37 x 7.00
BR 371	215,0	224,4	215.27 x 5.34	BR 682	260,0	272,2	259.70 x 7.00
BR 373	228,0	237,4	227.97 x 5.34	BR 450	265,0	277,2	266.07 x 7.00
BR 374	234,0	243,4	234.32 x 5.34	BR 684	273,0	285,2	272.40 x 7.00
BR 375	241,0	250,4	240.67 x 5.34	BR 451	280,0	292,2	278.77 x 7.00
BR 376	247,0	256,4	247.02 x 5.34	BR 686	285,0	297,2	285.10 x 7.00
BR 377	253,0	262,4	253.37 x 5.34	BR 452	292,0	304,2	291.47 x 7.00
BR 379	280,0	289,4	278.77 x 5.34	BR 688	300,0	312,2	297.80 x 7.00
BR 380	292,0	301,4	278.99 x 3.53	BR 453	305,0	317,2	304.17 x 7.00
BR 425	114,0	126,2	113.67 x 7.00	BR 454	318,0	330,2	316.87 x 7.00
BR 624	115,0	127,2	114.70 x 7.00	BR 455	330,0	342,2	329.57 x 7.00
BR 426	117,0	129,2	116.84 x 7.00	BR 458	370,0	382,2	367.67 x 7.00
BR 427	120,0	132,2	120.02 x 7.00	BR 459	380,0	392,2	380.37 x 7.00
BR 428	123,0	135,2	123.20 x 7.00	BR 460	393,0	405,2	393.07 x 7.00
BR 429	126,0	138,2	126.37 x 7.00				

Web: <http://cat.hansa-flex.com/en/BR>



**Support ring MBK**

Easy assembly. The rings do not need to be cut. Economical solution.

- Design:** Support ring
- Operating pressure:** up to 500 bar
- Temp. min.:** -50 °C
- Temp. max.:** 130 °C
- Media:** Mineral oils, HFA, HFB
- Installation:** in closed installation spaces
- Material:** PBTB (polyester 55 Shore D)

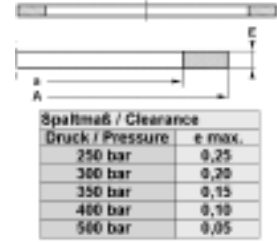
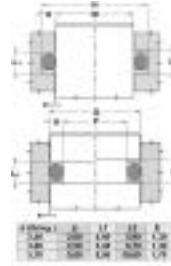

**Note:** Clearance: Pressure = 250 bar / e max.= 0.25 Pressure = 300 bar / e max.= 0.20 Pressure = 350 bar / e max.= 0.15 Pressure = 400 bar / e max.= 0.10 Pressure = 500 bar / e max.= 0.05

Identification	M	N	e	OR	Identification	M	N	e	OR
	mm	mm	mm			mm	mm	mm	
MBK 4 8	4,0	8,0	1,3	3.30 x 2.40	MBK 85 90	85,0	90,0	1,3	84.50 x 3.00
MBK 6 10	6,0	10,0	1,3	5.30 x 2.40	MBK 85 95	85,0	95,0	1,7	84.20 x 5.70
MBK 7 11	7,0	11,0	1,3	6.30 x 2.40	MBK 90 95	90,0	95,0	1,3	89.50 x 3.00
MBK 10 14	10,0	14,0	1,3	9.30 x 2.30	MBK 90 100	90,0	100,0	1,7	89.20 x 5.70
MBK 11 15	11,0	15,0	1,3	10.30 x 2.40	MBK 92 99	92,5	99,1	1,4	92.00 x 4.00
MBK 12 16	12,0	16,0	1,3	11.30 x 2.30	MBK 94 99	94,0	99,0	1,3	93.00 x 3.00
MBK 13 17	13,0	17,0	1,3	12.30 x 2.40	MBK 95 100	95,0	100,0	1,3	94.50 x 3.00
MBK 14 18	14,0	18,0	1,3	13.30 x 2.40	MBK 95 105	95,0	105,0	1,7	94.20 x 5.70
MBK 15 19	15,0	19,0	1,3	14.30 x 2.40	MBK 100 105	100,0	105,0	1,3	99.50 x 3.00
MBK 16 20	16,0	20,0	1,3	15.30 x 2.40	MBK 100 110	100,0	110,0	1,7	99.20 x 5.70
MBK 17 21	17,0	21,0	1,3	16.30 x 2.40	MBK 105 110	105,0	110,0	1,3	104.50 x 3.00
MBK 18 22	18,0	22,0	1,3	17.30 x 2.40	MBK 105 115	105,0	115,0	1,7	104.20 x 5.70
MBK 20 25	20,0	25,0	1,3	19.20 x 3.00	MBK 110 115	110,0	115,0	1,3	109.50 x 3.00
MBK 23 28	23,0	28,0	1,3	22.20 x 3.00	MBK 110 120	110,0	120,0	1,7	109.20 x 5.70
MBK 25 30	25,0	30,0	1,3	24.20 x 3.00	MBK 113 118	113,0	118,0	1,3	112.00 x 3.00
MBK 27 32	27,0	32,0	1,3	26.20 x 3.00	MBK 115 120	115,0	120,0	1,3	114.50 x 3.00
MBK 30 35	30,0	35,0	1,3	29.20 x 3.00	MBK 115 125	115,0	125,0	1,7	114.20 x 5.70
MBK 35 40	35,0	40,0	1,3	34.20 x 3.00	MBK 120 125	120,0	125,0	1,3	119.50 x 3.00
MBK 37 42	37,0	42,0	1,3	36.20 x 3.00	MBK 120 130	120,0	130,0	1,7	119.20 x 5.70
MBK 40 45	40,0	45,0	1,3	39.20 x 3.00	MBK 125 130	125,0	130,0	1,3	124.50 x 3.00
MBK 40 50	40,0	50,0	1,7	39.20 x 5.70	MBK 125 135	125,0	135,0	1,7	124.20 x 5.70
MBK 45 50	45,0	50,0	1,3	44.20 x 3.00	MBK 130 135	130,0	135,0	1,3	129.50 x 3.00
MBK 45 55	45,0	55,0	1,7	44.20 x 5.70	MBK 130 140	130,0	140,0	1,7	129.20 x 5.70
MBK 50 55	50,0	55,0	1,3	49.50 x 3.00	MBK 135 140	135,0	140,0	1,3	134.50 x 3.00
MBK 50 60	50,0	60,0	1,7	49.20 x 5.70	MBK 135 145	135,0	145,0	1,7	134.20 x 5.70
MBK 53 63	53,0	63,0	1,7	52.20 x 5.70	MBK 140 145	140,0	145,0	1,3	139.50 x 3.00
MBK 55 65	55,0	65,0	1,7	54.20 x 5.70	MBK 140 150	140,0	150,0	1,7	139.20 x 5.70
MBK 55 60	55,0	60,0	1,3	54.50 x 3.00	MBK 142 151	142,0	151,0	1,8	
MBK 58 63	58,0	63,0	1,3	57.20 x 3.00	MBK 145 150	145,0	150,0	1,3	144.50 x 3.00
MBK 60 65	60,0	65,0	1,3	59.50 x 3.00	MBK 145 155	145,0	155,0	1,7	144.20 x 5.70
MBK 60 67	60,0	67,0	1,5	39.20 x 5.70	MBK 150 160	150,0	160,0	1,7	149.20 x 5.70
MBK 60 70	60,0	70,0	1,7	59.20 x 5.70	MBK 152 161	152,0	161,0	1,8	
MBK 63 68	63,0	68,0	1,3	62.20 x 3.00	MBK 155 165	155,0	165,0	1,7	154.20 x 5.70
MBK 65 70	65,0	70,0	1,3	64.50 x 3.00	MBK 160 170	160,0	170,0	1,7	159.20 x 5.70
MBK 65 75	65,0	75,0	1,7	64.20 x 5.70	MBK 165 175	165,0	175,0	1,7	164.20 x 5.70
MBK 69 74	69,0	74,0	1,3	69.00 x 3.00	MBK 170 180	170,0	180,0	1,7	169.20 x 5.70
MBK 70 75	70,0	75,0	1,3	69.50 x 3.00	MBK 175 185	175,0	185,0	1,7	174.20 x 5.70
MBK 70 77	70,0	77,0	1,5	39.20 x 5.70	MBK 180 190	180,0	190,0	1,7	179.20 x 5.70
MBK 70 80	70,0	80,0	1,7	69.20 x 5.70	MBK 185 195	185,0	195,0	1,7	184.20 x 5.70
MBK 72 77	72,5	77,5	1,3	72.00 x 3.00	MBK 190 200	190,0	200,0	1,7	189.20 x 5.70
MBK 72 82	72,5	82,5	1,7	71.20 x 5.70	MBK 195 205	195,0	205,0	1,7	194.20 x 5.70
MBK 75 80	75,0	80,0	1,3	74.50 x 3.00	MBK 200 210	200,0	210,0	1,7	199.20 x 5.70
MBK 75 85	75,0	85,0	1,7	74.20 x 5.70	MBK 210 220	210,0	220,0	1,7	209.20 x 5.70
MBK 78 88	78,0	88,0	1,7	87.20 x 5.70	MBK 220 230	220,0	230,0	1,7	219.20 x 5.70
MBK 79 84	79,0	84,0	1,3	78.00 x 3.00	MBK 230 240	230,0	240,0	1,7	229.20 x 5.70
MBK 80 85	80,0	85,0	1,3	79.50 x 3.00	MBK 240 250	240,0	250,0	1,7	239.20 x 5.70
MBK 80 87	80,0	87,0	1,5	39.20 x 5.70	MBK 250 260	250,0	260,0	1,7	249.20 x 5.70
MBK 80 90	80,0	90,0	1,7	79.20 x 5.70	MBK 270 280	270,0	280,0	1,7	269.20 x 5.70

**Web:** <http://cat.hansa-flex.com/en/MBK>

**PBK**

**Support ring PBK**



Spaltmaß / Clearance	
Druck / Pressure	e max.
250 bar	0,25
300 bar	0,20
350 bar	0,15
400 bar	0,10
500 bar	0,05

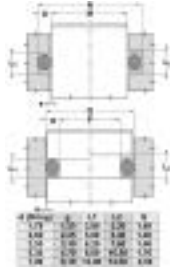

Easy assembly. The rings do not need to be cut. Economical solution.

- Operating pressure:** up to 500 bar
- Temp. min.:** -50 °C
- Temp. max.:** 130 °C
- Media:** Mineral oils, HFA, HFB
- Installation:** in closed installation spaces
- Material:** PBTB (polyester 55 Shore D)

**Note:** Clearance: Pressure = 250 bar / e max.= 0.25 Pressure = 300 bar / e max.= 0.20 Pressure = 350 bar / e max.= 0.15 Pressure = 400 bar / e max.= 0.10 Pressure = 500 bar / e max.= 0.05

Identification	M	N	P	Q	OR
	mm	mm	mm	mm	
PBK 010-610	7,0	10,1	6,9	10	6.07 x 1.78
PBK 11	8,0	11,1	7,9	11	7.65 x 1.78
PBK 611	9,0	12,1	8,9	12	8.73 x 1.78
PBK 12	9,0	12,1	9,9	13	9.25 x 1.78
PBK 109	9,0	13,5	9,5	14	7.60 x 2.62
PBK 110-613	10,0	14,5	10,5	15	9.19 x 2.62
PBK 13	11,0	14,1	10,9	14	10.82 x 1.78
PBK 111	11,0	15,5	11,5	16	10.77 x 2.62
PBK 614	12,0	16,5	12,5	17	11.91 x 2.62
PBK 112	12,5	17,0	13,5	18	12.37 x 2.62
PBK 14	13,0	16,1	12,9	16	12.42 x 1.78
PBK 15	14,0	17,1	14,9	18	14.00 x 1.78
PBK 113	14,0	18,5	14,5	19	13.94 x 2.62
PBK 616	15,0	19,5	15,5	20	15.08 x 2.62
PBK 16	16,0	19,1	15,9	19	15.60 x 1.78
PBK 114-809	16,0	20,5	16,5	21	15.54 x 2.62
PBK 17	17,0	20,1	17,9	21	17.17 x 1.78
PBK 115	17,0	21,5	17,5	22	17.12 x 2.62
PBK 617	18,0	22,5	18,5	23	17.86 x 2.62
PBK 116	19,0	23,5	19,5	24	18.72 x 2.62
PBK 210	19,0	25,2	19,8	26	18.64 x 3.53
PBK 117	20,0	24,5	20,5	25	20.30 x 2.62
PBK 211	20,0	26,2	21,8	28	20.22 x 3.53
PBK 19	21,0	24,1	20,9	24	20.35 x 1.78
PBK 812	21,0	25,5	21,5	26	20.64 x 2.62
PBK 20	22,0	25,1	22,9	26	21.95 x 1.78
PBK 118-813	22,0	26,5	22,5	27	21.89 x 2.62
PBK 212	22,0	28,2	22,8	29	21.82 x 3.53
PBK 213	23,0	29,2	23,8	30	23.39 x 3.53
PBK 119-814	24,0	28,5	24,5	29	23.47 x 2.62
PBK 120	25,0	29,5	25,5	30	25.07 x 2.62
PBK 214	25,0	31,2	25,8	32	24.99 x 3.53
PBK 618	26,0	32,2	26,8	33	26.80 x 3.53
PBK 121	27,0	31,5	27,5	32	26.64 x 2.62
PBK 215	27,0	33,2	27,8	34	26.57 x 3.53
PBK 24	28,0	31,1	28,9	32	28.30 x 1.78
PBK 122	28,0	32,5	28,5	33	28.24 x 2.62
PBK 216	28,0	34,2	28,8	35	28.17 x 3.53
PBK 123	30,0	34,5	30,5	35	29.82 x 2.62
PBK 217	30,0	36,2	30,8	37	29.74 x 3.53
PBK 218	31,0	37,2	31,8	38	31.34 x 3.53
PBK 26	32,0	35,1	31,9	35	31.47 x 1.78
PBK 124	32,0	36,5	32,5	37	31.42 x 2.62
PBK 125	33,0	37,5	33,5	38	32.99 x 2.62
PBK 219	33,0	39,2	33,8	40	32.92 x 3.53
PBK 126	35,0	39,5	35,5	40	34.59 x 2.62
PBK 220	35,0	41,2	35,8	42	34.52 x 3.53
PBK 127	36,0	40,5	36,5	41	36.17 x 2.62
PBK 221	36,0	42,2	36,8	43	36.09 x 3.53
PBK 29	38,0	41,1	37,9	41	37.82 x 1.78
PBK 128	38,0	42,5	38,5	43	37.77 x 2.62
PBK 222	38,0	44,2	38,8	45	37.69 x 3.53
PBK 325	38,0	47,4	38,6	48	37.47 x 5.34
PBK 129	40,0	44,5	40,5	45	39.34 x 2.62
PBK 824	40,0	46,2	39,8	46	39.70 x 3.53
PBK 30	41,0	44,1	41,9	45	41.00 x 1.78
PBK 130	41,0	45,5	41,5	46	40.94 x 2.62
PBK 326	41,0	50,4	42,6	52	40.64 x 5.34
PBK 223-825	42,0	48,2	41,8	48	40.87 x 3.53
PBK 131	43,0	47,5	43,5	48	42.52 x 2.62
PBK 826	43,0	49,2	43,8	50	42.86 x 3.53
PBK 132	44,0	48,5	44,5	49	44.12 x 2.62
PBK 327	44,0	53,4	45,6	55	43.82 x 5.34
PBK 224-827	45,0	51,2	44,8	51	44.04 x 3.53
PBK 133	46,0	50,5	46,5	51	45.69 x 2.62
PBK 828	46,0	52,2	46,8	53	46.04 x 3.53
PBK 328	47,0	56,4	48,6	58	46.99 x 5.34
PBK 32	48,0	51,1	47,9	51	47.35 x 1.78
PBK 134	48,0	52,5	48,5	53	47.29 x 2.62
PBK 225-829	48,0	54,2	47,8	54	47.22 x 3.53
PBK 135	49,0	53,5	48,5	54	48.90 x 2.62
PBK 830	49,0	55,2	49,8	56	49.20 x 3.53
PBK 329	50,0	59,4	51,6	61	50.17 x 5.34
PBK 136	51,0	55,5	51,5	56	50.47 x 2.62



(Continued)

PBK

## Support ring PBK

Identification	M mm	N mm	P mm	Q mm	OR
PBK 226-831	51,0	57,2	51,8	58	50.39 x 3.53
PBK 137	52,0	56,5	52,5	57	52.07 x 2.62
PBK 832	52,0	58,2	53,8	60	52.40 x 3.53
PBK 330	53,0	62,4	54,6	64	53.34 x 5.34
PBK 138	54,0	58,5	54,5	59	53.64 x 2.62
PBK 227-833	54,0	60,2	54,8	61	53.57 x 3.53
PBK 139	55,0	59,5	56,5	61	55.25 x 2.62
PBK 834	56,0	62,2	55,8	62	55.56 x 3.53
PBK 140	57,0	61,5	57,5	62	56.82 x 2.62
PBK 228-835	57,0	63,2	57,8	64	56.74 x 3.53
PBK 331	57,0	66,4	58,6	68	56.52 x 5.34
PBK 141	59,0	63,5	59,5	64	58.42 x 2.62
PBK 836	59,0	65,2	58,8	65	58.74 x 3.53
PBK 142	60,0	64,5	60,5	65	59.99 x 2.62
PBK 229-837	60,0	66,2	60,8	67	59.92 x 3.53
PBK 332	60,0	69,4	60,6	70	59.69 x 5.34
PBK 143	62,0	66,5	62,5	67	61.60 x 2.62
PBK 838	62,0	68,2	62,8	69	61.90 x 3.53
PBK 144	63,0	67,5	63,5	68	63.17 x 2.62
PBK 333	63,0	72,4	63,6	73	62.87 x 5.34
PBK 230-839	64,0	70,2	63,8	70	63.09 x 3.53
PBK 145	65,0	69,5	65,5	70	64.77 x 2.62
PBK 840	65,0	71,2	65,8	72	65.10 x 3.53
PBK 334	66,0	75,4	67,6	77	66.04 x 5.34
PBK 146	67,0	71,5	67,5	72	66.34 x 2.62
PBK 231-841	67,0	73,2	66,8	73	66.27 x 3.53
PBK 147	68,0	72,5	68,5	73	67.95 x 2.62
PBK 842	68,0	74,2	68,8	75	68.26 x 3.53
PBK 335	69,0	78,4	70,6	80	69.22 x 5.34
PBK 148	70,0	74,5	70,5	75	69.52 x 2.62
PBK 232-843	70,0	76,2	70,8	77	69.44 x 3.53
PBK 149	71,0	75,5	71,5	76	71.12 x 2.62
PBK 844	72,0	78,2	71,8	78	71.44 x 3.53
PBK 150	73,0	77,5	73,5	78	72.69 x 2.62
PBK 233-845	73,0	79,2	73,8	80	72.62 x 3.53
PBK 336	73,0	82,4	73,6	83	72.39 x 5.34
PBK 846	75,0	81,2	74,8	81	74.60 x 3.53
PBK 619	75,0	84,4	75,6	85	74.63 x 5.34
PBK 234	76,0	82,2	76,8	83	75.79 x 3.53
PBK 337	76,0	85,4	76,6	86	75.57 x 5.34
PBK 235	79,0	85,2	79,8	86	78.97 x 3.53
PBK 338-620	79,0	88,4	80,6	90	78.74 x 5.34
PBK 152	82,0	86,5	83,5	88	82.22 x 2.62
PBK 236	82,0	88,2	82,8	89	82.14 x 3.53
PBK 339	82,0	91,4	82,6	92	81.92 x 5.34
PBK 237	85,0	91,2	85,8	92	85.32 x 3.53
PBK 340	85,0	94,4	85,6	95	85.09 x 5.34
PBK 341	88,0	97,4	88,6	98	88.27 x 5.34
PBK 153	89,0	93,5	89,5	94	88.57 x 2.62
PBK 238	89,0	95,2	88,8	95	88.49 x 3.53
PBK 621	90,0	99,4	90,6	100	89.69 x 5.34
PBK 239	92,0	98,2	92,8	99	91.67 x 3.53
PBK 342	92,0	101,4	92,6	102	91.44 x 5.34
PBK 154	95,0	99,5	96,5	101	94.92 x 2.62
PBK 240	95,0	101,2	95,8	102	94.84 x 3.53
PBK 343	95,0	104,4	65,6	105	94.62 x 5.34
PBK 241	98,0	104,2	98,8	105	98.02 x 3.53
PBK 344	98,0	107,4	98,6	108	97.79 x 5.34
PBK 622	100,0	109,4	100,6	110	100.00 x 5.34
PBK 242	101,0	107,2	101,8	108	101.19 x 3.53
PBK 345	101,0	110,4	101,6	111	100.97 x 5.34
PBK 346	104,0	113,4	105,6	115	104.14 x 5.34
PBK 243	105,0	111,2	104,8	111	104.37 x 3.53
PBK 347	107,0	116,5	108,6	118	107.32 x 5.34
PBK 244	108,0	114,2	107,8	114	107.54 x 3.53
PBK 348-623	110,0	119,4	111,6	121	110.49 x 5.34
PBK 245	111,0	117,2	111,8	118	110.72 x 3.53
PBK 157	114,0	118,5	115,5	120	113.97 x 2.62
PBK 246	114,0	120,2	114,8	121	113.89 x 3.53
PBK 349	114,0	123,4	115,6	125	113.67 x 5.34
PBK 425	114,0	126,2	114,8	127	113.67 x 7.00
PBK 247	117,0	123,2	117,8	124	117.07 x 3.53
PBK 350-860	117,0	126,4	118,6	128	116.84 x 5.34
PBK 426	117,0	129,2	117,8	130	116.84 x 7.00
PBK 248	120,0	126,2	120,8	127	120.24 x 3.53
PBK 351-861	121,0	130,4	122,6	132	120.02 x 5.34
PBK 249	123,0	129,2	123,8	130	123.42 x 3.53
PBK 428	123,0	135,2	124,8	137	123.20 x 7.00
PBK 862	124,0	133,4	125,6	135	123.80 x 5.34
PBK 429	126,0	138,2	127,8	140	126.37 x 7.00
PBK 250	127,0	133,2	126,8	133	126.59 x 3.53
PBK 353-863	127,0	136,4	127,6	137	126.37 x 5.34
PBK 251	130,0	136,2	129,8	136	129.77 x 3.53
PBK 354-864	130,0	139,4	130,6	140	129.54 x 5.34
PBK 252	133,0	139,2	133,8	140	132.94 x 3.53
PBK 431	133,0	145,2	133,8	146	132.72 x 7.00
PBK 865	134,0	143,4	135,6	145	133.35 x 5.34
PBK 253	136,0	142,2	136,8	143	136.12 x 3.53
PBK 432-433	136,0	148,2	140,8	153	135.89 x 7.00
PBK 356-866	137,0	146,4	137,6	147	135.89 x 5.34
PBK 254	140,0	146,2	139,8	146	139.29 x 3.53
PBK 357-867	140,0	149,4	140,6	150	139.07 x 5.34

## PBK

(Continued)

## Support ring PBK

Identification	M mm	N mm	P mm	Q mm	OR
PBK 255	143,0	149,2	142,8	149	142.47 x 3.53
PBK 358-868	143,0	152,4	143,6	153	142.24 x 5.34
PBK 435	145,0	157,2	147,8	160	145.42 x 7.00
PBK 257	149,0	155,2	148,8	155	148.82 x 3.53
PBK 360-870	150,0	159,4	150,6	160	148.59 x 5.34
PBK 258	152,0	158,2	152,8	159	151.99 x 3.53
PBK 872	156,0	168,2	157,8	170	155.60 x 7.00
PBK 362	158,0	167,4	159,6	169	158.12 x 5.34
PBK 363	165,0	174,4	165,6	175	164.47 x 5.34
PBK 628	167,0	179,2	167,8	180	166.70 x 7.00
PBK 364	171,0	180,4	172,6	182	170.82 x 5.34
PBK 365	178,0	187,4	178,6	188	177.17 x 5.34
PBK 880	180,0	192,2	182,8	195	181.00 x 7.00
PBK 263	184,0	190,2	183,8	190	183.74 x 3.53
PBK 442	184,0	196,2	184,8	197	183.52 x 7.00
PBK 367	190,0	199,4	190,6	200	189.87 x 5.34
PBK 443	190,0	202,2	190,8	203	189.87 x 7.00
PBK 884	194,0	206,2	194,8	207	193.70 x 7.00
PBK 368	196,0	205,4	197,6	207	196.22 x 5.34
PBK 444	196,0	208,2	197,8	210	196.22 x 7.00
PBK 266	203,0	209,2	203,8	210	202.57 x 3.53
PBK 370	209,0	218,4	210,6	220	208.92 x 5.34
PBK 446	215,0	227,2	217,8	230	215.27 x 7.00
PBK 269	222,0	228,2	221,8	228	221.84 x 3.53
PBK 372	222,0	231,4	222,6	232	221.62 x 5.34
PBK 373	228,0	237,4	229,6	239	227.97 x 5.34
PBK 447	230,0	242,2	229,8	242	227.97 x 7.00
PBK 678	235,0	247,2	237,8	250	234.32 x 7.00
PBK 684	273,0	285,2	273,8	286	272.40 x 7.00

Web: <http://cat.hansa-flex.com/en/PBK>

UR / 08BS

Usit ring, UR

Perfect tightness. Prevents loosening of the parts.

- Design:** Usit ring
- Construction type:** with internally vulcanised, trapezoidal elastic rubber sealing bead
- Temp. min.:** -30 °C
- Temp. max.:** 110 °C
- Material:** 1) NBR 90 Shore A, (2) Cadmium-plated or passivated carbon steel
- Surface:** Metal ring: zinc chromated

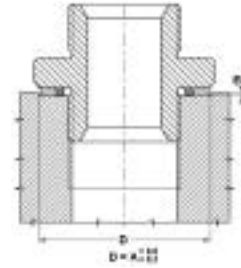

Toleranz / Tolerance				
Größe / Range	A	B	C	E
5, 2, 3	+0,13	+/-0,13	+/-0,13	+/-0,15
5	0	+0,20	0	+/-0,15
	-0,20	B	B	

Identification	for thread	for thread	for thread	A	B	C	E	Pressure PB
				mm	mm	mm	mm	bar
UR 5.7-9-1	-		M 5	9,00	6,80	5,70	1,00	1400
UR 6.2-9.2-1	-		M 5.5	9,20	7,20	6,20	1,00	1220
08BS 304	-		M 6	11,00	8,00	6,60	1,00	1680
08BS 206	-		M 6	10,00	8,00	6,70	1,00	1130
UR 6.7-11-1	-		M 6	11,00	8,20	6,70	1,00	1510
UR 6.9-13.2-1.3	-	1/4 inch	-	13,21	8,00	6,86	1,30	2450
UR 7-13.4-1.3	-	1/4 inch	-	13,34	9,53	6,99	1,30	1700
08BS 306	-		M 6	11,40	8,40	7,00	1,00	1540
08BS 006	-	5/16 inch	-	13,34	9,53	8,31	1,30	1700
UR 8.5-13.4-1	-		M 8	13,00	9,40	8,50	1,00	1780
08BS 007	-	5/16 inch	-	14,22	10,04	8,64	1,30	1750
UR 8.7-13-1	-		M 8	13,00	10,00	8,70	1,00	1330
UR 8.7-14-1	-		M 8	14,00	10,40	8,70	1,00	1550
UR 8.7-14.2-1.3	-	5/16 inch	-	14,20	10,04	8,70	1,30	1750
UR 9.3-13.3-1	-		-	13,00	10,50	9,30	1,00	1200
UR 10.35-16-2	-		M 10	16,00	12,00	10,35	2,00	1470
08BS 020	G 1/8"	3/8 inch	-	15,88	11,84	10,37	2,00	1500
08BS 510	G 1/8"		-	14,70	12,00	10,40	1,25	930
UR 10.7-16-1.5	-		M 10	16,00	12,40	10,70	1,50	1350
08BS 310	-		M 10	17,00	12,10	10,70	1,50	1730
UR 10.7-18-1.5	-		M 10	18,00	12,40	10,70	1,50	1880
08BS 008	-	7/16 inch	-	18,36	12,45	11,26	2,00	1950
UR 11.4-16.3-1.5	-		M 11	16,30	12,70	11,40	1,50	1280
08BS 009	-	7/16 inch	-	19,05	13,08	11,69	2,00	1900
UR 11.8-18.5-1.5	-		M 11	18,50	13,70	11,80	1,50	1540
UR 11.8-19.1-1.5	-		M 11	19,10	13,50	11,80	1,50	1770
UR 12.7-18-1.5	-		M 12	18,00	14,40	12,70	1,50	1250
08BS 313	-		M 12	19,00	14,10	12,70	1,50	1530
UR 12.7-20-1.5	-		M 12	20,00	14,00	12,70	1,50	1680
UR 13.7-20-1.5	-		M 13	20,00	15,40	13,70	1,50	1340
UR 13.7-22-1.5	-		M 13	22,00	15,40	13,70	1,50	1810
08BS 021	G 1/4"	1/2 inch	-	20,57	15,21	13,74	2,00	1550
08BS 315	-		-	20,10	15,20	13,80	1,50	1440
08BS 511	G 1/4"		-	18,70	15,75	13,90	1,25	793
UR 14-18.7-1.5	-		-	18,70	15,70	14,00	1,50	900
08BS 316	-		M 14	21,00	16,10	14,70	1,50	1370
UR 14.7-22-1.5	-		M 14	22,00	16,40	14,70	1,50	1510
08BS 022	-	19/32 inch	-	22,23	17,30	15,83	2,00	1310
UR 16-22.7-1.5	-		M 15	22,00	17,78	16,00	1,50	1260
08BS 011	-	5/8 inch	-	25,40	18,75	16,51	2,00	1550
08BS 317	-		M 16	23,00	18,10	16,70	1,50	1240
UR 16.7-24-1.5	-		M 16	24,00	18,40	16,70	1,50	1400
08BS 023	G 3/8"		-	23,80	18,75	17,28	2,00	1260
08BS 512	G 3/8"		-	22,70	19,25	17,30	1,25	775
UR 17.4-24-1.5	-		M 17	24,00	19,20	17,40	1,50	1150
UR 18-24.7-1.5	-		-	24,70	20,10	18,00	1,50	1070
UR 18.2-25.4-2.5	-	11/16 inch	-	25,40	16,69	18,16	2,50	1320
UR 18.7-26-1.5	-		M 18	26,00	20,40	18,70	1,50	1275
08BS 320	-		M 18	27,00	20,40	18,70	2,00	1450
08BS 024	-	3/4 inch	-	26,92	21,21	19,69	2,50	1260
UR 20.7-28-1.5	-		M 20	28,00	22,50	20,70	1,50	1150
08BS 321	-		M 20	29,00	22,40	20,70	2,00	1340
UR 21.5-28.7-2.5	-		M 21	28,70	23,30	21,50	2,50	1080
08BS 025	G 1/2"	13/16 inch	-	28,58	23,01	21,54	2,50	1150
08BS 513	G 1/2"		-	26,70	23,55	21,70	1,25	586
08BS 323	-		-	30,00	23,40	21,70	2,00	1290
UR 22.5-28-1.5	-		M 22	28,00	24,20	22,50	1,50	760
UR 22.7-30-2	-		M 22	30,00	24,40	22,70	2,00	1100
08BS 324	-		M 22	31,00	24,40	22,70	2,00	1240
08BS 026	-		-	31,75	24,97	23,49	2,50	1250
08BS 013	-	15/16 inch	-	33,27	26,40	24,26	2,50	1275
UR 24.7-32-2	-		M 24	32,00	26,40	24,70	2,00	1050
08BS 326	-		M 24	33,00	26,40	24,70	2,00	1160
UR 26.7-35-2	-		-	35,00	28,40	26,70	2,00	1050
UR 27-35-2.5	G 3/4"	1 inch	-	34,93	28,53	27,05	2,50	1060
08BS 514	-	5/8 inch	-	32,50	29,20	27,30	1,25	500
08BS 328	-		M 27	36,00	29,40	27,70	2,00	1060
08BS 028	-	1 1/16 inch	-	38,61	30,61	27,82	2,50	1250
08BS 329	-		-	36,00	30,30	28,60	2,00	730
08BS 014	-	1 1/8 inch	-	36,58	30,86	29,33	2,50	900
08BS 331	-		M 30	39,00	32,40	30,70	2,00	970
08BS 029	G 7/8"	1 3/16 inch	-	38,10	32,29	30,81	2,50	900
UR 31-39-2	-		M 30	39,00	32,40	31,00	2,00	970
08BS 015	-	1 1/4 inch	-	41,40	35,69	32,64	3,40	810
UR 33.7-42-2	-		M 33	42,00	35,40	33,70	2,00	900
UR 33.9-42.9-3.4	G 1"	1 5/16 inch	-	42,80	36,88	33,89	3,40	790
08BS 515	-	1 inch	-	39,50	36,10	34,20	2,00	414

UR / 08BS

(Continued)

Usit ring, UR

Identification	for thread	for thread	for thread	A	B	C	E	Pressure PB
				mm	mm	mm	mm	bar
UR 34.3-43-2	-		M 33	43,00	36,40	34,30	2,00	880
08BS 016	-	1 3/8 inch	-	44,45	38,99	35,94	3,40	700
UR 36.7-46-2	-		M 36	46,00	38,80	36,70	2,00	890
08BS 333	-		-	48,00	39,60	37,00	2,50	1010
08BS 017	-	1 1/2 inch	-	47,75	42,04	38,96	3,40	700
UR 40-51-2.5	-		M 39	51,00	42,60	40,00	2,50	970
UR 42.7-53-3	-		M 42	53,00	44,00	42,70	3,00	800
08BS 516	G 1.1/4"		-	49,50	44,70	42,80	2,00	500
08BS 032	G 1.1/4"	1 5/8 inch	-	52,38	45,93	42,93	3,40	690
08BS 018	-	1 3/4 inch	-	57,15	48,39	45,34	3,40	875
08BS 033	G 1.1/2"	1 7/8 inch	-	58,60	51,39	48,44	3,40	690
08BS 517	-	1 1/2 inch	M 48	55,50	50,60	48,70	2,00	434
UR 48.7-59-3	-		M 48	59,00	50,80	48,70	3,00	800
08BS 337	-		M 48	60,00	51,60	49,00	2,50	790
UR 53.3-64.5-3	-		M 52	64,50	56,40	53,30	3,00	710
08BS 034	G 1 3/4"	2 1/8 inch	-	69,85	58,30	54,89	3,40	950
08BS 035	-	2 1/4 inch	-	70,36	61,09	58,04	3,40	740
08BS 518	G 2"		-	68,50	62,40	60,50	2,00	448
08BS 036	G 2"		-	73,03	63,63	60,58	3,40	700
UR 60.7-73-3	-		M 60	73,00	63,00	60,70	3,00	780
08BS 037	-	2 1/2 inch	-	77,72	67,44	64,39	3,40	750
08BS 038	G 2 1/4"		-	79,50	69,98	66,68	3,40	670
08BS 039	G 2 1/2"		-	90,30	79,38	76,08	3,40	680

Web: <http://cat.hansa-flex.com/en/UR08BS>

4

08BS 9 FPM

Usit ring centred 08BS9-FPM

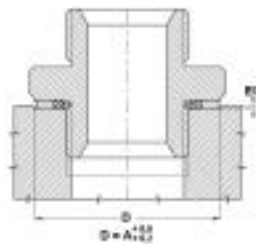
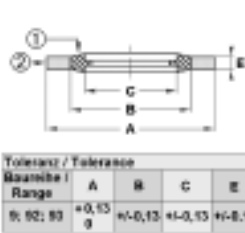

Perfect tightness. Numerous applications possible in static and dynamic sectors, no distortion possible with rotational movements. Numerous applications depending on material. Available for metric, Whitworth and BSP threads.

- Design:** Usit ring
- Construction type:** self-centring
- Temp. min.:** -20 °C
- Temp. max.:** 200 °C
- Installation:** with screws and connecting pieces
- Material:** 1) FPM, (2) Cadmium-plated or passivated carbon steel

Identification	for thread	for thread	A	B	C	E	Pressure PB
			mm	mm	mm	mm	bar
08BS 921 FPM	G 1/4"	1/2 inch	20,57	15,21	13,74	2,10	1550
08BS 923 FPM	G 3/8"		23,80	18,75	17,28	2,10	1260
08BS 925 FPM	G 1/2"	13/16 inch	28,58	23,01	21,54	2,40	1150
08BS 927 FPM	G 3/4"	1 inch	34,93	28,53	27,05	2,40	1060
08BS 929 FPM	G 7/8"	1 3/16 inch	38,10	32,29	30,81	2,40	900
08BS 930 FPM	G 1"	1 5/16 inch	42,80	36,88	33,89	2,50	790
08BS 932 FPM	G 1.1/4"	1 5/8 inch	52,38	45,93	42,93	2,50	690

Web: <http://cat.hansa-flex.com/en/08BS9FPM>

Usit ring centred 08BS9

Perfect tightness. Numerous applications possible in static and dynamic sectors, no distortion possible with rotational movements. Numerous applications depending on material. Available for metric, Whitworth and BSP threads.

- Design:** Usit ring
- Construction type:** self-centring
- Temp. min.:** -30 °C
- Temp. max.:** 110 °C
- Installation:** with screws and connecting pieces
- Material:** 1) NBR 90 Shore A, (2) Cadmium-plated or passivated carbon steel

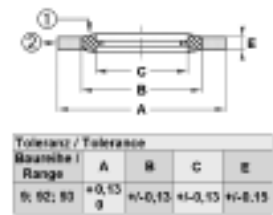
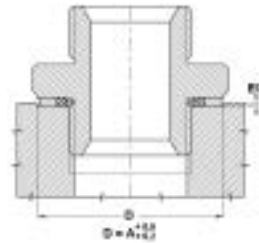

Identification	for thread	for thread	for thread	Dimensions				Pressure PB
				A	B	C	E	
				mm	mm	mm	mm	bar
08BS 920	G 1/8"	3/8 inch	-	15,88	11,84	10,37	2,10	1500
08BS 921	G 1/4"	1/2 inch	-	20,57	15,21	13,74	2,10	1550
08BS 923	G 3/8"	-	-	23,80	18,75	17,28	2,10	1260
08BS 925	G 1/2"	13/16 inch	-	28,58	23,10	21,54	2,40	1150
08BS 926	G 5/8"	7/8 inch	-	31,75	24,97	23,49	2,40	1250
08BS 927	G 3/4"	1 inch	-	34,93	28,53	27,05	2,40	1060
08BS 929	G 7/8"	1 3/16 inch	-	38,10	32,29	30,81	2,40	900
08BS 930	G 1"	1 5/16 inch	-	42,80	36,88	33,89	3,40	790
08BS 932	G 1.1/4"	1 5/8 inch	-	52,38	45,93	42,93	3,40	690
08BS 933	G 1.1/2"	1 7/8 inch	-	58,60	51,39	48,44	3,40	690
08BS 936	G 2"	-	-	73,03	63,63	60,53	3,40	700
08BS 938	G 2 1/4"	-	-	79,50	69,98	66,68	3,25	670
08BS 939	G 2 1/2"	-	-	90,30	79,38	76,08	3,25	680
08BS 9202	-	M 4	-	7,00	5,40	4,50	1,00	1270
08BS 9204	-	M 5	-	10,00	7,40	5,70	1,00	1510
08BS 9203	-	M 5	-	9,00	6,80	5,70	1,00	1400
08BS 9206	-	M 6	-	10,00	8,00	6,70	1,00	1130
08BS 9207	-	M 6	-	11,00	8,20	6,70	1,00	1510
08BS 9212	-	M 8	-	13,00	10,00	8,70	1,00	1330
08BS 9213	-	M 8	-	14,00	10,40	8,70	1,00	1550
08BS 9215	-	M 9	-	13,30	10,50	9,30	1,00	1200
08BS 9216	-	M 10	-	16,00	12,00	10,35	2,00	1470
08BS 9217	-	M 10	-	16,00	12,40	10,70	1,50	1350
08BS 9218	-	M 10	-	18,00	12,40	10,70	1,50	1880
08BS 9221	-	M 11	-	19,10	13,50	11,80	1,50	1250
08BS 9222	-	M 12	-	18,00	14,40	12,70	1,50	1250
08BS 9225	-	M 13	-	22,00	15,40	13,70	1,50	1810
08BS 9227	-	M 14	-	22,00	16,40	14,70	1,50	1510
08BS 9229	-	M 16	-	24,00	18,40	16,70	1,50	1400
08BS 9230	-	M 17	-	24,00	19,20	17,40	1,50	1150
08BS 9232	-	M 18	-	26,00	20,40	18,70	1,50	1275
08BS 9233	-	M 20	-	28,00	22,40	20,70	1,50	1150
08BS 9236	-	M 22	-	30,00	24,40	22,70	2,00	1100
08BS 9238	-	M 24	-	32,00	26,40	24,70	2,00	1050
08BS 9239	-	M 26	-	35,00	28,40	26,70	2,00	1050
08BS 9240	-	M 27	-	36,00	29,00	27,70	2,00	1130
08BS 9243	-	M 33	-	42,00	35,80	33,70	2,00	900
08BS 9245	-	M 36	-	46,00	38,80	36,70	2,00	890

Web: <http://cat.hansa-flex.com/en/08BS9>

**FS**

Seal for SAE and ISO flanges



**Operating pressure:** up to 500 bar  
**Temp. min.:** -40 °C  
**Temp. max.:** 120 °C  
**Media:** Mineral oils  
**Material:** Polyurethane 93 Shore A

Identification	Flange size	d1 mm	d2 mm	S mm
FS-08	1/2"	18,40	25,40	3,53
FS-12	3/4"	24,80	31,80	3,53
FS-16	1"	32,70	39,70	3,53
FS-20	1.1/4"	37,50	44,50	3,53
FS-24	1.1/2"	46,80	53,80	3,53
FS-32	2"	56,40	63,40	3,53
FS-40	2.1/2"	69,40	76,20	3,53
FS-48	3"	85,30	91,90	3,53

**Web:** <http://cat.hansa-flex.com/en/FSDIT>

4

**FS-BOX**

Seal box for SAE and ISO flanges, SET

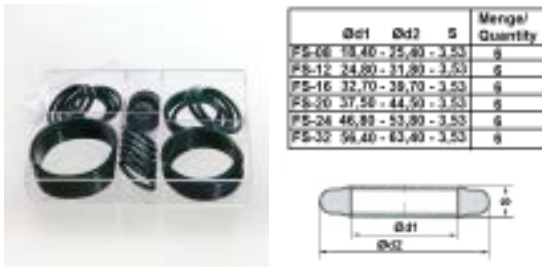

**Operating pressure:** up to 500 bar  
**Temp. min.:** -40 °C  
**Temp. max.:** 120 °C  
**Media:** Mineral oils  
**Material:** Polyurethane 93 Shore A

Ød1	Ød2	S	Menge/ Quantity
FS-08 18,40 - 25,40 - 3,53			6
FS-12 24,80 - 31,80 - 3,53			6
FS-16 32,70 - 39,70 - 3,53			6
FS-20 37,50 - 44,50 - 3,53			6
FS-24 46,80 - 53,80 - 3,53			6
FS-32 56,40 - 63,40 - 3,53			6

Identification	Flange size
FS-BOX	1/2" - 2"

**Web:** <http://cat.hansa-flex.com/en/FSBOXDIT>

**SFS**

SAE flange seal SFS

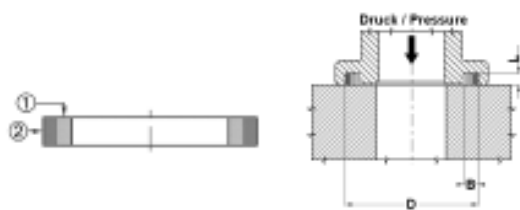

Good extrusion resistance. Long service life. Easy assembly because the seal and flange adhere to each other.

**Operating pressure:** to 420 bar (6000PSI)  
**Colour:** yellow + black  
**Temp. min.:** -35 °C  
**Temp. max.:** 110 °C  
**Media:** Mineral oils  
**Installation:** on SAE flange 3000 and 6000 PSI  
**Material:** 1) Polyurethane 57 Shore A, (2) Polyurethane 95 Shore A

Identification	Flange size	D mm	e mm	B mm
SFS - 08	1/2"	25,4	2,85	4,2
SFS - 12	3/4"	31,8	2,85	4,2
SFS - 16	1"	39,7	2,85	4,2
SFS - 20	1.1/4"	44,5	2,85	4,2
SFS - 24	1.1/2"	53,8	2,85	4,2
SFS - 32	2"	63,4	2,85	4,2



(Continued)

SFS

## SAE flange seal SFS

Identification	Flange size	D mm	e mm	B mm
SFS - 40	2.1/2"	76,2	2,85	4,2
SFS - 48	3"	91,9	2,85	4,2

**Web:** <http://cat.hansa-flex.com/en/SFS>

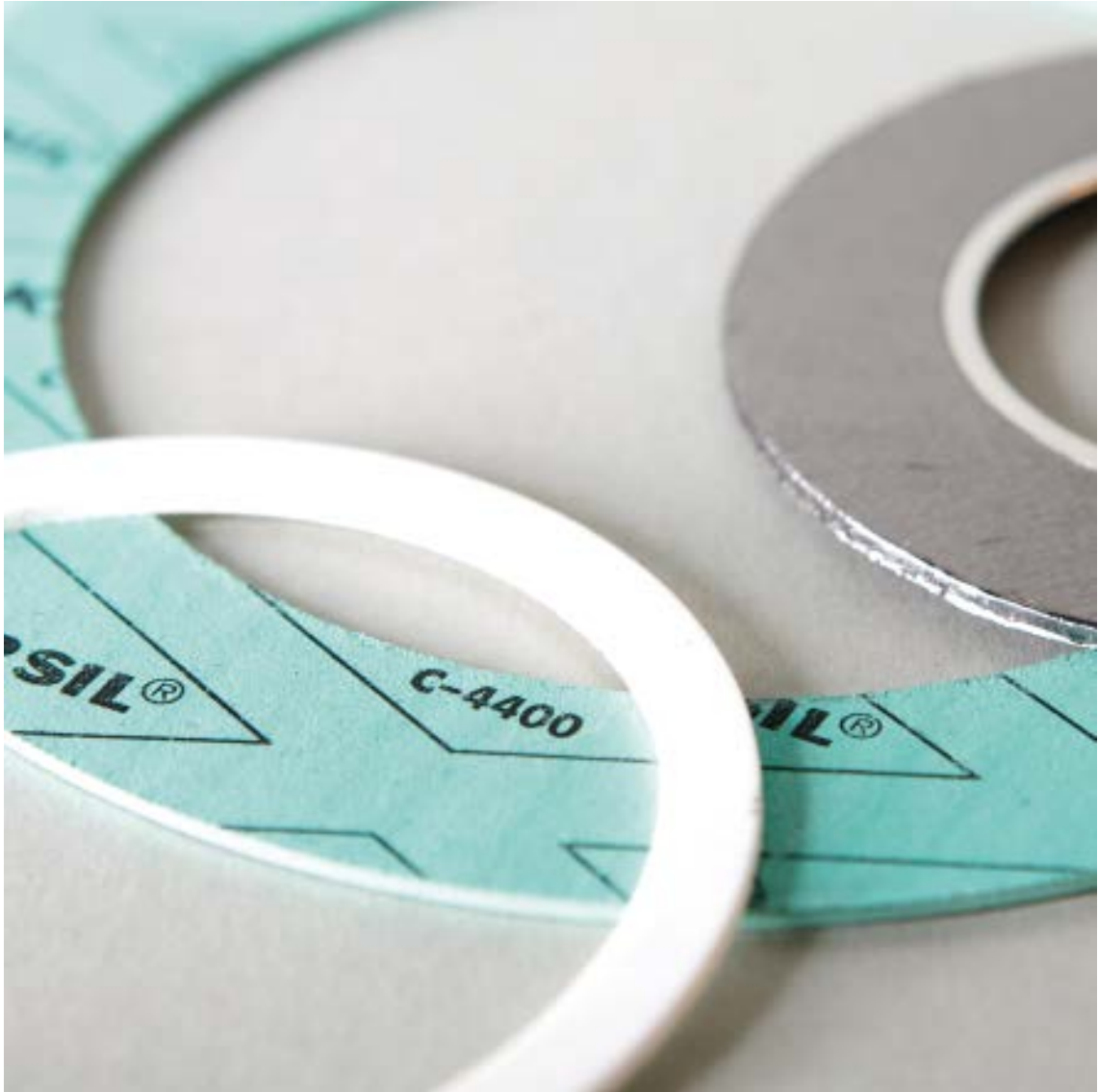

## Flat seals

**Flat seals asbestos-free**

Flat seals FD C4400	202
Flat seals FD	203
Sealing plates	204
Flat seals graphite/serrated perforated plate	204

## FD C4400

## Flat seal

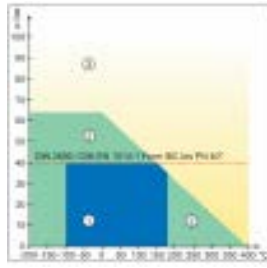

Technical values for 2 mm thickness:

- compressibility ASTM F36 A = 11%
- resilience ASTM F36 A = 55 %
- creep resistance under load DIN 52913 = 25 MPA (50 MPA, 16 h / 300 °C)
- creep resistance under load BS 7531 = 23 MPA
- Thinning at 23 °C = 10 %
- Thinning at 300 °C = 22 %
- leak tightness according to DIN 3535/6 = 0.2 ml/min
- anti-corrosion aptitude (chloride content soluble) = 150 ppm
- Thickness change according to ASTM F 146 (oil JRM 903: 5 h / 23 °C) = 3 %
- Thickness change according to ASTM F 146 (fuel B: 5 h / 23 °C) = 5 %
- density = 1.6 g/cm<sup>3</sup>

**Design:** Universal high-pressure seal for a wide range of sectors

**Construction type:** ultra high-performance standard

**Approval:** DIN-DVGW approval, BAM-, HTB approved, KTW recommended, WRC approval

**Media:** Oil, Water, Steam, Gases, Saline solutions, Fuels, Alcohols, organic and inorganic acids, hydrocarbons, Lubricants, Refrigerants

**Material:** aramid fibres, bonded with NBR

**Application:** food processing, drinking water supply, Chemical industry

**Note:** Tolerances:  
 longitudinal dimension according to DIN 7715 - Part 5 P2,  
 thickness according to DIN 7715 - Part 5 P3,  
 surface seals according to DIN 2690 are only standardized to PN 40 bar

Identification	D mm	d mm	S mm
FD 15-11-1 C4400	15,0	11,00	1,00
FD 41-33.2-2 C4400	41,0	33,20	3,00
FD 55-41-1.5 C4400	55,0	41,00	1,50
FD 60-20-3 C4400	60,0	20,00	3,00
FD 70-45-3 C4400	70,0	45,00	3,00
FD 82-66-1 C4400	82,0	66,00	3,00
FD 85-70-0.5 C4400	85,0	70,00	0,50
FD 90-40-3 C4400	90,0	40,00	3,00
FD 100-50-3 C4400	100,0	50,00	3,00
FD 105-65-3 C4400	105,0	65,00	3,00
FD 110-75-2 C4400	110,0	75,00	2,00
FD 110-85-3 C4400	110,0	85,00	3,00
FD 140-121-1.5 C44	140,0	121,00	1,50
FD 140-121-1.5 C4400	140,0	121,00	1,50
FD 190-125-3 C4400	190,0	125,00	3,00
FD 220-150-3 C4400	220,0	150,00	3,00

Identification	D mm	d mm	S mm
FD 270-200-3 C4400	270,0	200,00	3,00
FD 280-162-2 C4400	280,0	162,00	2,00
FD 310-295-0.5 C44	310,0	295,00	0,50
FD 310-295-0.5 C4400	310,0	295,00	0,50
FD 320-250-3 C4400	320,0	250,00	3,00
FD 380-300-3 C4400	380,0	300,00	3,00
FD 380-325-2 C4400	380,0	325,00	3,00
FD 485-400-3 C4400	485,0	400,00	3,00
FD 540-490-3 C4400	540,0	490,00	3,00
FD 570-500-3 C4400	570,0	500,00	3,00
FD 590-500-3 C4400	590,0	500,00	3,00
FD 680-600-3 C4400	680,0	600,00	3,00
FD 800-670-3 C4400	800,0	670,00	3,00
FD 1080-1010-3 C44	1080,0	1010,00	3,00
FD 1080-1010-3 C4400	1080,0	1010,00	3,00

**Web:** <http://cat.hansa-flex.com/en/FDC4400>

## FDDN PN C4400

## Flat seal, DIN2690 asbestos-free

Technical values for 2 mm thickness:

- compressibility ASTM F36 A = 11%
- resilience ASTM F36 A = 55 %
- creep resistance under load DIN 52913 = 25 MPA (50 MPA, 16 h / 300 °C)
- creep resistance under load BS 7531 = 23 MPA
- Thinning at 23 °C = 10 %
- Thinning at 300 °C = 22 %
- leak tightness according to DIN 3535/6 = 0.2 ml/min
- anti-corrosion aptitude (chloride content soluble) = 150 ppm
- Thickness change according to ASTM F 146 (oil JRM 903: 5 h / 23 °C) = 3 %
- Thickness change according to ASTM F 146 (fuel B: 5 h / 23 °C) = 5 %
- density = 1.6 g/cm<sup>3</sup>

**Design:** Universal high-pressure seal for a wide range of sectors

**Construction type:** ultra high-performance standard

**Approval:** DIN-DVGW approval, BAM-, HTB approved, KTW recommended, WRC approval

**Media:** Oil, Water, Steam, Gases, Saline solutions, Fuels, Alcohols, organic and inorganic acids, hydrocarbons, Lubricants, Refrigerants

**Material:** aramid fibres, bonded with NBR

**Application:** Chemical industry, food processing, drinking water supply

**Note:** Tolerances:

longitudinal dimension according to DIN 7715 - Part 5 P2,

thickness according to DIN 7715 - Part 5 P3,

surface seals according to DIN 2690 are only standardized to PN 40 bar

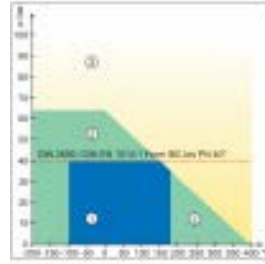

Identification	D	d	S
	mm	mm	mm
FD DN10 PN40 C4400	45,0	18,00	2,00
FD DN15 PN40 C4400	50,0	22,00	2,00
FD DN20 PN40 C4400	61,0	27,00	2,00
FD DN25 PN40 C4400	70,0	35,00	2,00
FD DN32 PN16 C4400	82,0	43,00	2,00
FD DN40 PN40 C4400	92,0	49,00	2,00
FD DN50 PN40 C4400	107,0	61,00	2,00
FD DN65 PN40 C4400	127,0	77,00	2,00
FD DN80 PN40 C4400	142,0	90,00	3,00
FD DN100 PN16 C4400	162,0	115,00	2,00
FD DN125 PN16 C4400	192,0	141,00	2,00
FD DN150 PN16 C4400	218,0	169,00	2,00
FD DN150 PN40 C4400	225,0	168,00	2,00
FD DN200 PN16 C4400	273,0	220,00	3,00
FD DN250 PN16 C4400	328,0	274,00	3,00
FD DN500 PN10 C4400	595,0	520,00	3,00

**Web:** <http://cat.hansa-flex.com/en/FDDNPNC4400>

**PLATTE C4400**

## Sealing plate, asbestos-free

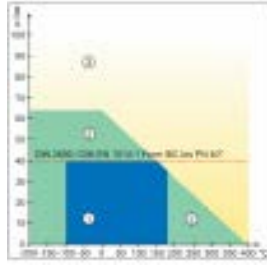

Technical values for 2 mm thickness:

- compressibility ASTM F36 A = 11%
- resilience ASTM F36 A = 55 %
- creep resistance under load DIN 52913 = 25 MPA (50 MPA, 16 h / 300 °C)
- creep resistance under load BS 7531 = 23 MPA
- Thinning at 23 °C = 10 %
- Thinning at 300 °C = 22 %
- leak tightness according to DIN 3535/6 = 0.2 ml/min
- anti-corrosion aptitude (chloride content soluble) = 150 ppm
- Thickness change according to ASTM F 146 (oil JRM 903: 5 h / 23 °C) = 3 %
- Thickness change according to ASTM F 146 (fuel B: 5 h / 23 °C) = 5 %
- density = 1.6 g/cm<sup>3</sup>

**Design:** Universal high-pressure seal for a wide range of sectors  
**Construction type:** ultra high-performance standard  
**Media:** Oil, Water, Steam, Gases, Saline solutions, Fuels, Alcohols, organic and inorganic acids, hydrocarbons, Lubricants, Refrigerants  
**Material:** aramid fibres, bonded with NBR  
**Application:** food processing, drinking water supply, Chemical industry

**Note:** Tolerances:  
 longitudinal dimension according to DIN 7715 - Part 5 P2,  
 thickness according to DIN 7715 - Part 5 P3,  
 surface seals according to DIN 2690 are only standardized to PN 40 bar

Identification	S
	mm
PLATTE C4400X0.5	0,50
PLATTE C4400X1.0	1,00
PLATTE C4400X1.5	1,50
PLATTE C4400X2.0	2,00
PLATTE C4400X2.5	2,50
PLATTE C4400X3.0	3,00

**Web:** <http://cat.hansa-flex.com/en/PLATTEC4400>

**BOERD DI PN16**

## Sealing DIN2690 graphite/serrated perforated plate



**Note:** Tolerances:  
 longitudinal dimension according to DIN 7715 - Part 5 P2,  
 thickness according to DIN 7715 - Part 5 P3,

Identification	D	d	s
	mm	mm	mm
BOERD DI DN15 PN16	50,0	22,00	2,0
BOERD DI DN20 PN16	60,0	28,00	2,0
BOERD DI DN25 PN16	70,0	35,00	2,0
BOERD DI DN32 PN16	82,0	43,00	2,0
BOERD DI DN40 PN16	92,0	49,00	2,0
BOERD DI DN50 PN16	107,0	61,00	2,0
BOERD DI DN65 PN16	127,0	77,00	2,0
BOERD DI DN100 PN16	162,0	115,00	2,0
BOERD DI DN125 PN16	192,0	141,00	2,0
BOERD DI DN150 PN16	218,0	169,00	2,0
BOERD DI DN175 PN10	248,0	195,00	2,0
BOERD DI DN200 PN16	273,0	220,00	2,0
BOERD DI DN250 PN16	330,0	274,00	2,0
BOERD DI DN300 PN16	385,0	325,00	2,0
BOERD DI DN350 PN16	445,0	368,00	2,0
BOERD DI DN400 PN16	497,0	420,00	2,0
BOERD DI DN450 PN16	557,0	470,00	2,0

**Web:** <http://cat.hansa-flex.com/en/BOERDDIPN16>

**FLAT SEALS – GRAPHITE WITHOUT GLUE (GRAPHITE / SERRATED PERFORATED PLATE)****Material profile**

Made of expanded graphite reinforced with perforated stainless steel SUS316 (0.10 mm thick), used as seal material

**Typical use**

High thermal and mechanical loads, frequently changing loads; saturated steam, superheated steam, oil as heat carrier.

Properties	Standard	Unit	Values		
Thickness		mm	1.0	2.0	3.0
Density (graphite)		g/cm <sup>3</sup>	1.0	1.0	1.0
Compressibility	ASTM F36/A	%	35-50	35-50	35-50
Recovery	ASTM F36/A	%	10-20	10-20	10-20
Leakage rate	DIN 3535	ml/min	≤ 1.0	≤ 1.0	≤ 1.0
<b>Temperature</b>					
Max. temperature inert atmosphere		°C	2500	2500	2500
Continual work temp. (with oxidation)		°C	250	250	250
Short-term max. work temp. (inert atmosphere)		°C	550	550	550
<b>Fluid resistant</b>					
ASTM F146					
ASTM 3 oil 150 °C, 5 h					
Weight increase		%	< 15	< 15	< 15
Thickness increase		%	≤ 6	≤ 6	≤ 6
LLC50% 100 °C, 22 h					
Weight increase		%	<15	<15	15
Thickness increase		%	≤ 6	≤ 6	≤ 6
Sulphur content	ASTM C816	ppm	≈ 1300	≈ 1300	≈ 1300
Leachable chloride content	ASTM F1277	ppm	≤ 50	≤ 50	≤ 50
Carbon content	JB/T 914	%	≥ 98.5	≥ 98.5	≥ 98.5
Fluoride content		ppm	≤ 30	≤ 30	≤ 30



6

## Sealing rings



<b>Aluminium</b>	
Aluminium sealing rings	208
<b>Copper</b>	
Copper sealing rings	210
CAR sealing rings	213
<b>Vulcanised fibre</b>	
Vulcanised fibre sealing rings	215

**ALR (1,0 mm)**

**Aluminium sealing ring**

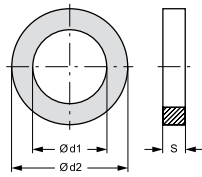

**Material:** Aluminium

Identification	d1 mm	d2 mm	S mm
ALR 4-8-1	4,00	8,00	1,00
ALR 5-7.5-1	5,00	7,50	1,00
ALR 5-9-1	5,00	9,00	1,00
ALR 6-10-1	6,00	10,00	1,00
ALR 6-12-1	6,00	12,00	1,00
ALR 6.5-9.5-1	6,50	9,50	1,00
ALR 8-11.5-1	8,00	11,50	1,00

Identification	d1 mm	d2 mm	S mm
ALR 8-12-1	8,00	12,00	1,00
ALR 8-13-1	8,00	13,00	1,00
ALR 8-14-1	8,00	14,00	1,00
ALR 10-13.5-1	10,50	13,50	1,00
ALR 10-14-1	10,50	14,00	1,00
ALR 10-15-1	10,50	15,00	1,00
ALR 10-16-1	10,00	16,00	1,00

**Web:** <http://cat.hansa-flex.com/en/ALR10MM>

**ALR (1,5 mm)**

**Aluminium sealing ring**

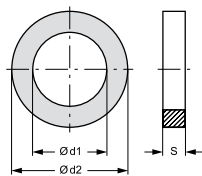

**Material:** Aluminium

Identification	d1 mm	d2 mm	S mm
ALR 12-15-1.5	12,00	15,00	1,50
ALR 12-16-1.5	12,00	16,00	1,50
ALR 12-17-1.5	12,00	17,00	1,50
ALR 12-18-1.5	12,00	18,00	1,50
ALR 12-19-1.5	12,00	19,00	1,50
ALR 13-18-1.5	13,00	18,00	1,50
ALR 14-18-1.5	14,00	18,00	1,50
ALR 14-20-1.5	14,00	20,00	1,50
ALR 14-22-1.5	14,00	22,00	1,50
ALR 15-19-1.5	15,00	19,00	1,50
ALR 15-24-1.5	15,00	24,00	1,50
ALR 16-20-1.5	16,00	20,00	1,50

Identification	d1 mm	d2 mm	S mm
ALR 16-22-1.5	16,00	22,00	1,50
ALR 17-21-1.5	17,00	21,00	1,50
ALR 17-23-1.5	17,00	23,00	1,50
ALR 18-22-1.5	18,00	22,00	1,50
ALR 18-24-1.5	18,00	24,00	1,50
ALR 20-24-1.5	20,00	24,00	1,50
ALR 20-26-1.5	20,00	26,00	1,50
ALR 21-26-1.5	21,00	26,00	1,50
ALR 21-28-1.5	21,00	28,00	1,50
ALR 22-27-1.5	22,00	27,00	1,50
ALR 22-29-1.5	22,00	29,00	1,50

**Web:** <http://cat.hansa-flex.com/en/ALR15MM>

## ALR (2,0 mm)

## Aluminium sealing ring

Material: Aluminium

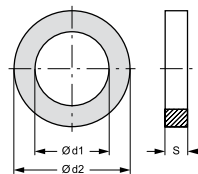

Identification	d1 mm	d2 mm	S mm
ALR 13-18-2	13,00	18,00	2,00
ALR 24-29-2	24,00	29,00	2,00
ALR 24-30-2	24,00	30,00	2,00
ALR 24-32-2	24,00	32,00	2,00
ALR 26-31-2	26,00	31,00	2,00
ALR 26-32-2	26,00	32,00	2,00
ALR 26-34-2	26,00	34,00	2,00
ALR 27-32-2	27,00	32,00	2,00
ALR 28-34-2	28,00	34,00	2,00
ALR 28-36-2	28,00	36,00	2,00
ALR 30-36-2	30,00	36,00	2,00

Identification	d1 mm	d2 mm	S mm
ALR 30-38-2	30,00	38,00	2,00
ALR 32-38-2	32,00	38,00	2,00
ALR 33-39-2	33,00	39,00	2,00
ALR 35-41-2	35,00	41,00	2,00
ALR 36-42-2	36,00	42,00	2,00
ALR 38-44-2	38,00	44,00	2,00
ALR 40-47-2	40,00	47,00	2,00
ALR 42-49-2	42,00	49,00	2,00
ALR 45-52-2	45,00	52,00	2,00
ALR 48-55-2	48,00	55,00	2,00
ALR 50-57-2	50,00	57,00	2,00

Web: <http://cat.hansa-flex.com/en/ALR20MM>

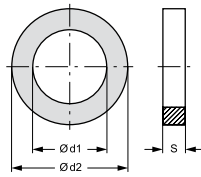
**CR (1,0 mm)****Copper sealing ring, 1 mm thick**

**Design:** Sealing ring  
**Temp. min.:** -50 °C  
**Temp. max.:** 300 °C  
**Material:** Copper

Identification	d1 mm	d2 mm	S mm
CR 4-8-1	4,00	8,00	1,00
CR 5-7-5-1	5,00	7,50	1,00
CR 5-8-1	5,00	8,00	1,00
CR 5-9-1	5,00	9,00	1,00
CR 5-10-1	5,00	10,00	1,00
CR 5-5-8-1	5,50	8,00	1,00
CR 6-10-1	6,00	10,00	1,00
CR 6-12-1	6,00	12,00	1,00
CR 6-5-9-5-1	6,50	9,50	1,00
CR 6-5-11-1	6,50	11,00	1,00
CR 8-11-5-1	8,00	11,50	1,00
CR 8-12-1	8,00	12,00	1,00
CR 8-13-1	8,00	13,00	1,00
CR 8-14-1	8,00	14,00	1,00
CR 8-15-1	8,00	15,00	1,00
CR 9-13-1	9,00	13,00	1,00
CR 9-14-1	9,00	14,00	1,00
CR 10-13-1	10,00	13,00	1,00
CR 10-13-5-1	10,00	13,50	1,00
CR 10-14-1	10,00	14,00	1,00
CR 10-15-1	10,00	15,00	1,00
CR 10-16-1	10,00	16,00	1,00
CR 10-17-1	10,00	17,00	1,00
CR 10-18-1	10,00	18,00	1,00
CR 10-20-1	10,00	20,00	1,00
CR 11-17-1	11,00	17,00	1,00
CR 11-20-1	11,00	20,00	1,00
CR 12-15-5-1	12,00	15,50	1,00
CR 12-16-1	12,00	16,00	1,00
CR 12-17-1	12,00	17,00	1,00

Identification	d1 mm	d2 mm	S mm
CR 12-18-1	12,00	18,00	1,00
CR 12-20-1	12,00	20,00	1,00
CR 13-17-1	13,00	17,00	1,00
CR 13-18-1	13,00	18,00	1,00
CR 13-19-1	13,00	19,00	1,00
CR 13-20-1	13,00	20,00	1,00
CR 14-18-1	14,00	18,00	1,00
CR 14-20-1	14,00	20,00	1,00
CR 14-24-1	14,00	24,00	1,00
CR 15-20-1	15,00	20,00	1,00
CR 16-5-24-1	16,50	24,00	1,00
CR 16-20-1	16,00	20,00	1,00
CR 16-22-1	16,00	22,00	1,00
CR 17-21-1	17,00	21,00	1,00
CR 17-22-1	17,00	22,00	1,00
CR 17-23-1	17,00	23,00	1,00
CR 18-22-1	18,00	22,00	1,00
CR 18-24-1	18,00	24,00	1,00
CR 20-24-1	20,00	24,00	1,00
CR 20-26-1	20,00	26,00	1,00
CR 21-26-1	21,00	26,00	1,00
CR 21-27-1	21,00	27,00	1,00
CR 21-28-1	21,00	28,00	1,00
CR 21-30-1	21,00	30,00	1,00
CR 22-27-1	22,00	27,00	1,00
CR 22-28-1	22,00	28,00	1,00
CR 22-29-1	22,00	29,00	1,00
CR 24-30-1	24,00	30,00	1,00
CR 26-30-1	26,00	30,00	1,00
CR 30-36-1	30,00	36,00	1,00

**Web:** <http://cat.hansa-flex.com/en/CR10MM>

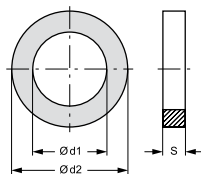
**CR (1,5 mm)****Copper sealing ring, 1.5 mm thick**

**Design:** Sealing ring  
**Temp. min.:** -50 °C  
**Temp. max.:** 300 °C  
**Material:** Copper

Identification	d1 mm	d2 mm	S mm
CR 5-9-1.5	5,00	9,00	1,50
CR 5-11-1.5	5,00	11,00	1,50
CR 6-10-1.5	6,00	10,00	1,50
CR 6-12-1.5	6,00	12,00	1,50
CR 8-11-5-1.5	8,00	11,50	1,50
CR 8-12-1.5	8,00	12,00	1,50
CR 8-13-1.5	8,00	13,00	1,50
CR 8-14-1.5	8,00	14,00	1,50
CR 9-14-1.5	9,00	14,00	1,50
CR 10-13-5-1.5	10,00	13,50	1,50
CR 10-14-1.5	10,00	14,00	1,50
CR 10-15-1.5	10,00	15,00	1,50
CR 10-16-1.5	10,00	16,00	1,50
CR 10-17-1.5	10,00	17,00	1,50
CR 10-18-1.5	10,00	18,00	1,50
CR 10-20-1.5	10,00	20,00	1,50
CR 11-17-1.5	11,00	17,00	1,50
CR 12-15-5-1.5	12,00	15,50	1,50
CR 12-16-1.5	12,00	16,00	1,50
CR 12-17-1.5	12,00	17,00	1,50

Identification	d1 mm	d2 mm	S mm
CR 12-18-1.5	12,00	18,00	1,50
CR 12-19-1.5	12,00	19,00	1,50
CR 12-20-1.5	12,00	20,00	1,50
CR 13-17-1.5	13,00	17,00	1,50
CR 13-18-1.5	13,00	18,00	1,50
CR 13-19-1.5	13,00	19,00	1,50
CR 13-20-1.5	13,00	20,00	1,50
CR 13-5-17-5-1.5	13,50	17,50	1,50
CR 14-18-1.5	14,00	18,00	1,50
CR 14-20-1.5	14,00	20,00	1,50
CR 14-22-1.5	14,00	22,00	1,50
CR 14-23-1.5	14,00	23,00	1,50
CR 14-24-1.5	14,00	24,00	1,50
CR 15-19-1.5	15,00	19,00	1,50
CR 15-20-1.5	15,00	20,00	1,50
CR 16-20-1.5	16,00	20,00	1,50
CR 16-21-1.5	16,00	21,00	1,50
CR 16-22-1.5	16,00	22,00	1,50
CR 16-24-1.5	16,00	24,00	1,50
CR 16-5-22-1.5	16,50	22,00	1,50



(Continued)

CR (1,5 mm)

## Copper sealing ring, 1.5 mm thick

Identification	d1 mm	d2 mm	S mm
CR 16.5-23-1.5	16,50	23,00	1,50
CR 16.5-24-1.5	16,50	24,00	1,50
CR 17-21-1.5	17,00	21,00	1,50
CR 17-22-1.5	17,00	22,00	1,50
CR 17-23-1.5	17,00	23,00	1,50
CR 17-25-1.5	17,00	25,00	1,50
CR 18-22-1.5	18,00	22,00	1,50
CR 18-23-1.5	18,00	23,00	1,50
CR 18-24-1.5	18,00	24,00	1,50
CR 18-26-1.5	18,00	26,00	1,50
CR 19-25-1.5	19,00	25,00	1,50
CR 20-24-1.5	20,00	24,00	1,50
CR 20-26-1.5	20,00	26,00	1,50
CR 20-28-1.5	20,00	28,00	1,50
CR 21-25-1.5	21,00	25,00	1,50
CR 21-26-1.5	21,00	26,00	1,50
CR 21-27-1.5	21,00	27,00	1,50
CR 21-28-1.5	21,00	28,00	1,50
CR 22-26-1.5	22,00	26,00	1,50
CR 22-27-1.5	22,00	27,00	1,50

Identification	d1 mm	d2 mm	S mm
CR 22-28-1.5	22,00	28,00	1,50
CR 22-29-1.5	22,00	29,00	1,50
CR 23-30-1.5	23,00	30,00	1,50
CR 24-29-1.5	24,00	29,00	1,50
CR 24-30-1.5	24,00	30,00	1,50
CR 24-32-1.5	24,00	32,00	1,50
CR 26-31-1.5	26,00	31,00	1,50
CR 26-32-1.5	26,00	32,00	1,50
CR 26-34-1.5	26,00	34,00	1,50
CR 27-32-1.5	27,00	32,00	1,50
CR 27-35-1.5	27,00	35,00	1,50
CR 30-36-1.5	30,00	36,00	1,50
CR 30-38-1.5	30,00	38,00	1,50
CR 32-38-1.5	32,00	38,00	1,50
CR 33-39-1.5	33,00	39,00	1,50
CR 35-41-1.5	35,00	41,00	1,50
CR 36-42-1.5	36,00	42,00	1,50
CR 38-46-1.5	38,00	46,00	1,50
CR 42-51-1.5	42,00	51,00	1,50

Web: <http://cat.hansa-flex.com/en/CR15MM>

CR (2,0 mm)

## Copper sealing ring, 2 mm thick

**Design:** Sealing ring  
**Temp. min.:** -50 °C  
**Temp. max.:** 300 °C  
**Material:** Copper

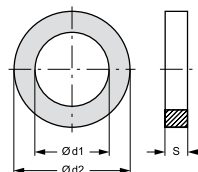

Identification	d1 mm	d2 mm	S mm
CR 5-9-2	5,00	9,00	2,00
CR 6-10-2	6,00	10,00	2,00
CR 6-12-2	6,00	12,00	2,00
CR 6.2-17.5-2	6,20	17,50	2,00
CR 8-11.5-2	8,00	11,50	2,00
CR 8-12-2	8,00	12,00	2,00
CR 8-13-2	8,00	13,00	2,00
CR 8-14-2	8,00	14,00	2,00
CR 8-19-2	8,00	19,00	2,00
CR 10-13.5-2	10,00	13,50	2,00
CR 10-14-2	10,00	14,00	2,00
CR 10-15-2	10,00	15,00	2,00
CR 10-16-2	10,00	16,00	2,00
CR 10-18-2	10,00	18,00	2,00
CR 10-20-2	10,00	20,00	2,00
CR 12-16-2	12,00	16,00	2,00
CR 12-17-2	12,00	17,00	2,00
CR 12-18-2	12,00	18,00	2,00
CR 12-20-2	12,00	20,00	2,00
CR 13-17-2	13,00	17,00	2,00
CR 13-18-2	13,00	18,00	2,00
CR 13-19-2	13,00	19,00	2,00
CR 13-20-2	13,00	20,00	2,00
CR 14-18-2	14,00	18,00	2,00
CR 14-20-2	14,00	20,00	2,00
CR 14-22-2	14,00	22,00	2,00
CR 14-24-2	14,00	24,00	2,00
CR 15-20-2	15,00	20,00	2,00
CR 16-20-2	16,00	20,00	2,00
CR 16-21-2	16,00	21,00	2,00
CR 16-22-2	16,00	22,00	2,00
CR 16-24-2	16,00	24,00	2,00
CR 17-21-2	17,00	21,00	2,00
CR 17-22-2	17,00	22,00	2,00
CR 17-23-2	17,00	23,00	2,00
CR 17-25-2	17,00	25,00	2,00
CR 18-22-2	18,00	22,00	2,00
CR 18-23-2	18,00	23,00	2,00
CR 18-24-2	18,00	24,00	2,00
CR 20-24-2	20,00	24,00	2,00
CR 20-26-2	20,00	26,00	2,00
CR 21-26-2	21,00	26,00	2,00
CR 21-27-2	21,00	27,00	2,00

Identification	d1 mm	d2 mm	S mm
CR 21-28-2	21,00	28,00	2,00
CR 22-26-2	22,00	26,00	2,00
CR 22-27-2	22,00	27,00	2,00
CR 22-28-2	22,00	28,00	2,00
CR 22-29-2	22,00	29,00	2,00
CR 23-28-2	23,00	28,00	2,00
CR 23-30-2	23,00	30,00	2,00
CR 24-29-2	24,00	29,00	2,00
CR 24-30-2	24,00	30,00	2,00
CR 24-32-2	24,00	32,00	2,00
CR 25-30-2	25,00	30,00	2,00
CR 25-33-2	25,00	33,00	2,00
CR 26-31-2	26,00	31,00	2,00
CR 26-32-2	26,00	32,00	2,00
CR 26-34-2	26,00	34,00	2,00
CR 26-36-2	26,00	36,00	2,00
CR 26.5-33-2	26,50	33,00	2,00
CR 27-32-2	27,00	32,00	2,00
CR 27-33-2	27,00	33,00	2,00
CR 27-34-2	27,00	34,00	2,00
CR 27-35-2	27,00	35,00	2,00
CR 27-38-2	27,00	38,00	2,00
CR 28-33-2	28,00	33,00	2,00
CR 28-34-2	28,00	34,00	2,00
CR 28-36-2	28,00	36,00	2,00
CR 30-36-2	30,00	36,00	2,00
CR 30-38-2	30,00	38,00	2,00
CR 30-42-2	30,00	42,00	2,00
CR 31-43-2	31,00	43,00	2,00
CR 32-38-2	32,00	38,00	2,00
CR 32-40-2	32,00	40,00	2,00
CR 33-39-2	33,00	39,00	2,00
CR 33-40-2	33,00	40,00	2,00
CR 33-41-2	33,00	41,00	2,00
CR 35-41-2	35,00	41,00	2,00
CR 36-42-2	36,00	42,00	2,00
CR 36-44-2	36,00	44,00	2,00
CR 38-44-2	38,00	44,00	2,00
CR 38-46-2	38,00	46,00	2,00
CR 38-49-2	38,00	49,00	2,00
CR 39-46-2	39,00	46,00	2,00
CR 39-48-2	39,00	48,00	2,00
CR 40-47-2	40,00	47,00	2,00

**CR (2,0 mm)**

(Continued)

**Copper sealing ring, 2 mm thick**

Identification	d1 mm	d2 mm	S mm
CR 40-49-2	40,00	49,00	2,00
CR 42-49-2	42,00	49,00	2,00
CR 44-51-2	44,00	51,00	2,00
CR 45-52-2	45,00	52,00	2,00

Identification	d1 mm	d2 mm	S mm
CR 48-55-2	48,00	55,00	2,00
CR 48-57-2	48,00	57,00	2,00
CR 50-57-2	50,00	57,00	2,00

Web: <http://cat.hansa-flex.com/en/CR20MM>

**CR (2,5 - 3,5 mm)**

**Copper sealing ring, 2.5 - 3.5 mm thick**

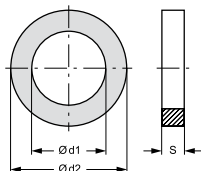

**Design:** Sealing ring  
**Temp. min.:** -50 °C  
**Temp. max.:** 300 °C  
**Material:** Copper

Identification	d1 mm	d2 mm	S mm
CR 6.2-17.5-2.5	6,20	17,50	2,50
CR 11-24-2.5	11,00	24,00	2,50
CR 52-60-2.5	52,00	60,00	2,50
CR 60-68-2.5	60,00	68,00	2,50
CR 64-72-2.5	64,00	72,00	2,50

Identification	d1 mm	d2 mm	S mm
CR 65-74-2.5	65,00	74,00	2,50
CR 75-84-2.5	75,00	84,00	2,50
CR 90-100-2.5	90,00	100,00	2,50
CR 21-27-3	21,00	27,00	3,00
CR 35-42-3.5	35,00	42,00	3,50

Web: <http://cat.hansa-flex.com/en/CR2535MM>

6

**CR SET**

**Copper sealing ring set**



Bezeichnung	Menge	Bezeichnung	Menge
d1 Ød2 S	Quantity	d1 Ød2 S	Quantity
CR 6-12-1,0	28	CR 6-12-1,0	28
CR 8-12-1,0	28	CR 8-14-1,0	28
CR 10-14-1,0	28	CR 10-18-1,0	28
CR 12-14-1,5	28	CR 12-28-1,5	28
CR 14-18-1,5	28	CR 14-28-1,5	28
CR 18-28-1,5	28	CR 17-22-1,5	28
CR 18-24-1,5	28	CR 21-28-1,5	28
CR 22-27-1,5	28	CR 26-28-2,0	28
CR 24-30-2,0	28	CR 26-32-2,0	28
CR 27-32-2,0	28	CR 30-34-2,0	28
CR 30-38-2,0	28	CR 33-39-2,0	28

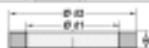

**Design:** Sealing ring  
**Included in scope of supply:** Consisting of 440 parts:  
**Temp. min.:** -250 °C  
**Temp. max.:** 300 °C  
**Material:** Copper

Identification	Dimension
CR SET	340mm x 240mm x 60mm

Web: <http://cat.hansa-flex.com/en/CRSET>

## CAR (1,5 mm)

## Copper ring with asbestos filler, thickness 1,5 mm

Material: Copper

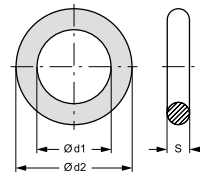

Identification	d1 mm	d2 mm	S mm
CAR 6-10-1.5	6,00	10,00	1,50
CAR 6-12-1.5	6,00	12,00	1,50
CAR 8-11.5-1.5	8,00	11,50	1,50
CAR 8-12-1.5	8,00	12,00	1,50
CAR 8-13-1.5	8,00	13,00	1,50
CAR 8-14-1.5	8,00	14,00	1,50
CAR 10-13.5-1.5	10,00	13,50	1,50
CAR 10-14-1.5	10,00	14,00	1,50
CAR 10-15-1.5	10,00	15,00	1,50
CAR 10-16-1.5	10,00	16,00	1,50

Web: <http://cat.hansa-flex.com/en/CAR15MM>

## CAR (2,0 mm)

## Copper ring with asbestos filler, thickness 2 mm

Material: Copper

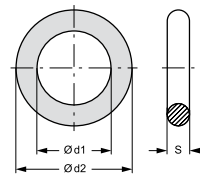

Identification	d1 mm	d2 mm	S mm
CAR 12-15.5-2	12,00	15,50	2,00
CAR 12-16-2	12,00	16,00	2,00
CAR 12-17-2	12,00	17,00	2,00
CAR 12-18-2	12,00	18,00	2,00
CAR 13-18-2	13,00	18,00	2,00
CAR 13-19-2	13,00	19,00	2,00
CAR 14-18-2	14,00	18,00	2,00
CAR 14-20-2	14,00	20,00	2,00
CAR 16-20-2	16,00	20,00	2,00
CAR 16-22-2	16,00	22,00	2,00
CAR 17-21-2	17,00	21,00	2,00
CAR 17-23-2	17,00	23,00	2,00
CAR 18-22-2	18,00	22,00	2,00
CAR 18-24-2	18,00	24,00	2,00
CAR 20-24-2	20,00	24,00	2,00
CAR 20-26-2	20,00	26,00	2,00
CAR 21-26-2	21,00	26,00	2,00
CAR 22-27-2	22,00	27,00	2,00
CAR 22-29-2	22,00	29,00	2,00

Web: <http://cat.hansa-flex.com/en/CAR20MM>

**CAR (2,5 mm)**

Copper ring with asbestos filler, thickness 2,5 mm

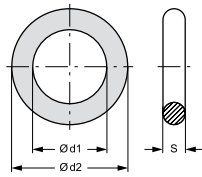
**Material:** Copper

Identification	d1 mm	d2 mm	S mm
CAR 24-29-2.5	24,00	29,00	2,50
CAR 24-30-2.5	24,00	30,00	2,50
CAR 24-32-2.5	24,00	32,00	2,50
CAR 26-31-2.5	26,00	31,00	2,50
CAR 26-32-2.5	26,00	32,00	2,50
CAR 26-34-2.5	26,00	34,00	2,50
CAR 27-32-2.5	27,00	32,00	2,50
CAR 28-34-2.5	28,00	34,00	2,50
CAR 30-36-2.5	30,00	36,00	2,50
CAR 30-38-2.5	30,00	28,00	2,50
CAR 32-38-2.5	32,00	28,00	2,50
CAR 33-39-2.5	33,00	39,00	2,50
CAR 35-41-2.5	35,00	41,00	2,50
CAR 36-42-2.5	36,00	42,00	2,50
CAR 38-44-2.5	38,00	44,00	2,50
CAR 40-47-2.5	40,00	47,00	2,50
CAR 42-49-2.5	42,00	49,00	2,50
CAR 45-52-2.5	45,00	52,00	2,50
CAR 48-55-2.5	48,00	55,00	2,50

**Web:** <http://cat.hansa-flex.com/en/CAR25MM>

6

**CAR (3,0 mm)**

Copper ring with asbestos filler, thickness 3 mm

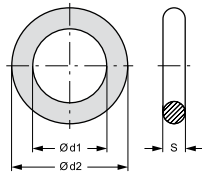
**Material:** Copper

Identification	d1 mm	d2 mm	S mm
CAR 52-60-3	52,00	60,00	3,00
CAR 60-68-3	60,00	68,00	3,00

**Web:** <http://cat.hansa-flex.com/en/CAR30MM>



## VFR (1,0 mm)

## Vulcanised fibre sealing ring, 1 mm thick

**Standard:** DIN 7603-A  
**Material:** Vulcanised fibre

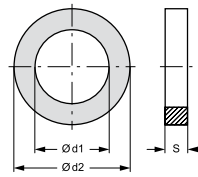

Identification	d1 mm	d2 mm	S mm
VFR 4-8-1	4,00	8,00	1,00
VFR 5-9-1	5,00	9,00	1,00
VFR 6-10-1	6,00	10,00	1,00
VFR 8-12-1	8,00	12,00	1,00

Identification	d1 mm	d2 mm	S mm
VFR 8-14-1	8,00	14,00	1,00
VFR 10-14-1	10,00	14,00	1,00
VFR 10-16-1	10,00	16,00	1,00
VFR 13-18-1	13,00	18,00	1,00

**Web:** <http://cat.hansa-flex.com/en/VFR10MM>

## VFR (1,5 mm)

## Vulcanised fibre sealing ring, 1.5 mm thick

**Standard:** DIN 7603-A  
**Material:** Vulcanised fibre

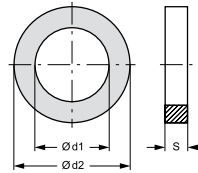

Identification	d1 mm	d2 mm	S mm
VFR 5-11-1.5	5,00	11,00	1,50
VFR 12-16-1.5	12,00	16,00	1,50
VFR 12-17-1.5	12,00	17,00	1,50
VFR 12-18-1.5	12,00	18,00	1,50
VFR 12-19-1.5	12,00	19,00	1,50
VFR 12-20-1.5	12,00	20,00	1,50
VFR 12-22-1.5	12,00	22,00	1,50
VFR 13-18-1.5	13,00	18,00	1,50
VFR 13-20-1.5	13,00	20,00	1,50
VFR 14-18-1.5	14,00	18,00	1,50
VFR 14-20-1.5	14,00	20,00	1,50
VFR 14-22-1.5	14,00	22,00	1,50
VFR 14-24-1.5	14,00	24,00	1,50
VFR 15-19-1.5	15,00	19,00	1,50

Identification	d1 mm	d2 mm	S mm
VFR 15-24-1.5	15,00	24,00	1,50
VFR 16-20-1.5	16,00	20,00	1,50
VFR 16-22-1.5	16,00	22,00	1,50
VFR 17-21-1.5	17,00	21,00	1,50
VFR 17-23-1.5	17,00	23,00	1,50
VFR 18-22-1.5	18,00	22,00	1,50
VFR 18-24-1.5	18,00	24,00	1,50
VFR 20-24-1.5	20,00	24,00	1,50
VFR 20-26-1.5	20,00	26,00	1,50
VFR 21-26-1.5	21,00	26,00	1,50
VFR 21-28-1.5	21,00	28,00	1,50
VFR 22-27-1.5	22,00	27,00	1,50
VFR 22-29-1.5	22,00	29,00	1,50

**Web:** <http://cat.hansa-flex.com/en/VFR15MM>

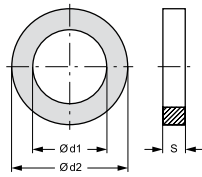
**VFR (2,0 mm)****Vulcanised fibre sealing ring, 2 mm thick**

**Standard:** DIN 7603-A  
**Material:** Vulcanised fibre

Identification	d1 mm	d2 mm	S mm
VFR 6.2-17.5-2	6,20	17,50	2,00
VFR 24-30-2	24,00	30,00	2,00
VFR 26-32-2	26,00	32,00	2,00
VFR 27-32-2	27,00	32,00	2,00
VFR 28-34-2	28,00	34,00	2,00
VFR 30-36-2	30,00	36,00	2,00
VFR 32-38-2	32,00	38,00	2,00

Identification	d1 mm	d2 mm	S mm
VFR 33-39-2	33,00	39,00	2,00
VFR 35-41-2	35,00	41,00	2,00
VFR 36-42-2	36,00	42,00	2,00
VFR 40-47-2	40,00	47,00	2,00
VFR 42-49-2	42,00	49,00	2,00
VFR 45-52-2	45,00	52,00	2,00
VFR 48-55-2	48,00	55,00	2,00

**Web:** <http://cat.hansa-flex.com/en/VFR20MM>



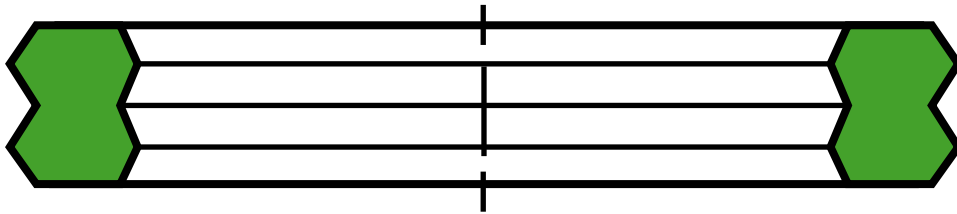

7

## Moulded parts

**Form sealing rings**

Form sealing rings PU

220

**XS AK 353**

## Moulded seals XS AK 353

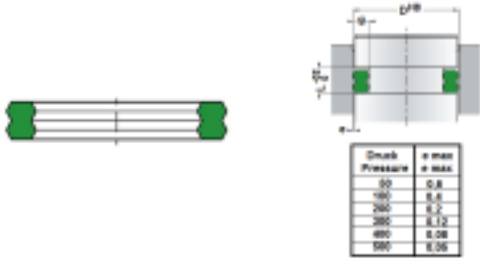

O-ring grooves according to ISO standards may be manufactured in a wide range of dimensions. For sections of 3.53 mm, the groove depth varies according to ISO 2.7 to 3.1 mm. For the best possible seal in all dimension ranges this seal has been developed that can replace conventional O-rings. Interchangeable with O-rings High resistance to extrusion. no anti-extrusion ring required

**Design:** Sealing ring  
**Operating pressure:** up to 500 bar  
**Temp. range:** PU18: -30 °C bis +100 °C, PU33: -40 °C bis + 120 °C

Identification	D (mm)	g (mm)	L (mm)	cross section	Material
				mm	
XS 40 - AK 353	40 to 41.9 mm	2.7 to 3.1 mm		3,53	PU33
XS 42 - AK 353	42 to 43.9 mm	2.7 to 3.1 mm		3,53	PU18
XS 44 - AK 353	44 to 45.9 mm	2.7 to 3.1 mm		3,53	PU33
XS 46 - AK 353	46 to 47.9 mm	2.7 to 3.1 mm		3,53	PU18
XS 48 - AK 353	48 to 49.9 mm	2.7 to 3.1 mm		3,53	PU18
XS 50 - AK 353	50 to 51.9 mm	2.7 to 3.1 mm		3,53	PU33
XS 52 - AK 353	52 to 53.9 mm	2.7 to 3.1 mm		3,53	PU18
XS 54 - AK 353	54 to 55.9 mm	2.7 to 3.1 mm		3,53	PU33
XS 56 - AK 353	56 to 57.9 mm	2.7 to 3.1 mm		3,53	PU18
XS 58 - AK 353	58 to 59.9 mm	2.7 to 3.1 mm		3,53	PU18
XS 60 - AK 353	60 to 62.9 mm	2.7 to 3.1 mm		3,53	PU33
XS 63 - AK 353	63 to 65.9 mm	2.7 to 3.1 mm		3,53	PU33
XS 66 - AK 353	66 to 69.9 mm	2.7 to 3.1 mm		3,53	PU18
XS 70 - AK 353	70 to 72.9 mm	2.7 to 3.1 mm		3,53	PU33
XS 73 - AK 353	73 to 75.9 mm	2.7 to 3.1 mm		3,53	PU33
XS 76 - AK 353	76 to 79.9 mm	2.7 to 3.1 mm		3,53	PU18
XS 80 - AK 353	80 to 84 mm	2.7 to 3.1 mm		3,53	PU33

**Web:** <http://cat.hansa-flex.com/en/XSAK353>

**XS AK 534**

## Moulded seals XS AK 534

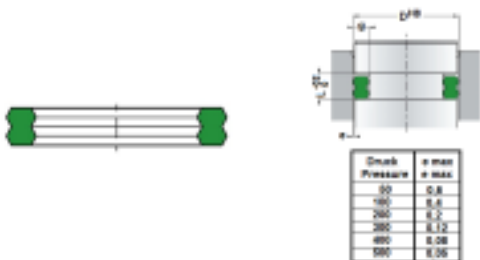

O-ring grooves according to ISO standards may be manufactured in a wide range of dimensions. For sections of 5.34 mm, the groove depth varies according to ISO 2.7 to 3.1 mm. For the best possible seal in all dimension ranges this seal has been developed that can replace conventional O-rings. Interchangeable with O-rings High resistance to extrusion. no anti-extrusion ring required

**Design:** Sealing ring  
**Operating pressure:** up to 500 bar  
**Temp. range:** PU18: -30 °C bis +100 °C, PU33: -40 °C bis + 120 °C

Identification	D (mm)	g (mm)	L (mm)	cross section	Material
				mm	
XS 80 - AK 534	80 to 84.9 mm	4.3 to 4.7 mm		5,34	PU33
XS 85 - AK 534	85 to 89.9 mm	4.3 to 4.7 mm		5,34	PU33
XS 90 - AK 534	90 to 94.9 mm	4.3 to 4.7 mm		5,34	PU33
XS 95 - AK 534	95 to 99.9 mm	4.3 to 4.7 mm		5,34	PU18
XS 100 - AK 534	100 to 104.9 mm	4.3 to 4.7 mm		5,34	PU33
XS 105 - AK 534	105 to 109.9 mm	4.3 to 4.7 mm		5,34	PU18
XS 110 - AK 534	110 to 114.9 mm	4.3 to 4.7 mm		5,34	PU33
XS 115 - AK 534	115 to 119.9 mm	4.3 to 4.7 mm		5,34	PU18
XS 120 - AK 534	120 to 124.9 mm	4.3 to 4.7 mm		5,34	PU18
XS 125 - AK 534	125 to 129.9 mm	4.3 to 4.7 mm		5,34	PU18
XS 130 - AK 534	130 to 135.9 mm	4.3 to 4.7 mm		5,34	PU18
XS 136 - AK 534	136 to 142.9 mm	4.3 to 4.7 mm		5,34	PU18
XS 143 - AK 534	143 to 149.9 mm	4.3 to 4.7 mm		5,34	PU18
XS 150 - AK 534	150 to 157.9 mm	4.3 to 4.7 mm		5,34	PU18
XS 158 - AK 534	158 to 165.9 mm	4.3 to 4.7 mm		5,34	PU18
XS 166 - AK 534	166 to 173.9 mm	4.3 to 4.7 mm		5,34	PU18
XS 174 - AK 534	174 to 181.9 mm	4.3 to 4.7 mm		5,34	PU18
XS 182 - AK 534	182 to 189.9 mm	4.3 to 4.7 mm		5,34	PU18
XS 190 - AK 534	190 to 199.9 mm	4.3 to 4.7 mm		5,34	PU18
XS 200 - AK 534	200 to 210 mm	4.3 to 4.7 mm		5,34	PU18

**Web:** <http://cat.hansa-flex.com/en/XSAK534>



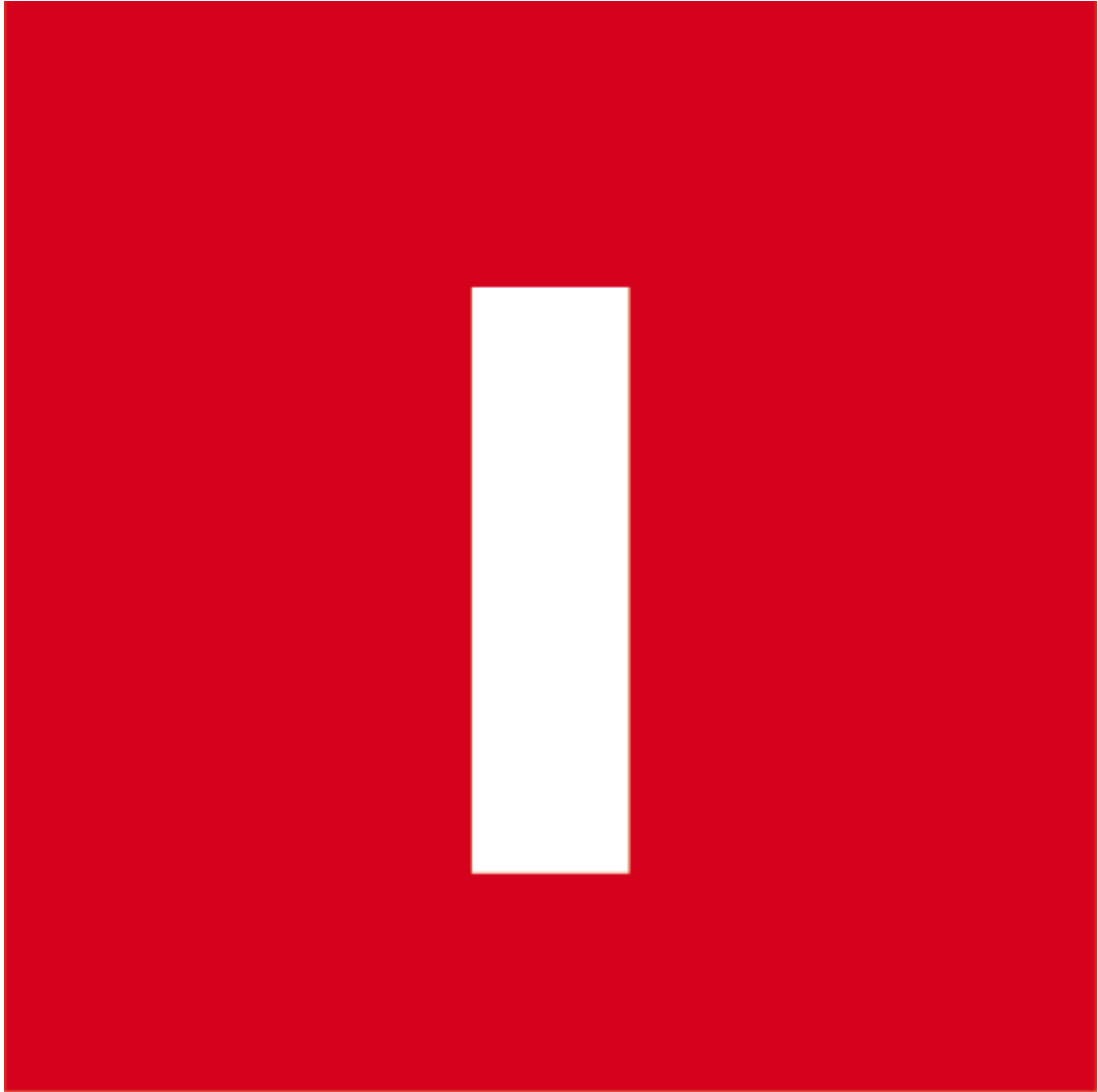

## Subject Index / Index



<b>A</b>	
ALR (1,0 mm)	208
ALR (1,5 mm)	208
ALR (2,0 mm)	209
Aluminium sealing ring	208-209
<b>B</b>	
B Dichtung	42
B FPM-C	45
B FPM-K	44
B GS	46
B M	45
B NEI	43-44
B NEI FPM	43
B NEO	71
B NWO	71
B NWO-KR	72
BK 090	131-132
BK 090 F	132-133
BK-1	126-127
BK-1 F	128
BK-2	129-130
BOERD DI PN16	204
BOX A	183
BOX B	183
BOX C	183
BOX D	184
BOX G	184
BOX H	184
BOX Schnur	185
Boxed set A, norm AS/BS, small	183
Boxed set B, norm AS/BS, large	183
Boxed set C, small metric	183
Boxed set cord & tools	185
Boxed set D, large metric	184
Boxed set G, norm AS/BS, small	184
Boxed set H, small metric	184
BR	189-190
BU	187-188
<b>C</b>	
CAR (1,5 mm)	213
CAR (2,0 mm)	213
CAR (2,5 mm)	214
CAR (3,0 mm)	214
CH	47
CH NEI	48
CH NEO	48
CH1	49
CH2	50
CH3	73
CH3 FPM-C	73
Chevron piston ring CH3	73
Chevron ring CH	47
Chevron ring CH1	49
Chevron ring CH2	50
Chevron ring CH-NEI	48
Chevron ring CH-NEO	48
CIM	136
Combination element NPSL	140
Combination element NPSL-P	140
Complete piston TDO	96
Complete piston TDOP	142-143
Complete piston TDOP FPM	96
Copper ring with asbestos filler, thickness 1,5 mm	213
Copper ring with asbestos filler, thickness 2 mm	213
Copper ring with asbestos filler, thickness 2,5 mm	214
Copper ring with asbestos filler, thickness 3 mm	214
Copper sealing ring set	212
Copper sealing ring, 1 mm thick	210
Copper sealing ring, 1.5 mm thick	210-211
Copper sealing ring, 2 mm thick	211-212
Copper sealing ring, 2.5 - 3.5 mm thick	212
CR (1,0 mm)	210
CR (1,5 mm)	210-211
CR (2,0 mm)	211-212
CR (2,5 - 3,5 mm)	212
CR SET	212
<b>D</b>	
D11W	74
Damping seal	136
DAS	75
DBM	75-77
DBM FPM	77
DBM NEO	77
DDE	78,141
DDEM	79,141
DDEM P	79,141
DDI	51,137
DDIM	51,137
DDIM P	52,138
DEMONTAGE-SET	150
DICHTUNGS PICK SET	150
DICHTUNGS ZANGE	150
Disassembly SET	150
Double wiper DSR-U	100
Double wiper DSR-U-FPM	100
Double wiper DSR-UP	101
DPC	80
DPC NEO	80
DPS	81
DPS FPM	82
DPS SI	82
DR	97
DS	83
DS M	83
DS NEO	84
DSM	85
DSR	98
DSR FPM	99
DSR U	100
DSR U FPM	100
DSR UP	101
DSR-P	99
DUM	53,86,139,142
DUM N	54,86
<b>E</b>	
E-DWR	117
EGR A	87
EGRP A	87
E-GTP	119
E-GTP1	120-121
EU	55-56
EUD	88
EUD P	88
EU-I	56-57
EUS-I	57
<b>F</b>	
FD C4400	202
FDDN PN C4400	203
Flat seal	202
Flat seal, DIN2690 asbestos-free	203
FS	198
FS-BOX	198
<b>G</b>	
GA	102-103
GA FPM	103
GAR ABS	103-104
GPK	89
GPP	142
GPS	90
GPS LP	90
GT	122
GTH	122
GTH ZOLL	123
Guide band GTH	122-123
Guide band, GT	122

Guide WR	125	Piston packing set for one-piece pistons DAS	75
<b>H</b>		Piston packing set for one-piece pistons DBM	75-77
HK DSF	148	Piston packing set for one-piece pistons DBM-FPM	77
HK GKG	147	Piston packing set for one-piece pistons DBM-NEO	77
HK GKG 2S	147	Piston packing set for one-piece pistons DPS	81
HK GKG T	146	Piston packing set for one-piece pistons DPS SI	82
HK KIT	146	Piston packing set for one-piece pistons DPS-FPM	82
<b>I</b>		Piston packing set for one-piece pistons EUD	88
IBF	58	Piston packing set for one-piece pistons EUD.P	88
IBU	58	Piston packing set for one-piece pistons PHD	92
Ice scraper DR	97	Piston packing set for one-piece pistons PHD-PU	92
I-DWR	117-118	Piston packing set for split pistons D11W	74
IGR B	59	Piston packing set for split pistons DPC	80
IGR BPU	59-60	Piston packing set for split pistons DPC-NEO	80
IGRL B	60	Piston packing set for split pistons DSM	85
IGRL BPU	61	Piston packing set, EGR-A	87
I-GTP A	119	Piston packing set, EGRP	87
I-GTP1 A	121	Piston packing set, GPK	89
<b>M</b>		Piston packing set, GPS	90
MBK	191	Piston packing set, GPS-LP	90
Measuring cone for O-rings	149	Piston seal B-NEO	71
Measuring equipment for seal identification	149	Piston seal B-NWO	71
MK	149	Piston seal B-NWO-KR	72
Moulded seals XS AK 353	220	Piston seal DDEM	79,141
Moulded seals XS AK 534	220	Piston seal DS	83
MT	149	Piston seal DS-M	83
MU	62-64,91	Piston seal DS-NEO	84
<b>N</b>		Piston seal RSE	93
NPSL	140	Piston seal RSE-AE	94
NPSL-P	140	Piston seal RSE-W	94
NW	105	Piston seal RSE-W-AR	95
<b>O</b>		Piston seal, DDE	78,141
OR 70° Shore EPDM	181	Piston seal, DDEM-P	79,141
OR 70° Shore NBR	154-167	Piston wiper PPW	106
OR 70° Shore Silicon	181	PLATTE C4400	204
OR 80° Shore FPM	175-180	PPW	106
OR 80° Shore NBR	168	PW G	107
OR 90° Shore NBR	170-174	PW U	107
OR 90° Shore NBR NO	168-169	<b>Q</b>	
OR F-S	181-182	QR (70° Shore NBR)	186
O-ring 70SH EPDM sulphur cured	181	Quad ring 70SH NBR	186
O-ring 80SH FKM (FPM)	175-180	<b>R</b>	
O-ring 80SH NBR	168	Rod guide I-DWR	117-118
O-ring 90 SH NBR NO	168-169	Rod guide I-GTP	119
O-ring 90SH NBR	170-174	Rod guide I-GTP1	121
O-ring cord 75SH FPM	182	Rod seal B	42
O-ring cord, 70SH NBR	182	Rod seal B GS	46
O-ring FEP/silicone	181-182	Rod seal B-FPM/C	45
O-RING PICK SET	151	Rod seal B-FPM/K	44
O-ring pick set	151	Rod seal B-M	45
O-RING PICK SET	151	Rod seal B-NEI	43-44
O-ring pick set	151	Rod seal B-NEI-FPM	43
O-ring set, CAT	185	Rod seal DDI	51,137
O-ring, 70SH NBR	154-167	Rod seal DDIM	51,137
O-ring 70SH silicone	181	Rod seal DDIM-P	52,138
O-Ringschnur 70° Shore NBR	182	Rod seal EU	55-56
O-Ringschnur 75° Shore FPM	182	Rod seal EU-I	56-57
<b>P</b>		Rod seal EUS-I	57
Packing set for hydraulic cylinder DSF	148	Rod seal IBF	58
Packing set HKGKG	147	Rod seal IGR-B	59
Packing set HKGKG2S	147	Rod seal IGRL-B	60
Packing set HKGKG T	146	Rod seal RS-L	65
Packing set HKKIT	146	Rod seal RS-LA	66
PBK	192-194	Rod seal SM	67
PHD	92	Rod seal SM M	67
PHD PU	92	Rod seal TS	68
Piston guide E-DWR	117	Rod seal TS-AI	68
Piston guide E-GTP	119	Rod seal TS-L	69
Piston guide E-GTP1	120-121	Rod seal TS-LA	70
Piston guide WP	124	Rod seal UWR	109
		Rod seal UWR-P	109
		Rod seal, IBU	58
		Rod seal, IGR-BPU	59-60

Rod seal, IGRL-BPU	61
RS L	65
RS LA	66
RSE	93
RSE AE	94
RSE W	94
RSE W-AR	95
<b>S</b>	
SAE flange seal SFS	198-199
Seal box for SAE and ISO flanges, SET	198
Seal for SAE and ISO flanges	198
Seal pick Set	150
Seal pliers	150
Sealing plate, asbestos-free	204
SF SET CAT	185
SFS	198-199
Sliding bush BK090	131-132
Sliding bush BK090-F	132-133
Sliding bush BK-1	126-127
Sliding bush BK-1-F	128
Sliding bush BK-2	129-130
SM	67
SM M	67
Spiral support ring BR	189-190
Support ring BU	187-188
Support ring MBK	191
Support ring PBK	192-194
SWP	108
SWP-I	108
<b>T</b>	
TDO	96
TDO FPM	96
TDOP	142-143
TS	68
TS AI	68
TS L	69
TS LA	70
<b>U</b>	
U- ring DUM-N	54,86
UNI-MESSSCHIEBER	149
Universal Vernier callipers	149
UR / 08BS	195-196
U-ring DUM	53,86,139,142
U-ring MU	62-64,91
Usit ring centred 08BS9	197
Usit ring centred 08BS9-FPM	196
Usit ring, UR	195-196
UWR	109
UWR-P	109
<b>V</b>	
VFR (1,0 mm)	215
VFR (1,5 mm)	215
VFR (2,0 mm)	216
Vulcanised fibre sealing ring, 1 mm thick	215
Vulcanised fibre sealing ring, 1.5 mm thick	215
Vulcanised fibre sealing ring, 2 mm thick	216
<b>W</b>	
WAH	110
Wiper DSR	98
Wiper DSR-FPM	99
Wiper DSR-P	99
Wiper GA	102-103
Wiper GA-FPM	103
Wiper GA-R	103-104
Wiper NW	105
Wiper PW-G	107
Wiper PW-U	107
Wiper SWP	108
Wiper SWP-I	108
Wiper WRM	111
Wiper WRM-FPM	111
Wiper WRM-H	112
Wiper WRM-P	112-113
Wiper WRM-PI	113
Wiper WRS	114
Wiper WTF-A	115
Wiper WTF-B	115
Wiper WTFP-B	116
Wiper WTFP-BPU	116
Wiper, WAH	110
Wiper, WUH	110
WP	124
WR FUEHRUNG	125
WRM	111
WRM FPM	111
WRM-H	112
WRM-P	112-113
WRM-PI	113
WRS	114
WTF A	115
WTF B	115
WTFP B	116
WTFP BPU	116
WUH	110
<b>X</b>	
XS AK 353	220
XS AK 534	220









# Products

Hydraulic hoses



Hose lines in all nominal diameters and for every field of application

Hydraulic steel tubes



Precision tubes conforming to DIN 2391, deliverable as single items or in series

Hose fittings



Comprehensive range of fittings in stock, custom designs at very short notice

Fittings



Many different dimensions and shapes; available in both steel and stainless steel

Couplings



Available immediately from stock; couplings for every conceivable purpose

Metal & PTFE hoses



Special hose lines for solid, liquid and gaseous media

Bellows & expansion joints



Stainless steel and rubber, standard or custom design for your requirements

Industrial hoses



Hoses, fittings and couplings for industrial applications in many sectors

Preformed hoses



Many standard sizes ex warehouse, custom designs for all geometries

Hydraulic cylinders



Many variants available in standard inventory, custom designs at short notice

Hydraulic components



More than 4,500 components available from stock – supply of ready-to-install groups

Power unit manufacture



Innovative solutions in hydraulic drive and control technology

High pressure flanges



Many designs in all standard alloys permanently in stock – up to 6,000 psi and higher

Measuring systems



Extensive range of measuring systems for fluid Technology – analog or digital

Mounting technology



Deliverable materials: polypropylene, polyamide, solid rubber and aluminium

Adapters



Wide range of adapters for optimum flow conditions

Hydraulic seals



More than 8,000 different sealing systems in stock, custom designs available at short notice

Filtration



Filter technology ensures a smooth operation of plants and machinery



# Services

Rapid hydraulics service



Full-service mobile rapid hydraulics service – contactable at no charge, any time

Fluid service



Professional consulting and oil care; provision of filter systems and elements

Industrial assembly



Scheduled activities to avoid unscheduled stoppages

Technical consulting



Individual solutions tuned precisely to the needs of our customers

Engineering/  
Project planning



Planning for entire hydraulic systems – all from a single source

Cylinder repair



Manufacturer-independent repair of cylinders, pumps, motors and valves

Workshop containers



Mobile workshop containers for extreme application areas

Plant-in-plant production



Production facility at the customer's site – perfect synchronisation, rapid response times

Kitting



Ready-to-install, pre-assembled sets – individually adapted to the customer's needs

Kanban

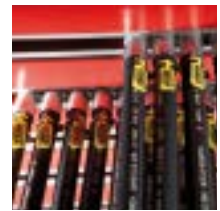

Everything permanently in stock – structured inventory maintained at customer's site

Customer training



Wide-ranging seminar programme on all aspects of fluid technology, also conducted at customer's site

Hose identification



Replacement parts procurement without delay with X-CODE – unique, fast

Online-Shop



24/7 easy shopping, 80,000 items in stock:  
[www.hansa-flex.com/shop](http://www.hansa-flex.com/shop)







**Catalogue 1:  
Hose Technology**

Hoses	
Hose fittings	
Couplings	
Measuring equipment	



**Catalogue 2:  
Connection Technology**

Pipe fittings ISO 8434-1	Mounting technology
Pipes	Accessories and tools
Adapters	
Flanges	
Ball valves	
Measuring equipment	



**Catalogue 3:  
Industrial Technology**

Hoses	Compressed air technology
Hose fittings	Fluid service
Couplings	Accessories and tools
Ball valves	
Mounting technology	
Water technology	



**Pneumatic Products**

Hoses and accessories	Cylinders and control valves
Hose couplings	Service units
Screw fittings and connectors	linear drive technology
Pipeline system Infinity	Vacuum technology
Pressure and temperature measurement	
Valves and shut-off devices	



**Metal Hoses**

Metal hoses	Hose fittings
PTFE hoses	
Wound hoses	
Coolant hoses	
Expansion joints	
Hose protection	



**Hydraulic Components**

Hydraulic components	Tanks
Pumps	High-pressure hydraulics 700 bar
Hydraulic motors	Cylinders and cylinder components
Valves	Electric motors
Pressure accumulators	Filtration
Heat exchangers	Measuring equipment

